

Haymaking | Fenaison

# MOUNTED MOWERS FAUCHEUSES PORTÉES

DM - DMC ROLL - ENOSTORM 300



AGRICULTURAL MACHINERY  
**enorossi**

ENG-FRA

# MOUNTED MOWERS FAUCHEUSES PORTÉES

DM - DMC ROLL - ENOSTORM 300



Your ideas, Our products



WATCH VIDEO



DM



WATCH VIDEO



DMC ROLL



WATCH VIDEO



ENOSTORM 300



The mounted disc mowers are professional machines, agile in use and made to ensure a high productivity and long life. They are all equipped with the ENOCUT cutting bar which allows a quick and clean cut. The DM series, with lateral oscillating cutting bars, ensures a uniform cut on all types of terrain. DMC ROLL series mounts the roller conditioner to facilitate the drying of the product. The ENOSTORM 300 front mower thanks to the lightening springs with lateral oscillation and to the system break-proof "Pull back" allows safe work without interruptions and excellent ground adaptation.

*Les faucheuses à disques portées sont des machines professionnelles conçues pour assurer une productivité élevée et une longue durée de vie. Elles sont équipées de la barre ENOCUT qui permet une coupe rapide et nette. La série DM, avec barre de coupe oscillante latérale, assure une coupe uniforme sur tous les types de terrain. La série DMC ROLL avec le conditionneur à rouleaux facilite le séchage du produit. La faucheuse frontale ENOSTORM 300, grâce aux ressorts d'allègement à oscillation latérale et au système anti-casse «Pull back», permet un travail sûr, sans interruption, et une excellente adaptation au sol.*

## MAIN FEATURES

## CARACTÉRISTIQUES PRINCIPALES



### Cutting bar ENOCUT

### Barre de coupe ENOCUT

#### High quality cutting bar ENOCUT

*Barre de coupe ENOCUT de haute qualité*

The ENOCUT cutting bar is a special system specially designed for all cutting bars in our range of mowers. It allows a quick and clean cut.

*La barre de coupe ENOCUT est un système spécial conçu pour toutes les barres de coupe de notre gamme de faucheuses. Elle permet une coupe rapide et nette.*

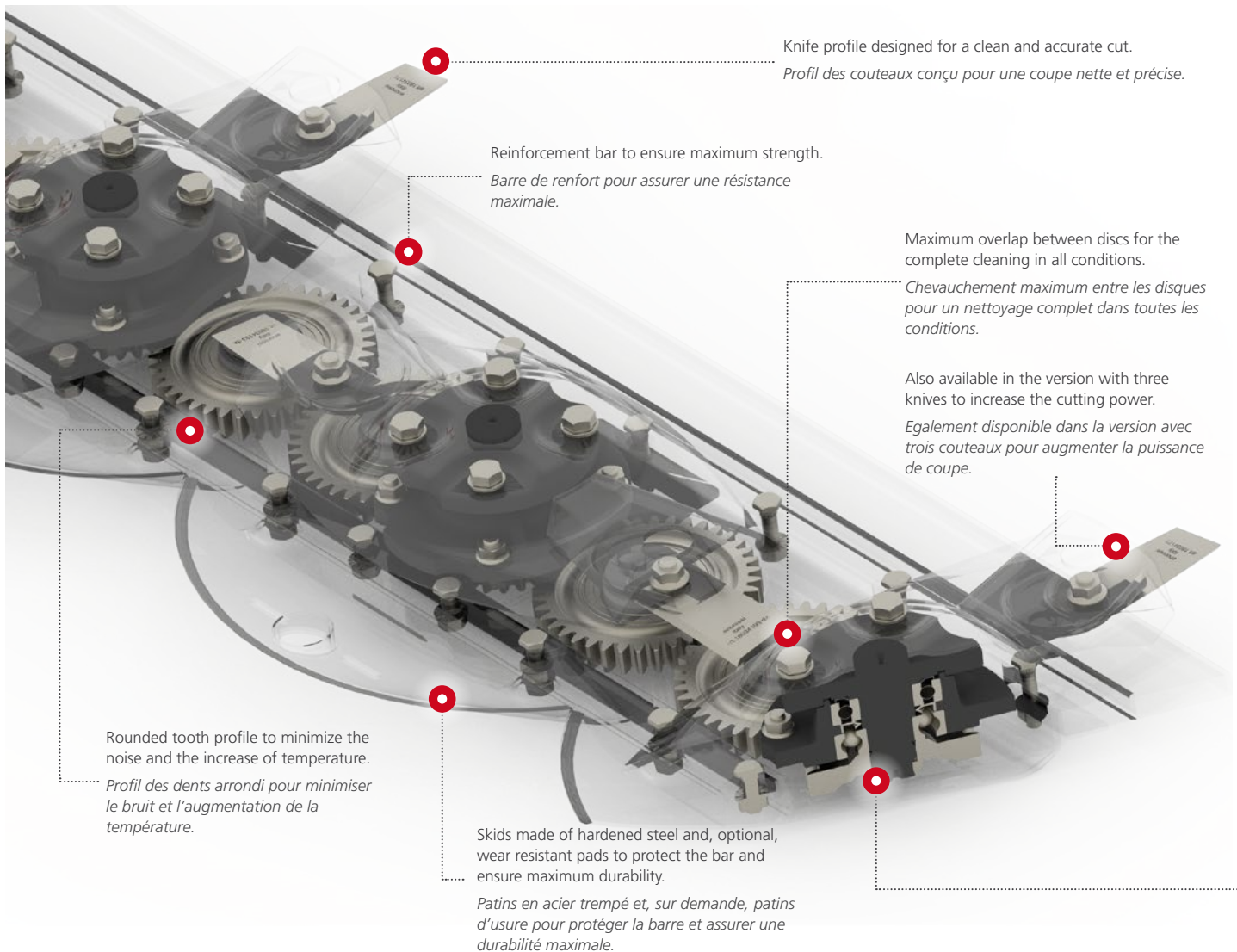

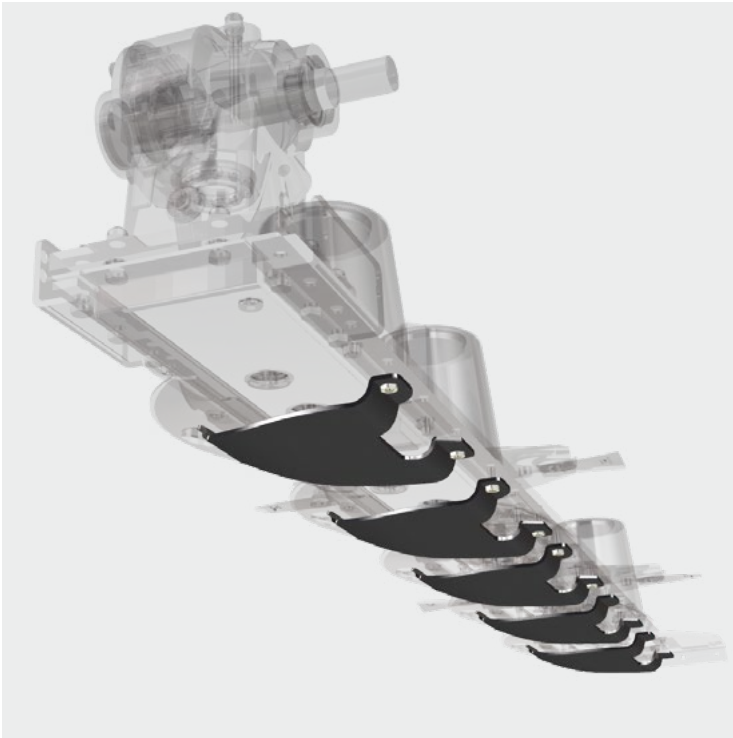

Wear resistant pads (optional).  
*Patins anti-usure (sur demande).*



Conveyor cone for narrow swath (standard).  
*Cône convoyeur pour andain étroit (de série).*

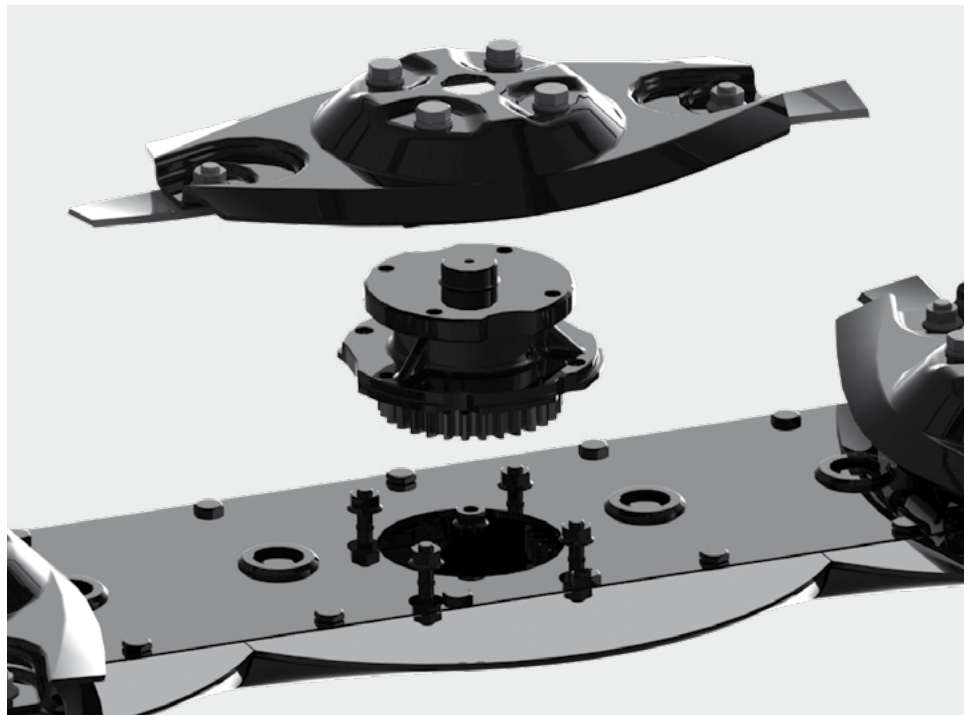

Safety shear hub for protection of the gear bar.  
*Section de sécurité pour la protection des engrenages.*

## MAIN FEATURES

## CARACTÉRISTIQUES PRINCIPALES

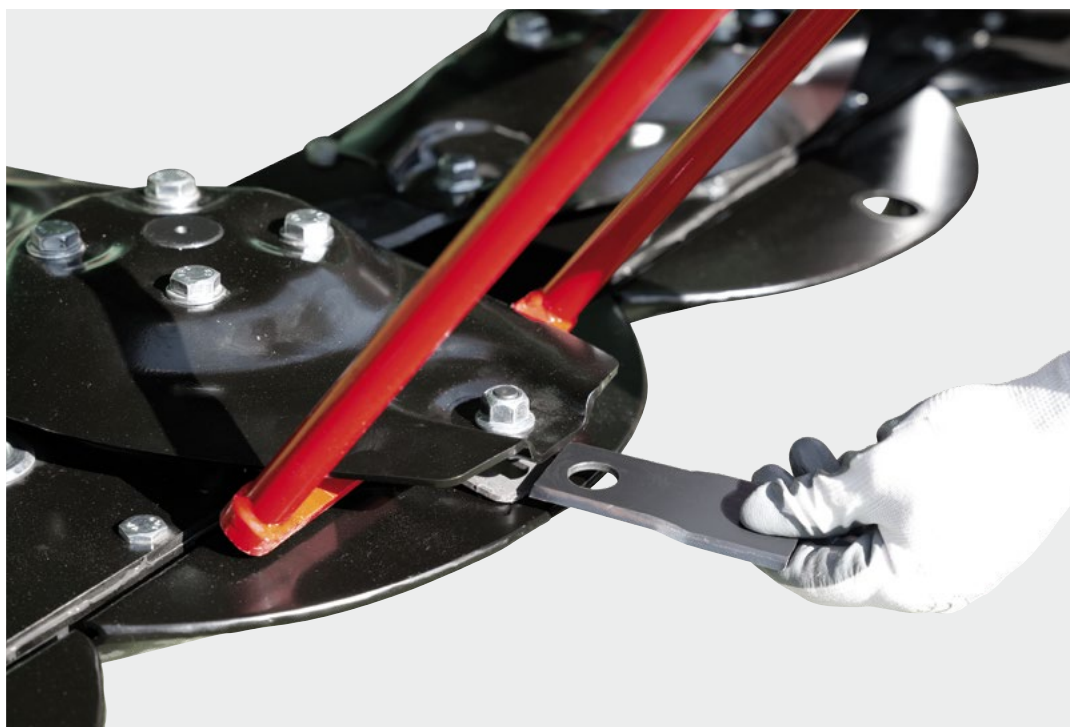

### Quick knife change (optional) *Remplacement rapide des couteaux (sur demande)*

Using a suitable tool, you can press the knife disc down and change the knives easily. A quick and safe system. Available only in the version with two knives per disc.

*En utilisant un outil approprié, vous pouvez appuyer sur le disque et changer les couteaux facilement. Un système sûr et rapide. Disponible uniquement dans la version avec deux lames par disque.*

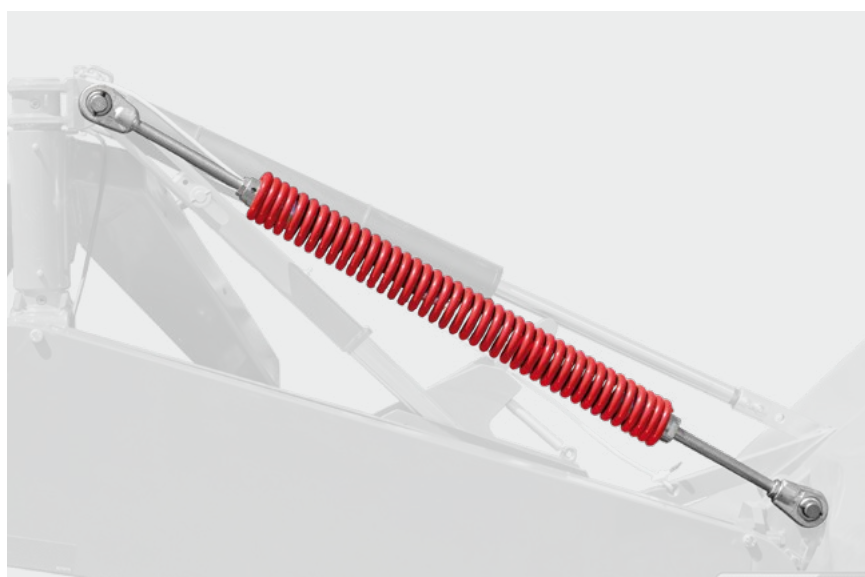

### Lightening spring *Ressorts d'allègement*

In all mounted mowers there are lightening springs that allow the load to be transferred from the mower to the tractor, so as to reduce the pressure on the ground as much as possible.

*Toutes les faucheuses portées sont équipées des ressorts d'allègement qui permettent de transférer la charge de la faucheuse au tracteur, minimisant la pression sur le sol.*



### Safety release<sup>(1)</sup> *Décrochage de sécurité<sup>(1)</sup>*

When it hits an obstacle, the mower rotates backwards, absorbing the impact. When the tractor is reversed, the safety system is reactivated and the mower is returned to the working position.

*Lorsque la faucheuse heurte un obstacle, elle tourne vers l'arrière pour absorber l'impact. Quand le tracteur recule, le système de sécurité est réactivé et la machine revient à sa position de travail.*



## Reduced overall dimensions<sup>(1)</sup> Encombrement réduit<sup>(1)</sup>

Thanks to the reduced size of the frame, it is possible to close the machine for transport without having to get off the tractor.

Grâce à l'encombrement réduit du châssis, il est possible de fermer la machine pour le transport sans avoir à descendre du tracteur.

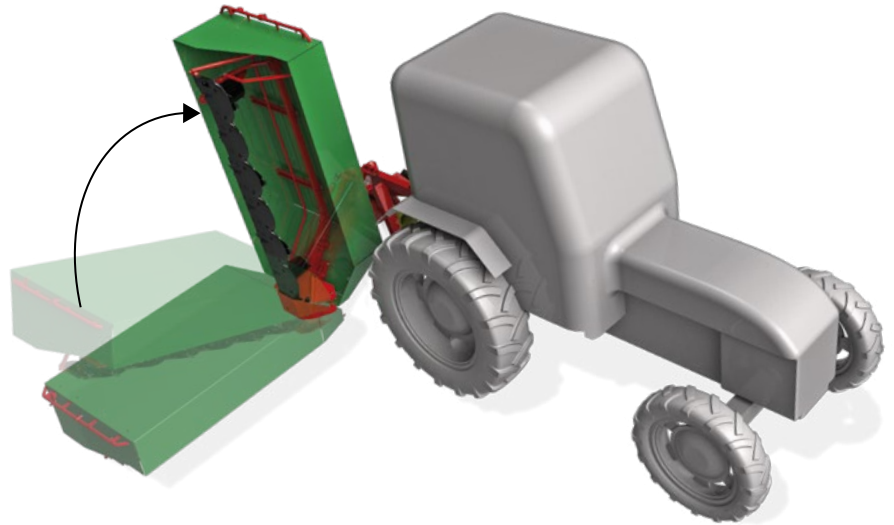

## Lights Kit<sup>(1)</sup> (optional) Kit feux<sup>(1)</sup> (sur demande)

Comfortable and modern light kit to move safely even on the road.

Kit feux confortable et moderne pour se déplacer en toute sécurité même sur la route.



## Belt tensioner spring<sup>(1)</sup> Ressort tendeur de courroie<sup>(1)</sup>

Mechanical device for easy control and adjustment of the belt tension.

Dispositif mécanique pour contrôle et réglage faciles de la tension des courroies.



## Angle of inclination Angle d'inclinaison

On all models of mounted mowers, the bar adapts to the inclinations of the ground, allowing cutting operations to be carried out even in difficult ground conditions. We recommend using the machine tilted for a very short time.

Sur tous les modèles de faucheuses portées, la barre s'adapte aux inclinaisons du sol, permettant d'effectuer les opérations de coupe même dans des conditions difficiles. Nous vous recommandons d'utiliser la machine inclinée pendant une durée très courte.

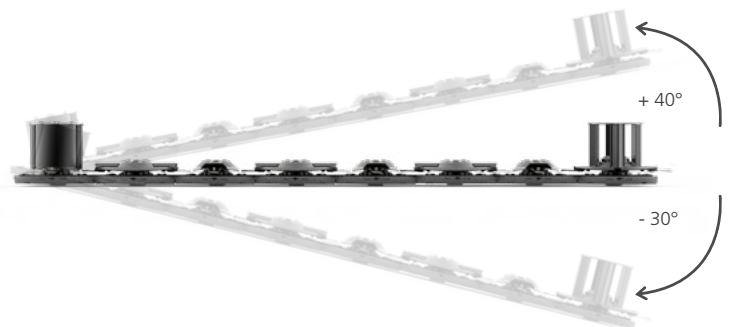

<sup>(1)</sup> Available only for DM and DMC ROLL models

<sup>(1)</sup> Disponible uniquement pour les modèles DM et DMC ROLL

**DM**

## Disc mower

Faucheuse à disques



Easy control and adjustment of **belt tension**.  
*Contrôle et réglage faciles de la **tension des courroies**.*



**Lightening spring** to optimize ground pressure.  
*Ressort d'allègement pour optimiser la pression au sol.*

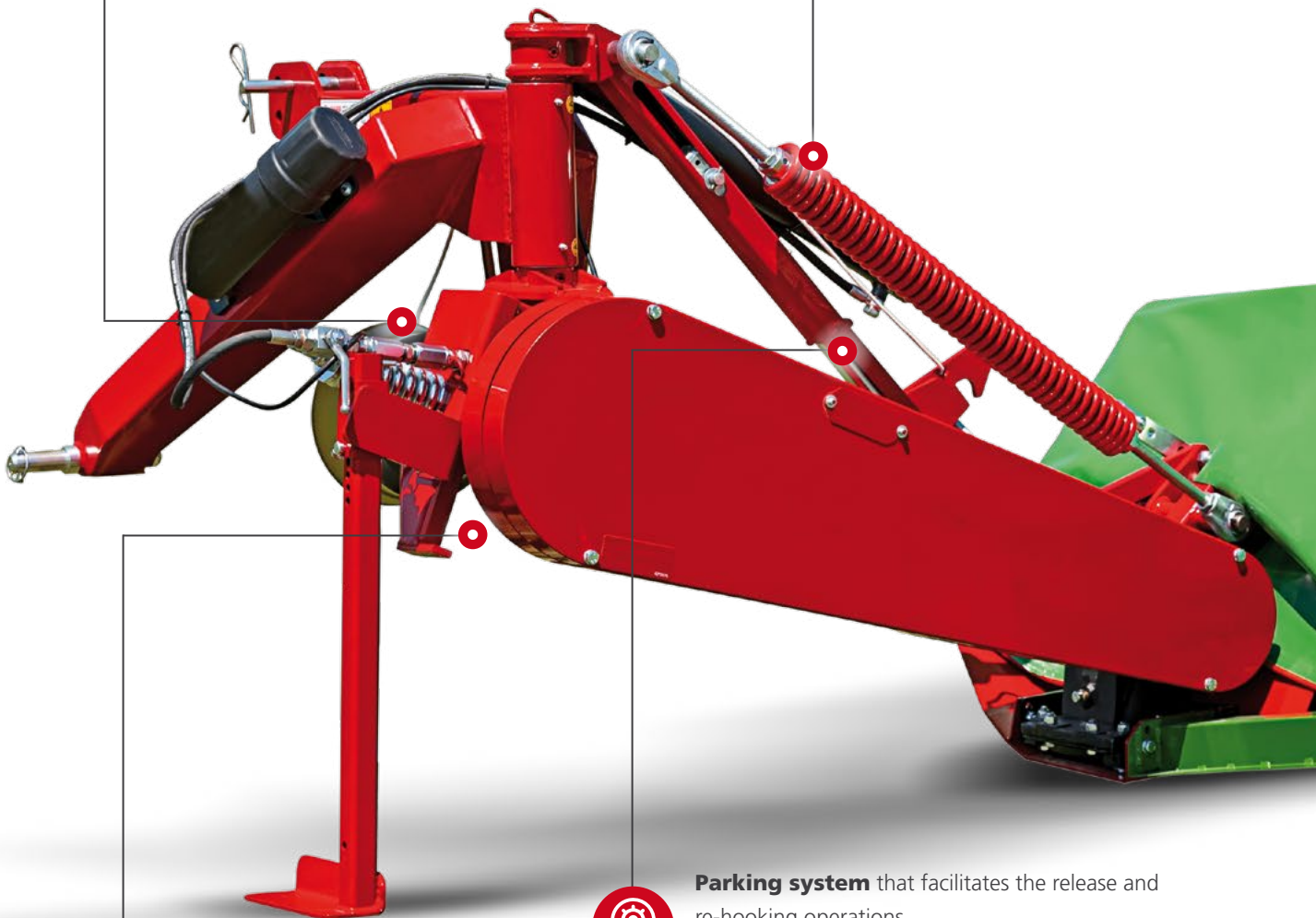

**Parking system** that facilitates the release and re-hooking operations.

***Système de stationnement** qui facilite les opérations d'accrochage et décrochage.*



**Safety release** for machine protection.  
***Décrochage de sécurité** pour protéger la machine.*



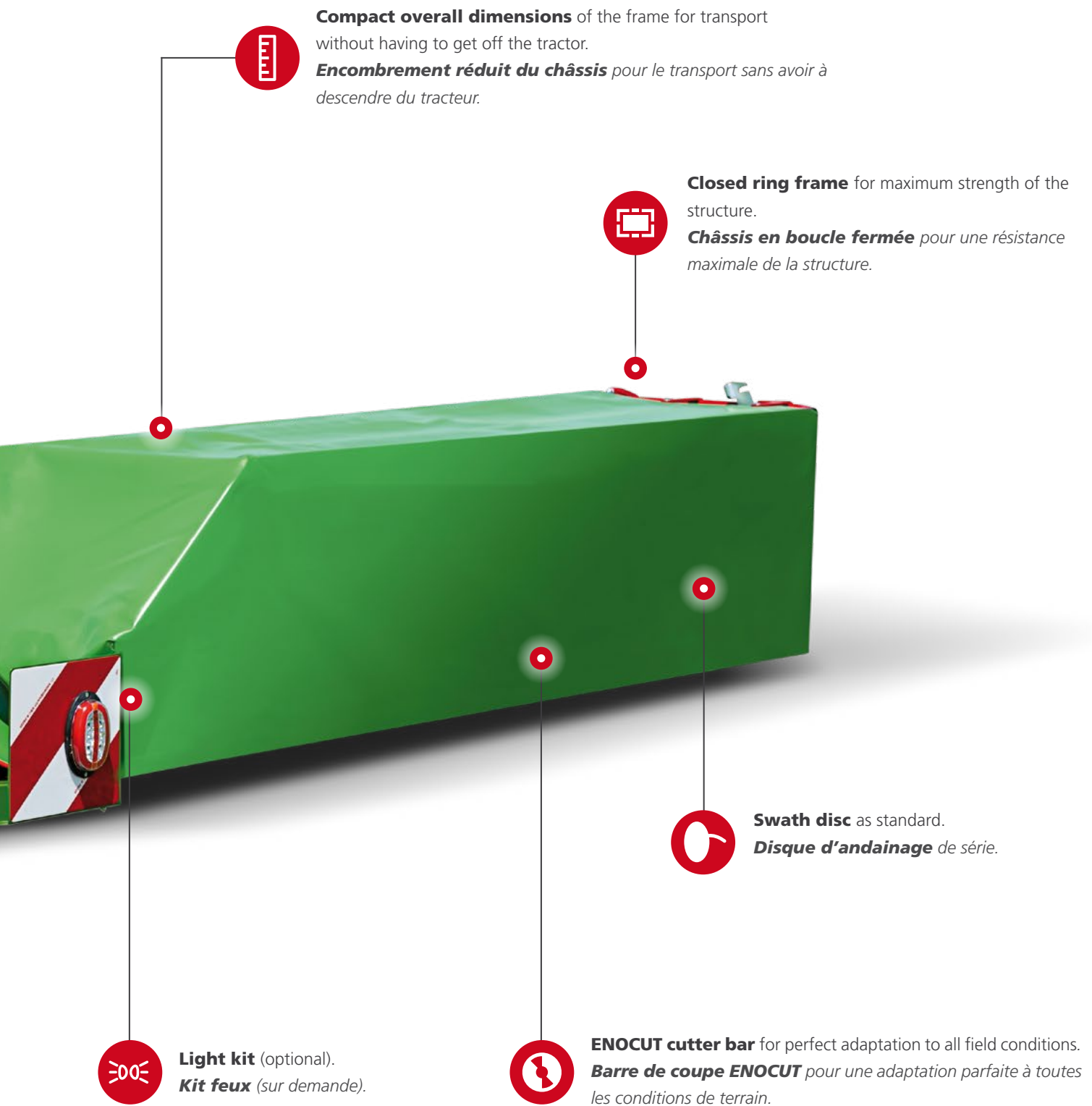

**Compact overall dimensions** of the frame for transport without having to get off the tractor.  
**Encombrement réduit du châssis** pour le transport sans avoir à descendre du tracteur.



**Closed ring frame** for maximum strength of the structure.  
**Châssis en boucle fermée** pour une résistance maximale de la structure.



**Light kit** (optional).  
**Kit feux** (sur demande).



**Swath disc** as standard.  
**Disque d'andainage** de série.



**ENOCUT cutter bar** for perfect adaptation to all field conditions.  
**Barre de coupe ENOCUT** pour une adaptation parfaite à toutes les conditions de terrain.

# DM

## Disc mower

Faucheuse à disques



The DM series adapts perfectly to any type of terrain and allows uniform and fast mowing.

Its agile use makes it suitable for quick and safe work.

*La série DM s'adapte parfaitement à tout type de terrain et permet une coupe régulière et rapide. Son utilisation agile rend ces machines idéales pour un travail rapide et sûr.*

— Closed ring frame for maximum strength of the structure.  
*Châssis en boucle fermée pour une résistance maximale de la structure.*



— Double adjustable swath disc for DM7 and DM8 (optional).  
*Double disque d'andainage réglable pour DM7 et DM8 (sur demande)*



















— Standard swath disc for narrower swath.  
*Disque d'andainage de série pour andain étroit.*



— Additional conveyor cone for narrow swath for DM5 and DM7 (optional).  
*Cône convoyeur supplémentaire pour andain étroit pour DM5 et DM7 (sur demande).*

# Technical Data / Données techniques

	DM4	DM4 3C	DM5	DM6	DM6 3C	DM7	DM8	DM8 3C
 <b>Working width</b> Largeur de travail	167 cm. 7.8 ft.	167 cm. 9.6 ft.	205 cm. 10.5 ft.	245 cm. 7.8 ft.	245 cm. 7.8 ft.	280 cm. 9.6 ft.	320 cm. 10.5 ft.	320 cm. 10.5 ft.
 <b>Transport width (from center)</b> Larg. de transport (du centre)	126 cm. 7.8 ft.	126 cm. 9.6 ft.	126 cm. 10.5 ft.	126 cm. 7.8 ft.	126 cm. 7.8 ft.	132 cm. 9.6 ft.	132 cm. 10.5 ft.	132 cm. 10.5 ft.
 <b>Number of discs</b> Nbre de disques	4	4	5	6	6	7	8	8
 <b>No. of knives</b> Nbre de couteaux	8	12	10	12	18	14	16	24
 <b>Dimensions of the knives</b> Dimensions des couteaux	45x112 mm 1.77-3.54 inch.							
 <b>Cutting height min.</b> Hauteur de coupe min.	45 mm 1.77 inch.							
 <b>Angle of inclination</b> Angle d'inclinaison	-30°/+40°							
 <b>Average swath width</b> Largeur moyenne d'andain	90 cm. 3 ft.	90 cm. 3 ft.	130 cm. 4.3 ft.	165 cm. 5.4 ft.	165 cm. 5.4 ft.	205 cm. 6.7 ft.	240 cm. 7.9 ft.	240 cm. 7.9 ft.
 <b>Rotation of discs</b> Rotation des disques	In pairs combined / Combiné deux à deux							
 <b>Disc rotation speed</b> Vitesse de rotation du disque	3000 rpm							
 <b>Transport height</b> Hauteur de transport	210 cm. 6.9 ft.	210 cm. 6.9 ft.	247 cm. 8.1 ft.	285 cm. 9.4 ft.	285 cm. 9.4 ft.	322 cm. 10.5 ft.	360 cm. 11.8 ft.	360 cm. 11.8 ft.
 <b>PTO speed</b> Vitesse PDF	540 rpm							
 <b>PTO power min. request</b> Puissance PDF requise min.	50 HP	50 HP	50-60 HP	50-60 HP	50-60 HP	70-80 HP	80-90 HP	80-90 HP
 <b>Weight</b> Poids	420 kg 926 Lbs.	430 kg 948 Lbs.	460 kg 1015 Lbs.	500 kg 1100 Lbs.	515 kg 1130 Lbs.	640 kg 1410 Lbs.	690 kg 1520 Lbs.	710 kg 1560 Lbs.
 <b>Right swath disc</b> Disque d'andainage droit	Standard / Standard							
 <b>Safety release</b> Décrochage de sécurité	Standard / Standard							
 <b>Lightening</b> Allègement	Spring / Ressort							

## OPTIONAL / SUR DEMANDE

<b>Double adjustable right swathing disc</b> Double disque d'andainage droit réglable	-	-	-	-	-	•	•	•
<b>Double adjustable left swathing disc</b> Double disque d'andainage gauche réglable	-	-	-	-	-	•	•	•
<b>Protective skids</b> Patins de protection	•	•	•	•	•	•	•	•
<b>Additional conveyor cone</b> Cône convoyeur supplémentaire	-	-	•	-	-	•	-	-
<b>Quick-change knives</b> Couteaux à remplacement rapide	•	-	•	•	-	•	•	-
<b>Light kit</b> Kit feux	•	•	•	•	•	•	•	•

• Available / Disponible - Not available / Non disponible

# DMC ROLL

## Disc mower with conditioner

Faucheuse à disques avec conditionneur



**Double lightening spring** to optimize ground pressure.

**Double ressort d'allègement** pour optimiser la pression au sol.



**Compact overall dimensions** of the frame for transport without having to get off the tractor.

**Encombrement réduit du châssis** pour le transport sans avoir à descendre du tracteur.



**Light kit** (optional).

**Kit feux** (sur demande).



**Cardan** with torque limiter to protect the conditioner.

**Cardan** avec limiteur de couple pour protéger le conditionneur.



Easy control and adjustment of **belt tension**.

Contrôle et réglage faciles de la **tension des courroies**.



**Parking system** that facilitates the release and re-hooking operations.

**Système de stationnement** qui facilite les opérations d'accrochage et décrochage.



Rubber roller **conditioner** (standard).

**Conditionneur** à rouleaux en caoutchouc (de série)

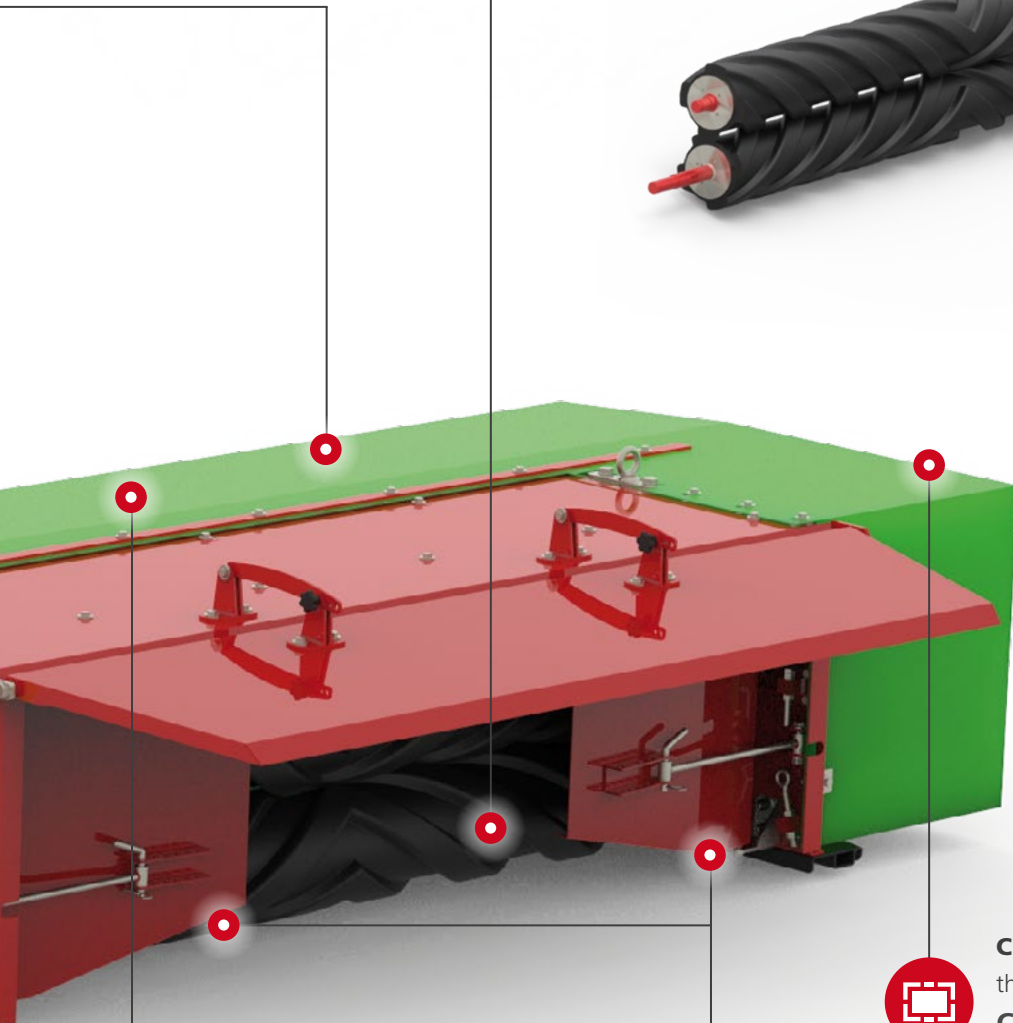

**Closed ring frame** for maximum strength of the structure.

**Châssis en boucle fermée** pour une résistance maximale de la structure.



Swath adjustment **deflectors**.

**Défecteurs** de réglage d'andain.



**ENOCUT cutter bar** for perfect adaptation to all field conditions.

**Barre de coupe ENOCUT** pour une adaptation parfaite à toutes les conditions de terrain.

# DMC ROLL

## Disc mower with conditioner

Faucheuse à disques avec conditionneur



The DM ROLL series offers the rubber roller conditioner to facilitate the drying of the grass. Its agile use makes it suitable for quick and safe work.

*La série DM ROLL est équipée d'un conditionneur à rouleaux en caoutchouc pour faciliter le séchage de l'herbe. Son utilisation agile rend ces machines idéales pour un travail rapide et sûr.*

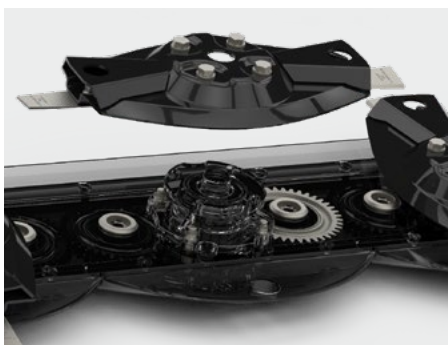

### Special disc for conditioner

The disc is more robust with a specific reinforcement that allows the launch of the product inside the ROLL rollers helping the work and therefore the forward speed.

#### Disque spécial pour conditionneur

*Le disque est robuste et équipé d'un renfort spécifique qui permet l'entrée du produit à l'intérieur des rouleaux ROLL, facilitant le travail et donc la vitesse d'avancement.*



### Gear transmission

In the ROLL conditioner, the gear transmission system allows the two rubber rollers to be kept in phase continuously in the event that they encounter large foreign bodies.

#### Transmission par engrenages

*Dans le conditionneur ROLL, le système de transmission par engrenages permet de maintenir en phase les deux rouleaux en caoutchouc en cas de collision avec des obstacles.*

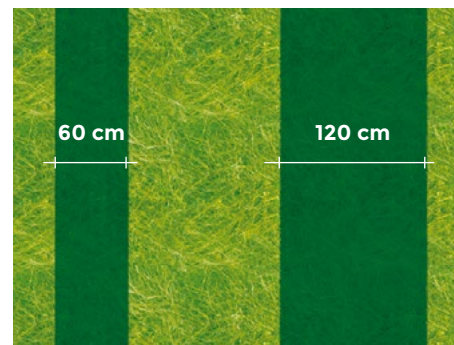





















### Swath adjustment deflectors

The DMC ROLL mowers have two rear deflectors that adjust the swath width which can be 60 cm at least and 120 cm maximum.

#### Défecteurs de réglage d'andain.

*Les faucheuses DMC ROLL disposent de deux déflecteurs arrière qui règlent la largeur de l'andain qui peut être de min. 60 cm. à max. 120 cm.*

# Technical Data / Données techniques

	DMC 5 ROLL	DMC 6 ROLL	DMC 6 3C ROLL
 <b>Working width</b> Largeur de travail	205 cm 6.7 ft.	245 cm 8 ft.	245 cm 8 ft.
 <b>Transport width (from center)</b> Largeur de transport (du centre)	129 cm 4.2 ft.	129 cm 4.2 ft.	129 cm 4.2 ft.
 <b>Number of discs</b> Nbre de disques	5	6	6
 <b>No. of knives</b> Nbre de couteaux	10	12	18
 <b>Dimensions of the knives</b> Dimensions des couteaux	45x112 mm 1.77-3.54 inch.	45x112 mm 1.77-3.54 inch.	45x112 mm 1.77-3.54 inch.
 <b>Cutting height min.</b> Hauteur de coupe min.	45-90 mm 1.77-3.54 inch.	45-90 mm 1.77-3.54 inch.	45-90 mm 1.77-3.54 inch.
 <b>Angle of inclination</b> Angle d'inclinaison	-30°/+40°	-30°/+40°	-30°/+40°
 <b>Conditioning system</b> Système de conditionneur	Rollers Rouleaux	Rollers Rouleaux	Rollers Rouleaux
 <b>Conditioner speed</b> Vitesse conditionneur	900 rpm	900 rpm	900 rpm
 <b>Conditioner width</b> Largeur du conditionneur	138 cm 4.5 ft.	175 cm 5.75 ft.	175 cm 5.75 ft.
 <b>Distance of the working rollers appr.</b> Distance des rouleaux de travail env.	5-20 mm 0.2-8 inch.	5-20 mm 0.2-8 inch.	5-20 mm 0.2-8 inch.
 <b>Maximum distance between rollers</b> Distance maximale entre les rouleaux	80 mm 3.2 inch.	80 mm 3.2 inch.	80 mm. 3.2 inch.
 <b>Average swath width</b> Largeur moyenne d'andain	75-120 cm 2.5-3.9 ft.	90-145 cm 3-4.75 ft.	90-145 cm 3-4.75 ft.
 <b>Rotation of discs</b> Rotation des disques	In pairs combined Combiné deux à deux	In pairs combined Combiné deux à deux	In pairs combined Combiné deux à deux
 <b>Disc rotation speed</b> Vitesse de rotation du disque	3000 rpm	3000 rpm	3000 rpm
 <b>Transport height</b> Hauteur de transport	245 cm 8 ft.	280 cm 9.2 ft.	280 cm 9.2 ft.
 <b>PTO speed</b> Vitesse PDF	540 rpm	540 rpm	540 rpm
 <b>PTO power min. request</b> Puissance PDF requise min.	80-90 HP	90-100 HP	90-100 HP
 <b>Weight</b> Poids	800 kg 1760 Lbs.	850 kg 1875 Lbs.	865 kg 1910 Lbs.
 <b>Safety release</b> Décrochage de sécurité	Standard / Standard	Standard / Standard	Standard / Standard
 <b>Lightening</b> Allègement	2 Springs / 2 Ressorts	2 Springs / 2 Ressorts	2 Springs / 2 Ressorts

## OPTIONAL / SUR DEMANDE

<b>Protective skids</b> Patins de protection	•	•	•
<b>Quick-change knives</b> Couteaux à remplacement rapide	•	•	-
<b>Light kit</b> Kit feux	•	•	•

• Available / Disponible - Not available / Non disponible

Design and/or specifications are subject to change without notification.  
Enorossi se réserve le droit de modifier les caractéristiques et les spécifications techniques à tout moment et sans préavis.

# ENOSTORM 300

## Front disc mower

Faucheuse à disques pour tracteurs en trois points avant



**Lightening spring** to optimize ground pressure.  
**Ressort d'allègement** pour optimiser la pression au sol.



**Anti-breakage "Pull Back"** system and lateral swing.  
**Système anti-casse "Pull Back"** et oscillation latérale.

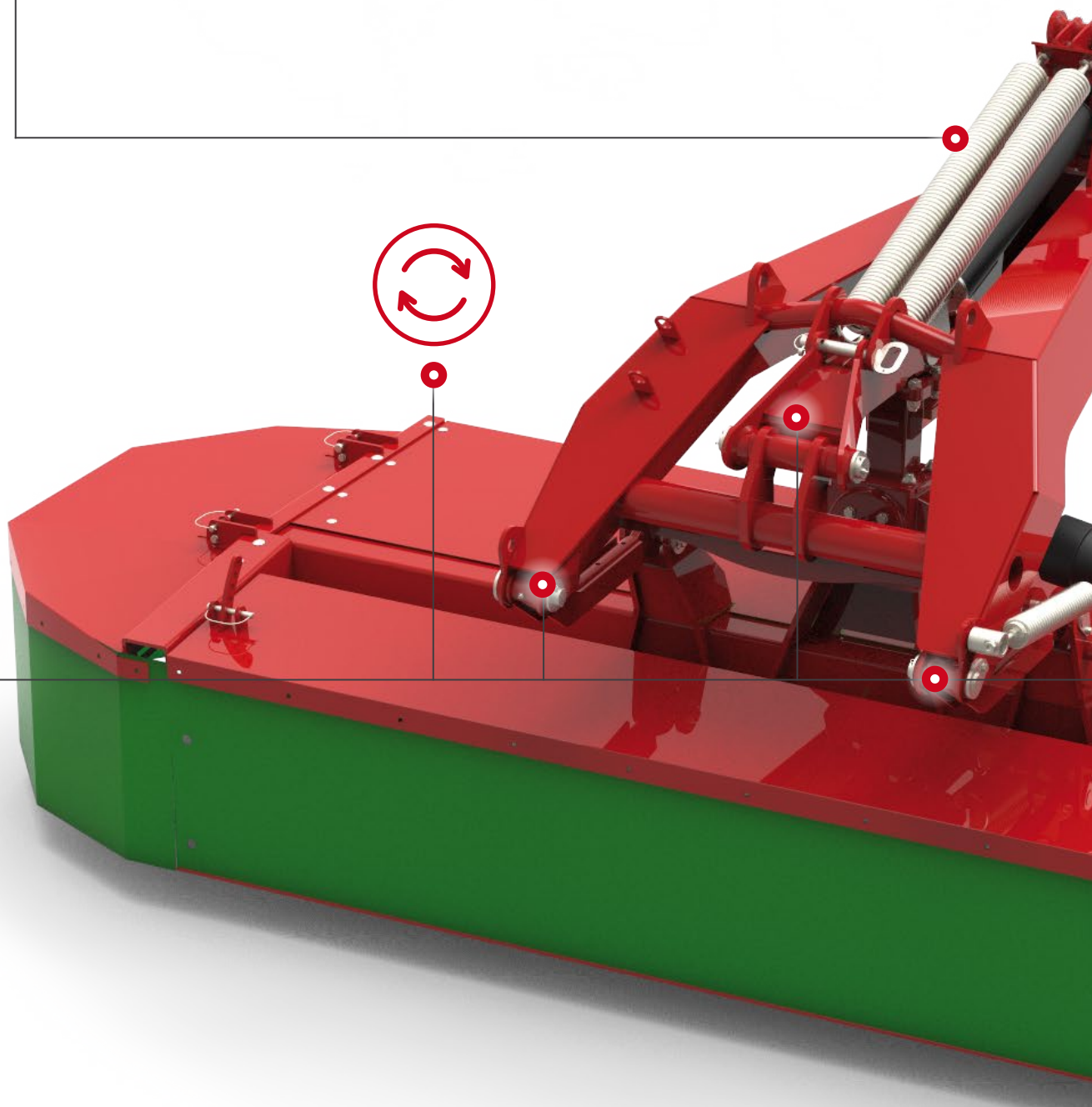





**Double swath disc** on the right and left as standard.  
**Double disque d'andainage** droit et gauche de série.

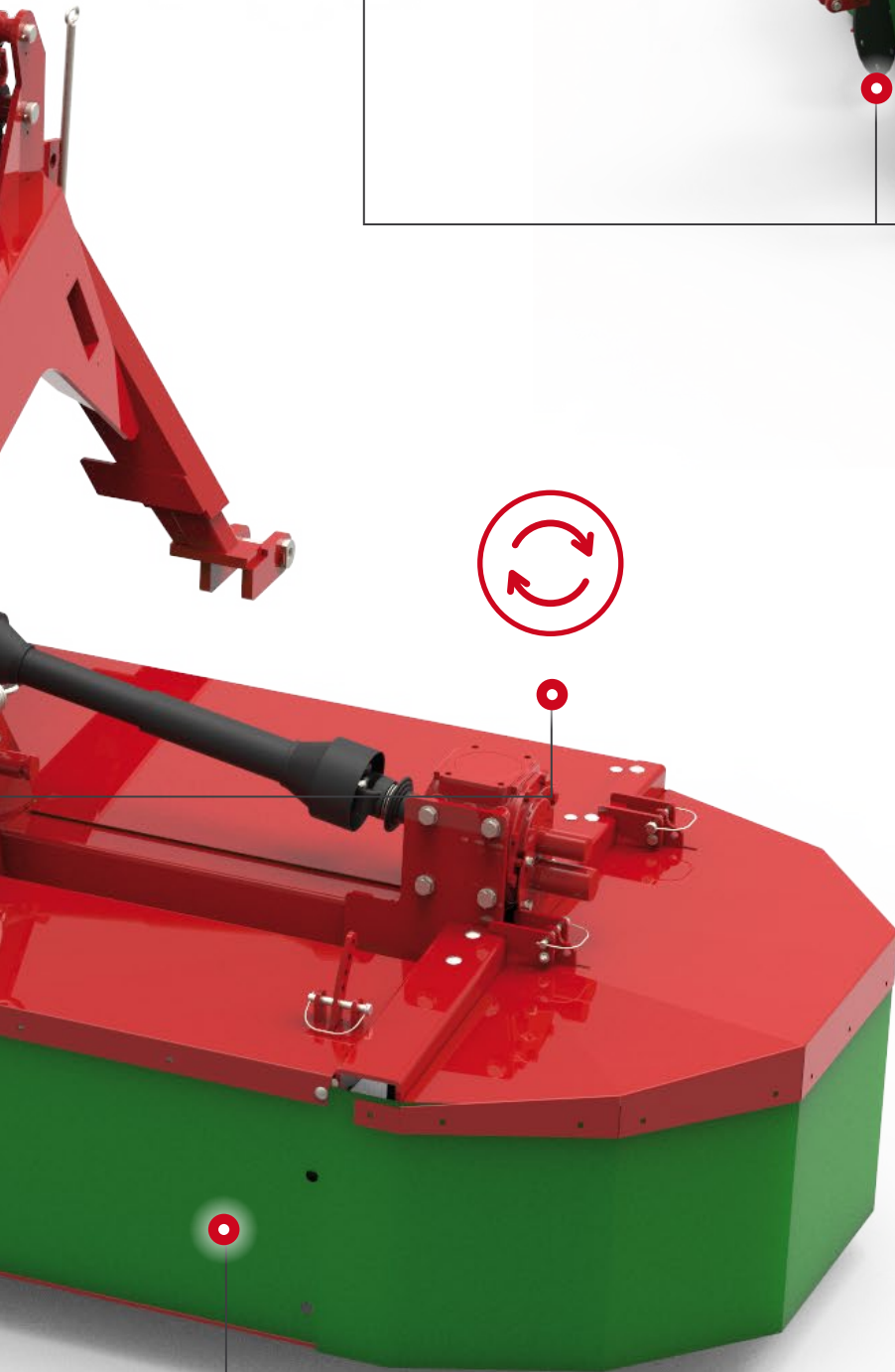
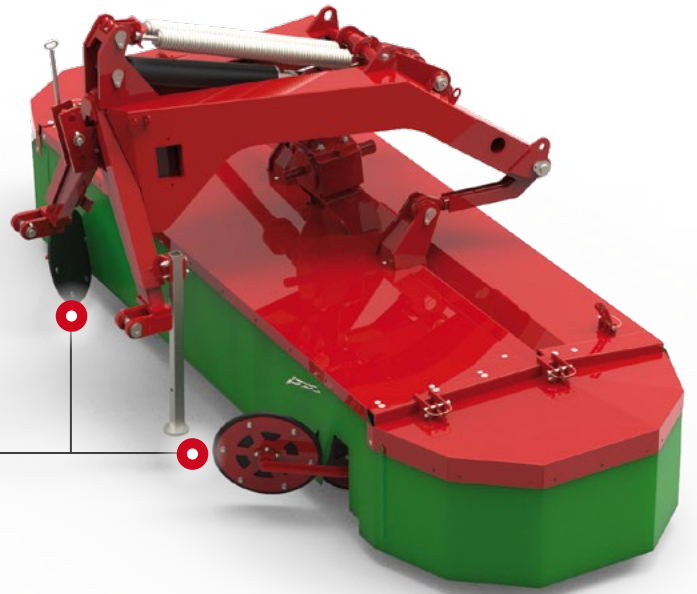

**ENOCUT cutter bar** for perfect adaptation to all field conditions.  
**Barre de coupe ENOCUT** pour une adaptation parfaite à toutes les conditions de terrain.

# ENOSTORM 300

## Front disc mower

Faucheuse à disques pour tracteurs en trois points avant



The ENOSTORM 300 front mower fits perfectly to any type of terrain and allows uniform and fast mowing.

*La faucheuse frontale ENOSTORM 300 s'adapte parfaitement à tout type de terrain et permet une coupe uniforme et rapide.*



## “Pull Back” break-proof system

### Système anti-casse “Pull Back”

The “Pull back” system is activated, together with the lightening springs, whenever the cutting bar encounters obstacles, pushing it backwards and upwards by means of the parallelogram and then automatically returning to the working position. As a result, the work is safer and uninterrupted.

*Le système “Pull back” est activé, conjointement aux ressorts d'allègement, chaque fois que le système de coupe rencontre des obstacles, en la poussant vers l'arrière et vers le haut par le parallélogramme, avant de revenir automatiquement en position de travail. En conséquence, le travail est plus sûr et plus fluide.*





















— Transport position.  
Position de transport

## Technical Data / Données techniques

### ENOSTORM 300

	<b>Working width</b> Largeur de travail	300 cm. 9.85 ft.
	<b>Transport width</b> Larg. de transport	300 cm. 9.85 ft.
	<b>Number of discs</b> Nbre de disques	7
	<b>No. of knives</b> Nbre de couteaux	14
	<b>Dimensions of the knives</b> Dimensions des couteaux	45x112 mm 1.77-3.54 inch.
	<b>Cutting height min.</b> Hauteur de coupe min.	45 mm 1.77 inch.
	<b>Angle of inclination</b> Angle d'inclinaison	+/- 15°
	<b>Average swath width</b> Largeur moyenne d'andain	180 cm. 5.90 ft.
	<b>Rotation of discs</b> Rotation des disques	Converging to the center / <i>Converge vers le centre</i>
	<b>Disc rotation speed</b> Vitesse de rotation du disque	3000 rpm
	<b>Transport height</b> Hauteur de transport	130 cm. 4.3 ft.
	<b>PTO speed</b> Vitesse PDF	1000 rpm
	<b>PTO power min. request</b> Puissance PDF requise min.	90 HP
	<b>Weight</b> Poids	910 kg 2000 Lbs.
	<b>Double swath disc on both sides</b> Double disque d'andainage des deux côtés	Standard / <i>Standard</i>
	<b>Lightening</b> Allègement	Spring / <i>Ressort</i>

### OPTIONAL / SUR DEMANDE

#### Protective skids

Patins de protection

•

#### Quick-change knives

Couteaux à remplacement rapide

•

• Available / Disponible - Not available / Non disponible

Design and/or specifications are subject to change without notification.  
Enorossi se réserve le droit de modifier les caractéristiques et les spécifications techniques à tout moment et sans préavis.

## Our Range / Notre Gamme



AGRICULTURAL MACHINERY  
**enorossi**



Your Enorossi Dealer / Votre revendeur Enorossi

Via Cortonese, 36 - 06019 Calzolaro di Umbertide (PG) - ITALY  
☎ +39 075 930 22 22 - 📠 +39 075 930 23 28  
info@enorossi.it - www.enorossi.it