



CUMMINGS & BRICKER

www.cummingsandbricker.com
support@cummingsandbricker.com

Effective: 01/16/2021

F.O.B. C&B



[Click here for ordering programs-Select Program #4 from Bookmarks](#)

A & B THREE POINT HITCH ATTACHMENTS

PLOWS

ITEMNUMBER	DESCRIPTION	WEIGHT	PRICE
1BP12CT	Plow 1 Bottom 12" For Compact Cat I 15-25HP	217	\$750.00
1BP12	Plow 1 Bottom 12" 15-30HP	256	\$890.00
1BP14	Plow 1 Bottom 14" 15-30HP	256	\$896.00
1BP16	Plow 1 Bottom 16" 15-30HP	256	\$913.00
2BP12	Plow 2 Bottom 12" 25-40HP	411	\$1,558.00
2BP14	Plow 2 Bottom 14" 25-40HP	411	\$1,568.00
2BP16	Plow 2 Bottom 16" 25-40HP	411	\$1,589.00
3BP14	Plow 3 Bottom 14" 35-50HP	695	\$3,367.00
3BP16	Plow 3 Bottom 16" 35-50HP	713	\$3,474.00

PLOW OPTIONS

ITEMNUMBER	DESCRIPTION	WEIGHT	PRICE
1BPCL	Coulter For Plows (Will not fit 1BP12CT)	24	\$280.00
1BPGW	Gauge Wheel For Plows	30	\$309.00



Available with 12", 14" or 16" Bottom
 1/2" x 2 1/2" A-frame
 3 Point Hitch with Replaceable Cat 1 Lift Arm Pins
 1" x 4" Frame Members
 1" x 3" Vertical Beams
 Replaceable Shins, Shares, and Moldboards
 Shear Bolt Protection
 Grade 5 Heat Treated and Plated Fasteners
 Adjustable Width of Cut (Hill Side)
 Comes Assembled, Install A-frame and Ready & to Use
 15 - 30 HP Recommended
 Coulter or Gauge Wheel with Ball Bearings Optional

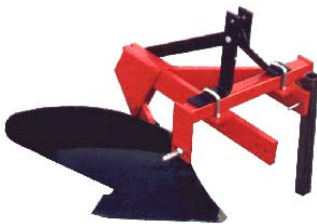



A & B THREE POINT HITCH ATTACHMENTS

DISC HARROWS

A&B offers several models of disc harrows to provide the results required by the customer. Heavier models will provide better penetration and fewer passes. For best results size the disc harrow to tractor horsepower and 3 point hitch lift capacity. C&B stocks machines with cut-out (notched) disc blades on the front gangs, and plain disc blades on rear gangs. Notched blades cut through sod and trash better than plain, and plain blades provide a more level finish. Disc harrows can be custom ordered with any combination required.

Note: Item number reflects the number of discs, diameter of the discs, and disc spacing front and rear.

Example: EH201877 EH = Eagle Harrow, 20 = number of discs, 18 = diameter of discs, 77 = 7 1/2" disc spacing front and rear.

GARDEN HARROWS

ITEMNUMBER	DESCRIPTION	WEIGHT	PRICE
GH121477	Garden Harrow 4'4" For Compact Cat I 15-25HP	258	\$1,496.00
GH121677	Disc-Garden Harrow 4'4" 15-25HP	320	\$1,589.00
GH161677	Disc-Garden Harrow 5'5" 20-25HP	360	\$1,723.00

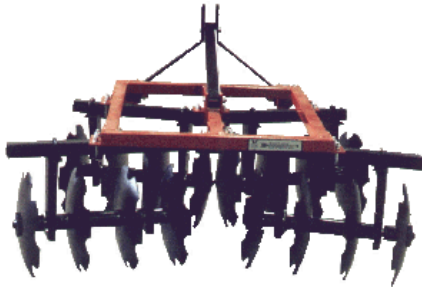

GARDEN HARROW

- HIGH STRENGTH TUBE FRAME
- 3 POINT CATEGORY I HITCH
- REINFORCED A-FRAME
- REAR STRUT IS MADE FROM HIGH STRENGTH TUBE
- TRIPLE SEALED BALL BEARINGS
- 7 1/2" SPACING FRONT AND REAR
- CUT-OUT DISC BLADES ON FRONT, PLAIN ON REAR
- COMES ASSEMBLED, INSTALL A-FRAME AND READY TO USE

EAGLE HARROWS

ITEMNUMBER	DESCRIPTION	WEIGHT	PRICE
EH161877	Disc-Eagle Harrow 5'5" 30-35HP	591	\$2,007.00
EH201877	Disc-Eagle Harrow 6'6" 35-40HP	660	\$2,085.00
EH241877	Disc-Eagle Harrow 7'7" 35-40HP	740	\$2,374.00

EAGLE HARROW

- CLEVIS AND QUICK HITCH READY
- WELDED TUBE FRAME
- SINGLE PIN ADJUSTS FRONT OR REAR GANGS
- COMES ASSEMBLED
- INSTALL A-FRAME, READY TO USE
- 1" SQUARE AXLE WITH 7 1/2" SPACING
- CAST IRON BUMPER WASHERS AND SPACERS
- TRIPLE SEALED BALL BEARINGS
- 18" DISC BLADES- CUT-OUT FRONT, PLAIN REAR





A & B THREE POINT HITCH ATTACHMENTS

DISC HARROWS

FIELD HARROWS

ITEMNUMBER	DESCRIPTION	WEIGHT	PRICE
FH181897	Disc-Field Harrow 6'6" 30-40HP	767	\$2,623.00
FH201877	Disc-Field Harrow 6'6" 30-40HP	791	\$2,516.00
FH201899	Disc-Field Harrow 6'6" 30-40HP	827	\$2,879.00
FH221897	Disc-Field Harrow 7' 40-45HP	859	\$2,846.00
FH241877	Disc-Field Harrow 7'7" 40-45HP	892	\$2,798.00

FIELD HARROW

- QUICK ATTACH READY
- WELDED TUBE FRAME
- THICK FRONT, CENTER, AND REAR STRUT TUBE
- THICK SIDE, GANG, AND REAR TUBES
- TRIPLE SEALED SELF-ALIGNING BALL BEARINGS
- SQUARE AXLES WITH UPSET HEADS
- COMBINATION DISC SPACING
- REMOVE 2 BOLTS TO ADJUST GANGS
- GRADE 5 HEAT TREATED AND PLATED FASTENERS
- WELDED 3 POINT HITCH WITH REPLACEMENT CAT. 1 LIFT ARM PINS
- COMES ASSEMBLED, INSTALL A-FRAME AND READY TO USE

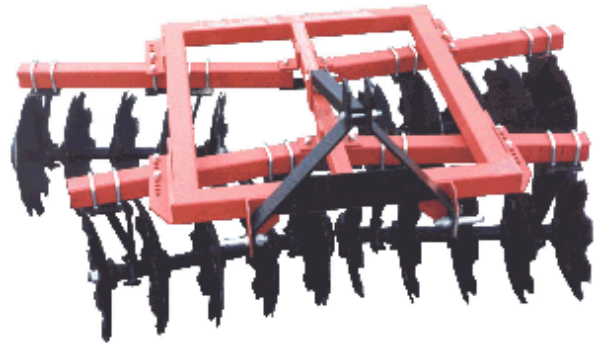

HEAVY FIELD HARROWS

ITEMNUMBER	DESCRIPTION	WEIGHT	PRICE
HFH161877	Disc-Heavy Field Harrow 5'5" 30-35HP	807	\$2,701.00
HFH161899	Disc-Heavy Field Harrow 6' 30-35HP	807	\$2,829.00
HFH181897	Disc-Heavy Field Harrow 6'6" 30-40HP	840	\$2,848.00
HFH201877	Disc-Heavy Field Harrow 6'6" 35-40HP	867	\$2,838.00
HFH201899	Disc-Heavy Field Harrow 7'4" 35-40HP	895	\$3,048.00
HFH221897	Disc-Heavy Field Harrow 7' 40-45HP	918	\$3,075.00
HFH241877	Disc-Heavy Field Harrow 7'7" 40-45HP	940	\$2,974.00



HEAVY FIELD HARROW

- WELDED TUBE FRAME
- TRIPLE SEALED BALL BEARINGS
- SQUARE AXLE WITH UPSET HEAD
- COMBINATION SPACING IS AVAILABLE
- PLAIN OR CUT- OUT DISC BLADES AVAILABLE
- SINGLE PIN ADJUSTS FRONT OR REAR GAUGES
- USES CAST IRON BUMPER WASHERS AND BLADE SPACERS
- GRADE 5 HEAT TREATED AND PLATED FASTENERS
- 3 POINT HITCH WITH REPLACEMENT CAT. 1 LIFT ARM PINS
- COMES ASSEMBLED, INSTALL A-FRAME AND READY TO USE



A & B THREE POINT HITCH ATTACHMENTS

DISC HARROWS

SCREW CRANK HARROWS

ITEMNUMBER	DESCRIPTION	WEIGHT	PRICE
SCH161899	Disc-Screw Crank Harrow 6' 30-35HP	824	\$3,237.00
SCH181897	Disc-Screw Crank Harrow 6' 30-40HP	925	\$3,243.00
SCH201877	Disc-Screw Crank Harrow 6'6" 35-40HP	878	\$3,241.00
SCH201899	Disc-Screw Crank Harrow 7'4" 35-40HP	904	\$3,450.00
SCH221897	Disc-Screw Crank Harrow 7'7" 40-45HP	925	\$3,476.00
SCH241877	Disc-Screw Crank Harrow 7'7" 40-45HP	945	\$3,386.00

SCREW CRANK HARROW

HARROW CAN BE USED AS A TANDEM HARROW
HEAVY DUTY BUSH & BOG HARROW, OR A FLEXIBLE
TANDEM HARROW

HEAVY TUBING IS USED THROUGHOUT FOR ADDED
STRENGTH

TRIPLE SEALED BALL BEARINGS

SQUARE AXLES WITH UPSET HEAD

COMBINATION SPACING AVAILABLE

PLAIN OR CUT-OUT DISC BLADES

ONE SCREW CRANK ADJUSTS FRONT OR REAR
GAUGE

3 POINT HITCH WITH REPLACEABLE CAT. 1 LIFT ARM PINS

GANGS ANGLE FROM 0 DEGREESW TO 20 DEGREES WITH ONE SCREW CRANK

COMES ASSEMBLED, INSTALL A-FRAME AND READY TO USE

GRADE 5 HEAT TREATED AND PLATED FASTENERS



CLEVIS HITCH HARROWS

ITEMNUMBER	DESCRIPTION	WEIGHT	PRICE
CHH202099	Disc-Clevis Hitch 8'2" Cat I/II 45-52HP	1217	\$5,469.00
CHH242088	Disc-Clevis Hitch 8'8" Cat I/II 45-55HP	1249	\$5,721.00
CHH242099	Disc-Clevis Hitch 9'8" Cat I/II 50-60HP	1403	\$5,855.00
CHH282088	Disc Clevis Hitch 10'0 Cat I/II 55-65HP	1372	\$6,098.00
CHH282099	Disc Clevis Hitch 11'3" Cat I/II 55-65HP	1589	\$6,224.00
CHH322088	Disc Clevis Hitch 11'4" Cat I/II 55-65HP	1496	\$6,520.00

CLEVIS HITCH HARROW

SAME SPECIFICATIONS AS THE FLEX HITCH HARROW EXCEPT WITH CLEVIS HITCH.



A & B THREE POINT HITCH ATTACHMENTS

DISC HARROWS

FLEX HITCH HARROWS

ITEMNUMBER	DESCRIPTION	WEIGHT	PRICE
FHH202099	Disc-Flex Hitch Harrow 8'2" 45-52HP	1217	\$5,469.00
FHH242088	Disc-Flex Hitch Harrow 8'8" 45-55HP	1249	\$5,721.00
FHH242099	Disc-Flex Hitch Harrow 9'8" 50-60HP	1403	\$5,855.00
FHH282088	Disc-Flex Hitch Harrow 11'3" 55-65HP	1372	\$6,098.00
FHH282099	Disc-Flex Hitch Harrow 11'3" 55-65HP	1589	\$6,224.00
FHH322088	Disc-Flex Hitch Harrow 11'4" 55-65HP	1496	\$6,520.00

FLEXIBLE HITCH HARROW

REGREASEABLE SELF-ALIGNING BALL BEARINGS AN GANGS

8 GANG BEARINGS PER HARROW

SPACING IS AVAILABLE

DISC BLADES PLAIN OR CUT-OUT AVAILABLE

SQUARE HIGH CARBON AXLES

HEAVY CAST IRON SPACERS AND BUMPER WASHERS

DOUBLE U-BOLTS ON THE REINFORCED HANGERS

FRAME IS MADE FROM HEAVY SQUARE TUBING

GANG ANGLES TO 18 DEGREES

SINGLE PIN ADJUSTS FRONT OR REAR GANGS

GRADE 5 HEAT TREATED AND PLATED FASTENERS

3 POINT HITCH WITH REPLACEABLE CAT.2 LIFT ARM PINS

COMES ASSEMBLED, INSTALL A-FRAME AND READY TO USE

SCRAPERS ARE OPTIONAL

FLEXIBLE HITCH ALLOWS HARROW TO FLOAT ON UNEVEN TERRAIN



DISC HARROW OPTIONS

ITEMNUMBER	DESCRIPTION	WEIGHT	PRICE
LTS12	Scrapers - For 12 Disc Harrows	65	\$387.00
LTS16	Scrapers - For 16 Disc Harrows	87	\$507.00
LTS18	Scrapers - For 18 Disc Harrow	98	\$572.00
LTS20	Scrapers - For 20 Disc Harrows	108	\$616.00
LTS22	Scrapers - For 22 Disc Harrows	119	\$686.00
LTS24	Scrapers - For 24 Disc Harrows	129	\$744.00
LTSINSTALL	Install And Assemble Scrapers For Disc Harrows		\$201.00
WHS20	Scraper Kit For FHH Harrows 20 Disc	112	\$983.00
WHS24	Scraper Kit For FHH Harrows 24 Disc	135	\$1,158.00
WHS28	Scraper Kit For FHH Harrows 28 Disc	157	\$1,354.00
WHS32	Scraper Kit For FHH Harrows 32 Disc	180	\$1,554.00
WHSINSTL	Install And Assemble Scrapers For FHH Disc Harrows		\$337.00



A & B THREE POINT HITCH ATTACHMENTS

DISC HARROWS

Model	GH (Compact Garden Harrow)	GH (Garden Harrow)	EH (Eagle Harrow)	FH (Field Harrow)	HFH (Heavy Field Harrow)	SCH (Screw Crank Bush & Bog)	CHH (Clevish Hitch Harrow)	FHH (Flexible Hitch Harrow)
Frame	1/8" X 2" X 2"	1/8" X 2" X 2"	3/16" x 2" x 3"	3/16" X 3" X 3" (front / center / rear strut) 1/8" X 3" X 3" (side / rear)	3/16" X 3" X 3"	3/16" X 3" X 3"	1/2 " Angle and Heavy Square Tubing	1/2 " Angle and Heavy Square Tubing
Gang Tubes	N/A	N/A	3/16" x 3" x 3"	1/8" X 3" X 3"	3/16" x 3" x 3"	3" x 3"	1/4" X 4" X 3"	1/4" X 4" X 3"
Gang Adjustment	Remove Bolts	Remove Bolts	Single Pin Adjusts Both	Remove Bolts	Single Pin Adjusts Both	Screw Crank	Single Pin Adjusts Both	Single Pin Adjusts Both
Axles	15/16" Cold Rolled	15/16" Cold Rolled	1" Square	1" Square	1" Square	1" Square	1 1/8" Square High Carbon	1 1/8" Square High Carbon
Disc Diameter (Plain or Cut-out)	14"	16"	16" or 18"	18" or 20"	18" or 20"	18" or 20"	20" or 22"	20" or 22"
Bearings	Triple Sealed Self-Aligning						Regreasable Self-aligning	
Hitch Type	Cat I Compact	Cat I	Cat I	Cat I	Cat I	Cat I	Cat I/Cat II	Cat II
Scrapers	N/A	N/A	Optional	Optional	Optional Lift Type	Optional Lift Type	Optional	Optional
Fasteners	Grade 5 Heat Treated							

Note: Item number reflects the number of discs, diameter of the discs, and disc spacing front and rear.

Example: EH201877 EH = Eagle Harrow, 20 = number of discs, 18 = diameter of discs, 77 = 7 1/2" disc spacing front and rear.

Stock units are equipped with Cut-Out (Notched) Discs on the Front, Plain Blades on the Rear.



GH For Compact Cat I

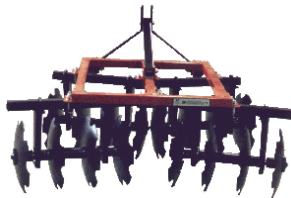

Garden Harrow For Cat I



EH Eagle Harrow

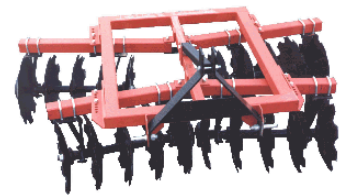

FH Field Harrow



HFH Heavy Field Harrow



SCH Screw Crank Harrow



FHH Flexible Hitch Harrow
(CHH the same except has fixed clevis hitch)



A & B THREE POINT HITCH ATTACHMENTS

AERATORS-PLUG TYPE AND SPIKE TYPE-COMBINATION 3PH OR PULL

ITEMNUMBER	DESCRIPTION	WEIGHT	PRICE
APL340	Aerator-Plug 3PH/Pull-48" (Filled Weight 517#)	349	\$2,001.00
APL350	Aerator-Plug 3PH/Pull-60" (Filled Weight 646#)	436	\$2,312.00
APL360	Aerator-Plug 3PH/Pull-72" (Filled Weight 775#)	523	\$2,720.00
AL340	Aerator-Spike 3PH/Pull-48" (Filled Weight 484#)	316	\$1,246.00
AL350	Aerator-Spike 3PH/Pull-60" (Filled Weight 605#)	395	\$1,387.00
AL360	Aerator-Spike 3PH/Pull-72" (Filled Weight 726#)	474	\$1,656.00

A&B Aerators

A&B aerators can be used as 3 point hitch or pull type. Drawbar and 3 point hitch are included with all models.

The 12" diameter drum is mounted on 1" pillow block bearings and can be filled for additional weight.

Core spoons on the plug type models are 7/8" dia. X 7 1/2" long and utilize a unique mounting system which allows them to swivel in the mount for easier penetration and release of plugs.

Spikes are 3/8" X 2" X 2 1/2" X 4" welded .



Number of core spoons or spikes:

4' models- 52

5' models- 65

6' models- 78



PASTURE RENOVATOR

3 Point Hitch with Cat 1 Lift Arm Pins
 Scarifier Shanks have Replaceable Points
 Scarifier Shanks have 3 Depth settings
 Scarifier Shanks Made from Hardened Steel
 Heavy Duty A-frame for Added Strength
 Comes Assembled Ready to use
 25-40 Recommended HP
 Reverse Shanks and Use to Move Brush
 Rakes Roots and Branches



ITEMNUMBER	DESCRIPTION	WEIGHT	PRICE
PR666	Pasture Renovator 66" Wide/6 Shank 25-40HP	180	\$762.00
PR778	Pasture Renovator 78" Wide/7 Shank 25-40HP	210	\$822.00



A & B THREE POINT HITCH ATTACHMENTS

GRADER BLADES

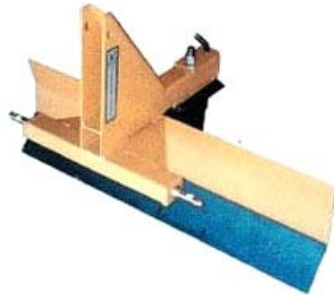

BGS40CT

- 1" Pivot Bolt
- ¼' Thick Moldboard –Double Formed
- Hitch is 3" x 3" Reinforced Tube
- Slider Style allows Blade to Offset Right or Left up to 10"
- ½" x 6" Reversible Cutting Edge
- Reinforced Blade Rotation Assembly
- Three Positions Forward and Reverse
- 3 Point hitch with Replaceable Cat I Lift Arm Pins

ITEMNUMBER	DESCRIPTION	WEIGHT	PRICE
BGS40CT	Grader Blade 48" For Compact Cat I 15-25HP	183	\$669.00
BGE40	Grader Blade 48"/Economy 15-25HP	155	\$496.00
BGE50	Grader Blade 60"/Economy 15-25HP	193	\$537.00
BGE60	Grader Blade 72"/Economy 15-25HP	232	\$591.00
BGS50	Grader Blade 60"/Slider Style 15-25HP	231	\$700.00
BGS60	Grader Blade 72"/Slider Style 25-40HP	294	\$744.00
BGS70	Grader Blade 84"/Slider Style 25-40HP	316	\$789.00
BGS80	Grader Blade 96"/Slider Style 25-40HP	338	\$857.00
BGD50	Grader Blade 60"/Slider Style W/Tilt 25-40HP	243	\$855.00
BGD60	Grader Blade 72"/Slider Style W/Tilt 25-40HP	306	\$888.00
BGD70	Grader Blade 84"/Slider Style W/Tilt 25-40HP	328	\$929.00
BGD80	Grader Blade 96"/Slider Style W/Tilt 25-40HP	350	\$997.00

CAT I GRADER BLADES

- 1 ¼" Pivot Bolt (1" on 5' models)
- ¼" thick Moldboard- Double Formed for Added Strength
- 5' Models: Hitch is 5"x3" tube Reinforced with 4"x3/8" Top and Bottom
- 6',7,&8' Models: Hitch is 6"x3" tube Reinforced with 5"x3/8" Top and Bottom
- A-frame is 3"x3/8"
- Slider Style allows Blade to Offset Right or Left up to 16"
- BGD Models have 5 Tilt Positions of 15 to 30 Degrees
- ½" x 6" Reversible Cutting Edge
- Reinforced Blade Rotation Assembly
- Five Positions Forward and Reverse
- 3 Point Hitch with Replaceable Cat I Lift Arm Pins



BGD Models – Slider Style with Tilt

BGE – ECONOMY BLADES

- Compact Hitch for Compact and Subcompact Tractors
- 3/16" Thick Moldboard-Double Formed for Extra Strength
- ½"x6" Reversible Cutting Edge
- Three Angle Positions Forward and Reverse



A & B THREE POINT HITCH ATTACHMENTS

GRADER BLADES

HYDRAULIC ANGLE GRADER BLADES

ITEMNUMBER	DESCRIPTION	WEIGHT	PRICE
BGH40	Rear Blade 48" Hydraulic Angle 20-35HP (No Hoses)	218	\$1,215.00
BGH50	Rear Blade 60" Hydraulic Angle 20-35HP (No Hoses)	232	\$1,251.00
BGH60	Rear Blade 72" Hydraulic Angle 20-35HP (No Hoses)	248	\$1,343.00
BGH70	Rear Blade 84" Hydraulic Angle 25-35HP (No Hoses)	276	\$1,438.00
BGH100	Hose Kit With Pioneer Couplers		\$241.00



ROW CROP CULTIVATOR

- All Welded Frame
- Shank Locks to keep Shanks Aligned as Set
- Each shank has 3 Mounting Positions
- 2 1/2" Reversible Points
- High Clearance
- A One row Covington or Cole Planter can be mounted
- 15-25 HP Recommended
- Grade 5 Heat Treated and Plated Fasteners
- 3 Point Hitch with Replaceable Cat I Lift Arm Pins



ITEMNUMBER	DESCRIPTION	WEIGHT	PRICE
RC650	Cultivator 1 Row	136	\$515.00

SUBSOILER

- Heavy duty 1" Wide x 6" Shank
- 1/2" x 3" Wide x 12" Reversible Point for Longer Life
- Shear Bolt Protection on Top Link
- 15" Middlebuster Shovel will fit on Footpiece
- Grade 5 Heat Treated and Plated Fasteners
- 3 Point Hitch with Replaceable Cat I Lift Arm Pins
- 20-35 HP Recommended
- Comes Assembled and Ready to Use



ITEMNUMBER	DESCRIPTION	WEIGHT	PRICE
SS003	Subsoiler - 1"X 6" Shank 20-35HP	130	\$488.00



A & B THREE POINT HITCH ATTACHMENTS

SCOOP



- 5 Cubic Foot Capacity
- 3" x 2" High Strength Rectangular Tube Frame with Angle Base
- Fabricated from 3/16" Steel
- Reversible
- Rope Controlled Dumping and Automatic Re-latching from Tractor Seat
- Reverse Position works as a Shovel
- Assembled Complete
- 3 Point Hitch with 4 Replaceable Cat I Lift Arm Pins

ITEMNUMBER	DESCRIPTION	WEIGHT	PRICE
RSO50	Scoop 5 Cubic Feet 15-25HP	216	\$746.00

UTILITY CARRIER

UCCA1:

- Angle Frame construction
- Use for Lifting Pallets and Boxes
- Replaceable Cat I Lift Arm Pins
- Add Boards and use as an All Purpose Carrier
- 25" Between angles, 38" angle length

UCCA2:

- Use for Pallets and Pallet Boxes
- Made of Heavy Wall Tubing
- Forks Shaped and Welded to Eliminate Gouging Ground
- All Welded Construction
- Replaceable Cat I Lift Arm Pins
- 25 1/2" between forks, 38" fork length



ITEMNUMBER	DESCRIPTION	WEIGHT	PRICE
UCCA1	Utility Carrier 1500# Capacity	55	\$220.00
UCCA2	Utility Carrier 3000# Capacity	95	\$424.00

WEIGHT BOX

ITEMNUMBER	DESCRIPTION	WEIGHT	PRICE
BW010	Weight Box Cat I-25"W X 15"L X 20"H	95	\$375.00



BW010 WEIGHT BOX

- CAT I
- All Welded Construction
- Quick Hitch Ready
- Attach Pins & Ready To Use
- 23" x 15" x 20"
- 103 lbs.



A & B THREE POINT HITCH ATTACHMENTS

PULVERIZERS

Model	P500SR	P600SR	P700SR
Frame	Heavy Duty 10" x 10" Wide Flange Beam	Heavy Duty 10" x 10" Wide Flange Beam	Heavy Duty 10" x 10" Wide Flange Beam
Spikes	3/4" x 8" Double Row	3/4" x 8" Double Row	3/4" x 8" Double Row
Number of Spikes	26	31	36
Number of Studs on Roller	62	68	86
Stud Size	3/8" round x 1 3/8" long	3/8" round x 1 3/8" long	3/8" round x 1 3/8" long
Roller	Spring Loaded- 6" Tube 1" Shaft w/Greasable Pillow Block Bearings	Spring Loaded- 6" Tube 1" Shaft w/Greasable Pillow Block Bearings	Spring Loaded- 6" Tube 1" Shaft w/Greasable Pillow Block Bearings
Set- up	Completely Assembled	Completely Assembled	Completely Assembled
Option	Double Roller Kit	Double Roller Kit	Double Roller Kit



ITEMNUMBER	DESCRIPTION	WEIGHT	PRICE
P500SR	Pulverizer 60" Single Roller 20-30HP	460	\$1,881.00
P600SR	Pulverizer 72" Single Roller 25-35HP	534	\$2,155.00
P700SR	Pulverizer 84" Single Roller 30-50HP	608	\$2,409.00
P500DR	60" Double Roller Conversion Kit	678	\$2,526.00
P600DR	72" Double Roller Conversion Kit	767	\$2,873.00
P700DR	84" Double Roller Conversion Kit	861	\$3,188.00

ROAD GRADER

ITEMNUMBER	DESCRIPTION	WEIGHT	PRICE
BGR50	Road Grader Blade 60" 30HP	485	\$1,370.00
BGR60	Road Grader Blade 72" 35HP	540	\$1,473.00
BGR70	Road Grader Blade 84" 40HP	594	\$1,521.00
BGR501	60" 4 Shank Road Grader-Angled Dual Edges	525	\$1,622.00
BGR601	72" 6 Shank Road Grader-Angled Dual Edges	567	\$1,710.00
BGR701	84" 6 Shank Road Grader-Angled Dual Edges	649	\$1,867.00

- Heavy End Plates
- Cutting Edges are 1/2" x 6" Abrasion Resistant Steel. Interchangeable and Reversible
- Welded A-Frame with Replaceable Cat I "C" Type Hitch Pins
- Quick hitch compatible
- Dual Cutting Edges are Angled for Constant Down Pressure Resulting in Better Cutting and Leveling
- Digging of the Dual Cutting Edges allows Grass and Debris to Flow Through Evenly
- Recycles Gravel by Turning, Mixing, Sifting and Leveling with NO Washboard Effect on Unpaved Roads





A & B THREE POINT HITCH ATTACHMENTS

LANDSCAPE RAKES

- 1" Pivot Bolt and 3' x 3" Reinforced Tube
- Reinforced Rotation Assembly
- Five Positions Forward and Reverse
- Turns 360 Degrees
- 1' x 5/16" x 27" SAE 5160 Heat Treated Spring Steel Teeth
- 3 Point Hitch with Replaceable Cat I Lift Arm Pins
- Grade 5 Heat Treated and Plated Fasteners

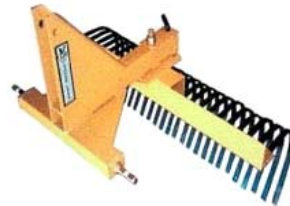

ITEMNUMBER	DESCRIPTION	WEIGHT	PRICE
RLH60	72" HD Landscape Rake Cat I 25-40HP	245	\$1,055.00
RLH70	84" HD Landscape Rake Cat I 25-40HP	276	\$1,162.00
RLH80	96" HD Landscape Rake Cat I 25-40HP	316	\$1,259.00
RLE40	Yard Rake 48"	139	\$642.00
RLE50	Yard Rake 60"	173	\$743.00
RLE60	Yard Rake 72"	208	\$840.00
RLE70	Yard Rake 84"	229	\$927.00
RLE80	Yard Rake 96"	249	\$1,005.00
RGWPR	Gauge Wheels-Pair		\$550.00

Cat I Landscape Rakes

- 1" Pivot Bolt (1 1/4" on 6', 7', & 8') and 5" x 3" Reinforced Tube
- Hitch is 6"x3" x 3/16" Tube Reinforced with 5"x3/8" Top and Bottom and 3"x 3/8" "A"-frame
- Reinforced Rotation Assembly
- Five Positions Forward and Reverse
- Turns 360 Degrees
- 1' x 5/16" x 27" SAE 5160 Heat Treated Spring Steel Teeth
- 3 Point Hitch with Replaceable Cat I Lift Arm Pins
- Grade 5 Heat Treated and Plated Fasteners (Exact fit)
- Optional Gauge Wheels



RGWPR Gauge Wheels



CUMMINGS & BRICKER

www.cummingsandbricker.com
support@cummingsandbricker.com

Effective: 01/16/2021

F.O.B. C&B



A & B THREE POINT HITCH ATTACHMENTS

BOX SCRAPERS

ITEMNUMBER	DESCRIPTION	WEIGHT	PRICE
BLEC40	Box Scraper 48" Compact Cat I 15-25HP	280	\$882.00
BLEC50	Box Scraper 60" 15-25HP	330	\$935.00
BLEC55	Box Scraper 66" 25-35HP	416	\$1,063.00
BLEC60	Box Scraper 72" 25-35HP	450	\$1,098.00
BLS60	Box Scraper Standard Duty 72" 35-50HP, CAT I & II	770	\$2,320.00
BLS65	Box Scraper Standard Duty 78" 35-50HP, CAT I & II	810	\$2,450.00
BLS70	Box Scraper Standard Duty 84" 35-50HP, CAT I & II	830	\$2,792.00
BLS80	Box Scraper Standard Duty 96" 35-50HP, CAT I & II	962	\$2,792.00
BLCW55	Box Scraper Clevis Hitch 66" 25-40HP, CAT I & II	525	\$1,329.00
BLCW60	Box Scraper Clevis Hitch 72" 25-40HP, CAT I & II	557	\$1,358.00
BLCW65	Box Scraper Clevis Hitch 78" 25-40HP, CAT I & II	597	\$1,539.00
BLCW70	Box Scraper Clevis Hitch 84" 25-40HP, CAT I & II	638	\$1,605.00
BLCW80	Box Scraper Clevis Hitch 96" 25-40HP, CAT I & II	724	\$1,797.00
KBF60	Box Scraper 72" Floating Rear Moldboard 35-50HP, CAT I & II	881	\$2,846.00
KBF65	Box Scraper 78" Floating Rear Moldboard 35-50HP, CAT I & II	926	\$3,031.00
KBF70	Box Scraper 84" Floating Rear Moldboard 35-50HP, CAT I & II	973	\$3,161.00
KBF80	Box Scraper 96" Floating Rear Moldboard 35-50HP, CAT I & II	1061	\$3,631.00
DEDUCT	For No Shanks	Deduct \$12/Shank	



A & B THREE POINT HITCH ATTACHMENTS

BOX SCRAPERS

Model	BLEC (Medium Duty)	BLS (Standard Duty)	BLCW (Clevis Hitch)	BLR (Rollover)	KBF (Floating Rear Moldboard)
End Plate Thickness	BLEC40 -3/16" BLEC50 -3/16" BLEC60 - 1/4"	3/8"	3/8"	3/8"	3/8"
Back Plate Thickness	3/16" Triple Formed	3/16" Roll Formed	1/4" Roll Formed	1/4" Double Formed Top & Bottom	Front- 3/16" Roll Formed Rear- 3/16" Double Formed
Scarifier Tube Thickness	3/16"	BLS60/65 - 5/16" BLS70/80 - 3/8"	BLCW55/60/65 - 5/16" BLCW70/80 - 3/8"	5/16"	3/8"
Scarifier Points	Replaceable	Replaceable	Replaceable	Replaceable	Replaceable
Number of Shanks	BLEC40 (3) BLEC50 (4) BLEC60 (5)	BLS60/BLS65 (7) BLS70 (8) BLS80 (9)	BLCW55/60/65 (6) BLCW70 (7) BLCW80 (8)	BLR55 (6) BLR60/65 (7) BLR70 (8)	KBF60/65 (7) KBF70 (8) KBF80 (9)
Scarifier Depth Settings	3	2	3	3	2
Cutting Edge	1/2" X 6" Reversible	1/2" X 6" Reversible	1/2" X 6" Reversible	1/2" X 6" Reversible and Interchangeable	1/2" X 6" Reversible
Hitch Type	Welded Cat I (BLEC40 Compact Cat I)	Welded Cat I & II	Welded Cat I & II Clevis Hitch	Welded Cat I & II	Welded Cat I & II
Recommended Horsepower	15-35	35-50	25-40	35-50	35-50

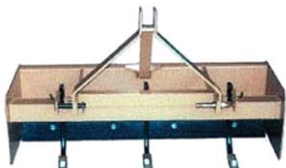

BLEC Compact CAT I



BLS Standard Duty



BLCW Clevis Hitch



BLR Rollover



KBF Floating Rear Moldboard





Hay & Straw Moisture Meter

ITEMNUMBER	DESCRIPTION	WEIGHT	PRICE
AGFH0013	10" HFM II Hand Held Moisture Tester Probe	2	\$450.00
AGFH0010	20" HFM II Hand Held Moisture Tester Probe	2	\$499.00
AGFH0011	40" HFM II Hand Held Moisture Tester Probe	2.5	\$525.00
AGFP0010	Baler Mounted Moisture Monitor Universal Mounting-With Monitor	3.5	\$679.00

HAY & STRAW MOISTURE METERS

Professional measuring instruments for determining moisture and temperature of baled hay or straw.

Handheld Moisture Meter

Easy moisture control with ongoing display of the readings during the measurement procedure for rapid moisture measurement at different locations within the bale.

- Ergonomically shaped wooden handle
- Moisture range 9 to 70%
- Temperature range 32° F to 212° F
- 13mm LCD display
- Adjustable alert function
- No calibration necessary
- Power supply with 9 V battery



Baler-Mounted Moisture Meter



For farmers and contractors who want control of their moisture content during the baling process.

- Robust construction, high quality materials
- Splashproof display
- Stainless steel mounting bracket
- Backlit LCD display with 13mm high digits
- 0.8% Accuracy
- Measuring range from 9 to 70%
- Ongoing display of the measured value
- Adjustable alert function
- No calibration necessary
- Sensor plate of high-strength plastic
- Sturdy sensor mounting with 4 screws M8

DISTRIBUTED BY:



Cummings & Bricker
Batavia, NY - Carlisle, PA
cumming sandbricker.com



www.apv-america.com

PRICE LIST

2021

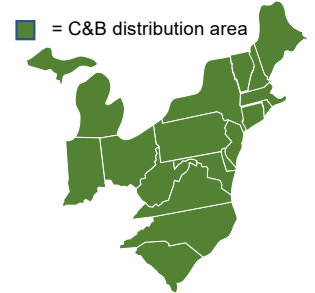

Better seeding, spreading & cultivating



Contents

Terms of Delivery & Payment.....	3	Grassland Harrow	36
Distributors.....	4	GS 300 M1 & GS 600 M1	36
Mini Spreader.....	5	Grassland Combi	37
KS 40 M2.....	5	GK 250 M1 & GK 300 M1	37
Single Disc	6	Grassland Pro Harrow	38
ES 100 M1 Special.....	6	GP 300 M1	38
ES 100 M3 Special.....	7	GP 600 M1	39
Multi-Metering System	8	Grassland Roller.....	40
MDD 40 M1 & MDD 100 M1	8	GW 250 M1 & GW 300 M1	40
MDP 40 M1 & MDP 100 M1	9	Skid Steer.....	41
Pneumatic		GW 250/ GK 250	41
Seeders PS 120 M1 / PS 200 M1 / PS 300 M1.....	10	Rotary Hoe.....	42
PS 500 M2	11	RH 600 M1	42
PS 800 M1	12	Tined Weeder	43
PS 1600 M1 (stand alone)	13	AS 600 M1 & AS 900 M1 rigid	43
PS 1200 M1 & PS 1600 M1 with Implement Carrier	14	AS 900 M1 & AS 1200 M1 scissor folding	44
Pneumatic Seeders Fertilizer Edition.....	15	Tined Weeder Pro.....	45
PS 120 M1 D & PS 200 M1 D & PS 300 M1 D	15	VS 150 M1, 300, 600, 750, 900, 1200	45
Pneumatic Seeder TWIN.....	16	Accessories for VS 150 M1 & VS 300 M1	46-47
PS 300 M1 D TWIN	16	Accessories for VS 600 M1 & VS 1200 M1	48-49
Which PS Seeder is Right for me?.....	17- 18	Snow and Ice Removal Spreaders.....	50
Pneumatic Seeders for special applications:		WD 40 M2	50
9-16 to 32 outlets.....	19	UDW 100 M1 & UDW 250 M1	51
Seeding shafts.....	20-21		
“Standard” series	20		
for Fertilizer Edition & TWIN PS	22		
for PS series for Special Applications	22		
Control Boxes	25		
Control Box 5.2	25		
Control Box 6.2	26		
Control Box 1.2	27		
Control Box 5.7	28		
ISOBUS.....	29		
Sensors & Accessories.....	30-32		
Sensors			
for PS.....	30		
Accessories for PS and MD	33-34		
Accessories for PS	35		

Terms of Delivery and Payment

With the publication of this price list, all previous price lists and price quotations lose their validity. The prices are net prices excluding sales tax. All prices are in USD and are subject to change without notice, ex factory, without packaging, without transport costs, without fees, without custom taxes and without exchange fees. Various fees and charges will be invoiced.

Terms of business and DELIVERY

We sell and cooperate exclusively according to the current version of the APV General Terms of Business and Delivery. The full text is available at <https://en.apv.at/general-terms-and-conditions>.

The weights specified include the implement, including the parts specified in the standard scope of delivery, but not the packaging.

Our technicians focus continuously on improving our implements. Therefore, we reserve the right to undertake the changes and improvements that we consider to be necessary. There is no corresponding obligation to expand this to implements already delivered. All technical data and images are not binding, we reserve the right to operate changes to the design.



NEW: Warranty ACTIVATION

From 01.01.2021 the obligatory warranty activation must be carried out for APV.

Every APV machine - from disc spreader to harrow - must be registered shortly after delivery. By registering, the right to warranty service is activated and APV can guarantee the best service. As our sales partner, you will ensure the complete recording of data and activation of the guarantee.

This enables us to meet the increasing customer demands together. The easiest and fastest way is online at <https://www.apv-america.com/service/warranty-registration/>

Warranty PROVISIONS

The warranty policies defined by APV shall apply. Warranty works are accepted only after previous agreement with our service department.

Technical specifications

For the use of all APV implements, the user must ensure compliance with the Road Traffic Act of the respective country. APV shall not be held liable for the assembly and installation of the spreaders and seeders.

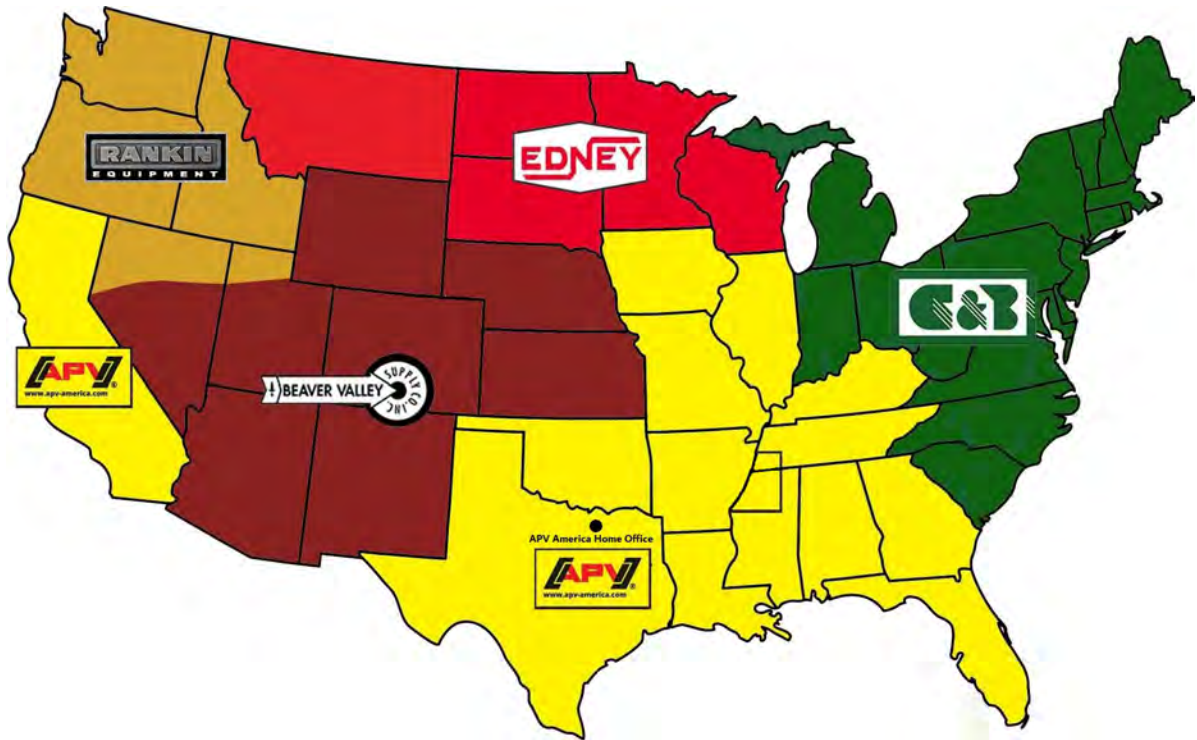

FIND OUR APV AMERICA INC. PRODUCTS THROUGH OUR CURRENT DISTRIBUTORS



Beaver Valley Supply Co.
 P.O. Box 419, Atwood, KS 67730
www.beavervalley.com
 (800) 982
 9591 Northfield Blvd
 Denver, CO 80238
 (800) 528



Cummings & Bricker, Inc.
 P.O. Box 928
 100-120 Lehigh Avenue
 Batavia, NY 14020
www.cummingsandbricker.com
 (800) 222
 100 Stover Drive
 Carlisle, PA 17015
 (717) 249



Edney Distributing Co., Inc.
 8485 215th Street West
 Lakeville, MN 55044
www.edneyco.com
 (888) 443





Rankin Equipment Co.
 P.O. Box 168
 Yakima, WA 98907
www.rankinequipment.com
 (800) 426

APV America Inc.
 370 Highport Road. Ste 101, PO BOX 2381
 Pottsboro, TX 75076 - 800-644-9481
info@apv-america.com • www.apv-america.com



www.apv-america.com

FOLLOW APV AMERICA INC. ON SOCIAL MEDIA!

-  www.facebook.com/APVAmerica
-  https://www.youtube.com/channel/UCITBGve4X_05YZiW5tXZTtQ
-  twitter.com/APVAmerica

Information is provided without guarantee; APV America Inc. is not responsible for errors and omissions. All images are representative.

Mini Spreader

KS 40 M2



Technical data

Working width 3-39 ft
 Dimensions H 2 ft x W 1.5 ft x D 2 ft
 Seed hopper 1.41 cu ft / 1.14 bu
 Net weight 41.89 lbs
 Power data 12 V / 25 A



Items included

- Electric Control Box 2.10 with steel bracket for mounting in the driver's cab
- Complete spreader with electric spreading disc and adjustable throwing vanes
- 1 deflector, agitator extension
- Top link mounting and counter plate
- 9 ft cable for power supply from the battery to the Control Box,
20 ft cable from the spreader to the Control Box

PRICING

Part No	Mini Spreader	
01001-1-001	KS 40 M2.	\$1271.00
Part No	Options & Accessories	
00300-2-107	Mounting kit towing hitch	\$398.00
00300-1-001	Truck bed mounting bracket	\$363.00
00300-2-022	Mounting kit quad bracket height-adjustable	\$389.00
00300-2-135	Bracket height-adjustable (added for consistency)	\$411.00
00410-2-190	Extension cable ES SS 16.4 ft.	\$93.00



Single Disc Spreader

ES 100 M1 CLASSIC



Technical data

Working width 6-79 ft
 Dimensions H 3 ft x W 1.8 ft x D 2 ft
 Seed hopper 3.53 cu ft / 2.84 bu
 Net weight 63.93 lbs
 Power data 12 V / 25 A



Items included

- Electric Control Box 2.10 with steel bracket for mounting in the driver's cab
- Complete spreader with electric spreading disc and adjustable throwing vanes
- Spring dowel pins for extending the agitator for grass
- 3 deflectors for fine adjustment of the lateral distribution
- Top link mounting and counter plate
- 2 ft cable for power supply from the battery to the Control Box, 20 ft cable from the spreader to the Control Box

PRICING

Part No	Single Disc Spreader	
02008-1-001	ES 100 M1 Classic	\$1845.00
Part No	Options & Accessories	
02001-1-103	Precision dispersion plate 3 1/4"-13 1/8" width	\$239.00
02000-2-004	Accessory kit calibration bag ES with scale 1.....	\$115.00
00300-2-107	Mounting kit towing hitch	\$398.00
00300-1-001	Truck bed mounting bracket ..	\$363.00
00300-2-022	Mounting kit quad bracket height-adjustable.....	\$389.00
00300-2-135	Bracket height-adjustable (added for consistency)	\$411.00
00410-2-190	Extension cable ES SS 16.4 ft.....	\$93.00
00300-1-089	Mounting kit machinery triangle.....	\$277.00

1 This calibration bag can only be used in combination with guard bar mounted on spreader



Single Disc Spreader

ES 100 M3 SPECIAL



Technical data

Working width up to 92 ft (with slug pellets "Metarex")¹
 Dimensions H 35.43 in x W 21.65 in x D 23.62 in
 Seed hopper 3.53 cu ft / 2.84 bu
 Net weight 66.14 lbs
 Power data 12 V / 25 A

¹ In order to reach a uniform distribution for a working width below 4 m, we recommend using a precision dispersion plate (see accessories)



Items included

- Electric Control Box 3.5 with steel bracket for mounting in the driver's cab
- Complete spreader with electric spreading disc and 2 throwing vanes
- Spring dowel pins for extending the agitator for grass
- Top link mounting and counter plate
- 5 ft cable for power supply from the 3-pin plug to the Control Box,
20 ft cable from the spreader to the Control Box

PRICING

Part No	Single Disc Spreader	
02012-1-001	ES 100 M3 Special	\$2,325.00
Part No	Options & Accessories	
00410-2-169	Tractor linkage upper bar sensor MX kit	\$310.00
00410-2-173	Tractor linkage lower bar sensor (accessory kit)	\$262.00
02001-1-103	Precision dispersion plate 3 1/4"-13 1/8" width	\$239.00
02000-2-004	Accessory kit calibration bag ES with scale ¹	\$115.00
00300-2-107	Mounting kit towing hitch	\$398.00
00300-1-001	Truck bed mounting bracket	\$363.00
00300-2-022	Mounting kit quad bracket height-adjustable	\$389.00
00300-2-135	Mounting kit quad bracket	\$411.00
00410-2-016	Extension cable ES MX 16.4 ft	\$150.00
00410-2-022	Power cable for tractors 26.2 ft	\$355.00
00410-2-105	Power cable 5.X NA	\$183.00
00410-2-182	Power cable 5.X (optional)	\$77.00



¹ This calibration bag can only be used in combination with guard bar mounted on spreader

Multi-Metering System

MDD 40 M1 / MDD 100 M1

with spreading disc



Technical data



Items included

Working width up to 92 ft (with slug pellets "Metarex")¹
 Max. metering quantity... up to 11 lbs/min (depending on seeds)
 Dimensions H 32.68 in x W 21.65 in x D 23.62 in (MDD 40 M1)
 H 41.34 in x W 21.65 in x D 23.62 in (MDD 100 M1)
 Seed hopper 3.5 cu ft / 2.84 bu
 Net weight 61.73 lbs (MDD 40 M1) / 66.14 lbs (MDD 100 M1)
 Power data 12 V / 25 A

- Complete spreader with hopper, metering unit, frame and spreading disc
- Point of impact adjustment
- Top link mounting and counter plate
- Calibration bag
- Seed wheel set for 2 seeding shafts (Flex, fine and fine-blind seed wheels)
- 19.69 ft cable from spreader to Control Box

1 In order to reach a uniform distribution for a working width below 4 m, we recommend using a precision dispersion plate (see accessories) or the modular implement extension to MDP

PRICING

Part No	Multi-Metering System MDS	
11001-6-023	MDD 40 M1.....	\$1,767.00
11002-6-030	MDS 100 M1.....	\$2,108.00
Part No	Required Controller (select one)	
00300-2-301	1.2 Controller (Accessory Kit).....	\$794.00
00300-2-042	5.2 Controller (Accessory Kit).....	\$1,466.00
00300-2-214	6.2 Controller (touch screen).....	\$2,554.00
Part No	Options & Accessories	
02001-1-103	Precision dispersion plate 3 1/4"-13 1/8" width.....	\$239.00
11000-2-002	Accessory kit 2 outputs (to MDP).....	\$353.00
11000-2-006	Accessory kit 6 outputs (to MDP).....	\$496.00
11000-2-007	Accessory kit electric fan (on MDP).....	\$409.00
11000-2-060	Accessory kit fill level sensor.....	\$251.00
00410-2-185	Calibration button.....	\$133.00
00410-2-148	Extension cable PS MX 6.6 ft (for sensors).....	\$166.00
00410-2-149	Extension cable 16.4 ft (for seeder).....	\$222.00
11000-2-067	Accessory kit switch MDD - MDP.....	\$181.00
00300-1-089	Mounting kit machinery triangle.....	\$277.00



- 1 Requires one of the three controllers
- 2 For use with the 1.2 & 5.2 Controller
- 3 For use with the 5.2 Controller

Multi-Metering System

MDP 40 M1 / MDP 100 M1 with fan



Technical data

Working width up to 15 ft (6 outlets)
 Dimensions H 32.68 in x W 18.50 in x D 23.62 in (MDP 40 M1)
 H 41.34 in x W 21.65 in x D 21.65 in (MDP 100 M1)
 Seed hopper.....3.5 cu ft / 2. 84 bu
 Net weight61.73 lbs (MDP 40 M1) / 66.14 lbs (MDP 100 M1)
 Power data.....12 V / 25 A



Items included

- Complete spreader with hopper, metering unit, frame & fan
- Top link mounting & counter plate
- Calibration bag
- 6 dispersion plates, 3 hexagonal bars of 4 ft & 82 ft hose
- Seed wheel set for 2 seeding shafts (Flex, fine & fine-blind seed wheels)
- 20 ft cable from spreader to Control Box

PRICING

Part No	Multi-Metering System MDP	
11002-6-005	MDP 40 M1 ¹	\$2,178.00
11002-6-005	MDP 100 M1 ¹	\$2,519.00
Part No	Required Controller (select one)	
00300-2-301	1.2 Controller (Accessory Kit)	\$794.00
00300-2-042	5.2 Controller (Accessory Kit)	\$1,466.00
00300-2-214	6.2 Controller (touch screen)	\$2,554.00
Part No	Options & Accessories	
11000-2-060	Accessory kit fill level sensor	\$251.00
00410-2-185	Calibration button	\$133.00
00410-2-148	Extension cable PS MX 6.6 ft (for sensors)	\$166.00
00410-2-149	Extension cable 16.4 ft (for seeder)	\$222.00
11000-2-067	Accessory kit switch MDD - MDP	\$181.00
11000-2-009	Accessory kit disc spreader (on MDD)	\$496.00
11000-2-002	Accessory kit 2 outputs (to MDP)	\$353.00

¹ Requires one of the three controllers



Pneumatic Seeders

PS 120 M1 / PS 200 M1 / PS 300 M1



Technical data

Working width 3 – 20 ft with electric double fan, 8 outlets
 3 – 20 ft with hydraulic fan, 8 outlets
 3 – 40 ft with hydraulic fan, 16 outlets (optional)
 (8 outlets with 8 Y-dividers (see page 59)
 or doubling pieces (see page 44)
 available as accessories)

Dimensions see page 17

Seed hopper 4.23 cu ft / 3.4 bu (PS 120)
 7.1 cu ft / 5.7 bu (PS 200)
 10.5 cu ft / 8.5 bu (PS 300)

Net weight elec./hydr... see page 17

Power data 12 V / 25 A



Items included

- Complete seeder with hoses (82.02 ft)
- Seeding shaft for fine seeds, seeding shaft for coarse seeds (for additional seed applications see seeding shafts on page 21)
- Agitator
- 19.69 ft cable from seeder to Control Box
- Calibration slide, counter plate, calibration bag, seed scale, fill level sensor
- Fan monitoring with fan speed (rpm) sensor ² for hydraulic fan
- 8 dispersion plates & 4 hexagonal bars of 3.94 ft (for mounting of the dispersion plates)

PRICING



Part No	Pneumatic Seeders	Price
04018-6-062	PS 120 M1 electric fan (w/ Controller) ¹	\$3,891.00
04001-6-102	PS 200 M1 electric fan (w/o Controller) ¹	\$4,371.00
04001-6-103	PS 200 M1 hydraulic fan (w/o Controller) ¹	\$7,595.00
04002-6-121	PS 300 M1 electric fan (w/o Controller) ¹	\$4,805.00
04002-6-218	PS 300 M1 hydraulic fan (w/o Controller) ¹	\$8,029.00
Part No	Required Controller (select one)	Price
00300-2-301	1.2 Controller (Accessory Kit)	\$794.00
00300-2-042	5.2 Controller (Accessory Kit)	\$1,466.00
00300-2-214	6.2 Controller (touch screen)	\$2,554.00
Part No	Options & Accessories	Price
00410-2-185	Calibration button ²	\$133.00
00410-2-148	Extension cable PS MX 6.6 ft (for sensors)	\$166.00
00410-2-149	Extension cable 16.4 ft (for seeder)	\$222.00
04000-2-269	Conversion kit fill level sensor	\$344.00
04000-2-114	Mounting kit upper link PS 120 M1 - PS 500 M2	\$432.00
00410-2-022	Power cable for tractors 26.2 ft ³	\$355.00
00300-2-052	Sensor set: GPSa sensor + tractor linkage lower bar sensor	\$1,541.00
00300-2-053	Sensor set: GPSa sensor + tractor linkage upper bar sensor	\$1,589.00

1 Requires a suitable Controller
 2 For use with the 1.2, 5.2 and 6.2 Controllers
 3 This cable is required for tractors without interior power receptacles

Pneumatic Seeder

PS 500 M2



Technical data

Working width 3 – 20 ft with electric double fan, 8 outlets
 3 – 20 ft with hydraulic fan, 8 outlets
 3 – 40 ft with hydraulic fan, 16 outlets (optional)
 (8 outlets with 8 Y-dividers (see page 59)
 or doubling pieces (see page 44)

Dimensions see page 17

Seed hopper 17.7 cu ft / 14.2 bu

Net weight elec./hydr.... see page 17

Power data 12 V / 25 A



Items included

- Complete seeder with hoses (82.02 ft)
- Seeding shaft for fine seeds, seeding shaft for coarse seeds (for additional seed applications see seeding shafts on page 21)
- Agitator
- 19.69 ft cable from seeder to Control Box
- Calibration slide, counter plate, calibration bag, seed scale, fill level sensor² Fan monitoring with fan speed
- (rpm) sensor² for hydraulic fan
- 8 dispersion plates & 4 hexagonal bars of 3.94 ft (for mounting of the dispersion plates)

PRICES

Part No	Pneumatic Seeders	
04003-6-102	PS 500 M2 electric fan (w/o Controller) ¹	\$6,340.00
04003-6-162	PS 500 M2 hydraulic fan (w/o Controller) ¹	\$9,564.00
Part No	Required Controller (select one)	
00300-2-301	1.2 Controller (Accessory Kit)	\$794.00
00300-2-042	5.2 Controller (Accessory Kit)	\$1,466.00
00300-2-214	6.2 Controller (touch screen)	\$2,554.00
Part No	Options & Accessories ²	
00300-2-052	Sensor set: GPSa sensor + tractor linkage lower bar sensor	\$1,541.00
00410-2-185	Calibration button ³	\$133.00
00410-2-148	Extension cable PS MX 6.6 ft (for sensors)	\$166.00
00410-2-149	Extension cable 16.4 ft (for seeder)	\$222.00
04000-2-114	Mounting kit upper link PS 120 M1 - PS 500 M2	\$432.00
00300-2-053	Sensor set: GPSa sensor + tractor linkage upper bar sensor	\$1,589.00
00410-2-022	Power cable for tractors 26.2 ft ⁴	\$355.00
04000-2-457	Conversion kit PS 120-500 16 outlets	\$803.00

¹ Optimized for use with PS 500 M2, PS 500 M2 D as well as MDS & MDP
² For additional options & accessories for PS Seeders, see page. 32
³ For use with the 5.2 and 6.2 Controller
⁴ Required for tractors without interior power receptacles



Pneumatic Seeder

PS 800 M1



Technical data

Working width 3 – 40 ft with hydraulic fan, 16 outlets
 3 – 60 ft with hydraulic fan, 32 outlets (optional)

Dimensions see page 17

Seed hopper PS 800: 28.3 cu ft / 22.7 bu

Net weight hydr see page 17

Power data 12 V / 25 A



Items included

- Complete seeder with hoses (246.06 ft)
- Seeding shaft for fine seeds, seeding shaft for coarse seeds (for additional seed applications see seeding shafts on page 21)
- Agitator
- 19.69 ft cable from seeder to Control Box
- Calibration slide, calibration bag, seed scale, fill level sensor²
- Fan monitoring with fan speed (rpm) sensor²
- 16 dispersion plates & 8 hexagonal bars of 3.94 ft (for mounting of the dispersion plates)
- Crane straps for easier handling during mounting

PRICING: PS 800 M1, PS 1200 M1 & PS 1600 M1

Part No	Pneumatic Seeders
04011-6-012	PS 800 M1 hydraulic fan (w/o Controller) ¹ \$13,888.00
Part No	Required Controller (select one)
00300-2-042	5.2 Controller (Accessory Kit). \$1,466.00
00300-2-214	6.2 Controller (touch screen). \$2,554.00
Part No	Options & Accessories ²
00410-2-148	Extension cable PS MX 6.6 ft (for sensors). \$166.00
00410-2-149	Extension cable 16.4 ft (for seeder) \$222.00
00410-2-185	Calibration button. \$133.00
04011-2-121	Conversion kit PS 800 32 outlets. \$1,683.00
00410-2-022	Power cable for tractors 26.2 ft ³ \$355.00
00300-2-052	Sensor set: GPSa sensor + tractor linkage lower bar sensor \$1,541.00
00300-2-053	Sensor set: GPSa sensor + tractor linkage upper bar sensor \$1,589.00

¹ Requires a suitable Controller

² For additional options & accessories for PS Seeders, see pgs. 32. For wider working widths, see pg. 33 for Y-splitter kits

³ This cable is required for tractors without interior power receptacles



Pneumatic Seeders

PS 1600 M1 (stand alone)



Technical data

Working width	3 – 40 ft with hydraulic fan, 16 outlets
.	3 – 60 ft with hydraulic fan, 32 outlets (optional)
.	
.	
Dimensions	see page 17
Seed hopper	56.6 cu ft / 45.5 bu
Net weight hydr	see page 17
Power data	12 V / 25 A



Items included

- Complete seeder with hoses (246.06 ft)
- Seeding shaft for fine seeds, seeding shaft for coarse seeds (for additional seed applications see seeding shafts on page 21)
- Agitator
- 19.69 ft cable from seeder to Control Box
- Calibration slide, calibration trough, seed scale, fill level sensor²
- Fan monitoring with fan speed (rpm) sensor²
- 16 dispersion plates & 8 hexagonal bars of 3.94 ft (for mounting of the dispersion plates)
- Universal bracket for mounting on soil tillage implement
- Crane straps for mounting

PRICING: PS 800 M1, PS 1200 M1 & PS 1600 M1

Part No Pneumatic Seeders

04049-6-009 PS 1600 M2 hydraulic fan (w/o Controller)¹ \$19,592.00

Part No Required Controller (select one)

00300-2-042 5.2 Controller (Accessory Kit) \$1,466.00
 00300-2-214 6.2 Controller (touch screen) \$2,554.00

Part No Options & Accessories²

00410-2-148 Extension cable PS MX 6.6 ft (for sensors) \$166.00
 00410-2-149 Extension cable 16.4 ft (for seeder) \$222.00
 00410-2-185 Calibration button \$133.00
 04048-2-007 Conversion kit PS 1200-1600 32 outlets \$1,683.00
 00410-2-022 Power cable for tractors 26.2 ft³ \$355.00
 00300-2-052 Sensor set: GPSa sensor + tractor linkage lower bar sensor \$1,541.00
 00300-2-053 Sensor set: GPSa sensor + tractor linkage upper bar sensor \$1,589.00

¹ Requires a suitable Controller

² For additional options & accessories for PS Seeders, see pgs. **32** For wider working widths, see pg. **33** for Y-splitter kits

³ This cable is required for tractors without interior power receptacles



Pneumatic Seeders with Implement Carrier

PS 800 M1 / PS 1200 M1 ¹ + MT2 M1 / PS 1600 M1 + MT2 M1



Technical data

Working width 3 – 40 ft with hydraulic fan, 16 outlets
 3 – 60 ft with hydraulic fan, 32 outlets (optional)
 (16 outlets with 16 Y-dividers (see page 58) or doubling
 pieces (see page 44) available as accessories)

Dimensions see page 17

Seed hopper PS 800: 28.3 cu ft / 22.7 bu
 PS 1200: 42.3 cu ft / 34.0 bu
 PS 1600: 56.5 cu ft / 45.4 bu

Net weight hydr ... see page 17

Power data 12 V / 25 A



Items included

- Complete seeder with hoses (246.06 ft)
- Seeding shaft for fine seeds, seeding shaft for coarse seeds (for additional seed applications see seeding shafts on page 21)
- Agitator
- 19.69 ft cable from seeder to Control Box
- Calibration slide, calibration trough, seed scale, fill level sensor³ Fan monitoring with fan speed (rpm) sensor³
- 16 dispersion plates & 8 hexagonal bars of 3.94 ft (for mounting the dispersion plate)
- Platform

PRICING

Part No	Pneumatic Seeders with Quick Hitch	
09002-6-013	MT2 (Quick hitch).	\$4,060.00
09002-6-015	PS 800 M1 hydraulic fan + MT2 NA (Quick Hitch). . .	\$17,948.00
04050-6-028	PS 1200 M1 hydraulic fan + MT2 NA (Quick Hitch) + Cat 3 .	\$23,613.00
04050-6-012	PS 1600 M2 hydraulic fan + MT2 NA (Quick Hitch) + Cat 3 .	\$25,621.00
Part No	Required Controller (select one)	
00300-2-042	5.2 Controller (Accessory Kit).	\$1,466.00
00300-2-214	6.2 Controller (touch screen).	\$2,554.00
Part No	Options & Accessories ¹	
09001-2-003	Accessory kit drawbar eye	\$1,331.00
09002-2-012	Accessory kit drawbar hitch.	\$1,460.00
09002-2-038	Accessory kit hose extension.	\$1,097.00
00410-2-185	Calibration button.	\$133.00
00410-2-148	Extension cable PS MX 6.6 ft (for sensors).	\$166.00
00410-2-149	Extension cable 16.4 ft (for seeder)	\$222.00
00300-2-053	Sensor set: GPSa sensor + tractor linkage upper bar sensor	\$1,589.00
00410-2-022	Power cable for tractors 26.2 ft ²	\$355.00



¹ For additional options & accessories for PS Seeders, see pgs. 32. For wider working widths, see pg. 33 for Y-splitter kit
² This cable is required for tractors without interior power receptacles

Pneumatic Seeders Fertilizer Edition

PS 120 M1 D / PS 200 M1 D / PS 300 M1 D / PS 500 M1 D / PS 800 M1 D



Technical data

Working width	3 – 20 ft with electric double fan, 8 outlets
.....	3 – 20 ft with hydraulic fan, 8 outlets
.....	3 – 40 ft with hydraulic fan, 16 outlets (optional) (8 outlets with 8 Y-dividers (see page 59) or doubling pieces (see page 44) available as accessories)
Dimensions	see page 17
Seed hopper	PS 120: .23 cu ft / 3.4 bu
Net weight elec. / hydr	see page 17
Power data	12 V / 25 A



Items included

- Complete non-corrosive seeder with hoses (82.02 ft)
- Seeding shaft for fine seeds (fine seed stores, micro granules, etc.) and seeding shaft Flex20 for coarse seeds (fertiliser, cereals, etc.)(see page 21)
- Agitator made of stainless steel
- 19.69 ft cable from seeder to Control Box
- Non-corrosive calibration slide, calibration bag, counter plate (galvanized), seed scale
- Fan monitoring with fan speed (rpm) sensor ² for hydraulic fan 8 stainless steel dispersion plates & 4 galvanized hexagonal bars of 3.94 ft (for mounting of the dispersion plates)

PRICING

Part No	Pneumatic Seeders Fertilizer Edition	
04031-6-021	PS 120 M1 D electric fan (w/o Controller) ¹	\$5,534.00
04032-6-020	PS 200 M1 D electric fan (w/o Controller) ¹	\$6,014.00
04032-6-036	PS 200 M1 D hydraulic fan (w/o Controller) ¹	\$9,238.00
04033-6-021	PS 300 M1 D electric fan (w/o Controller) ¹	\$6,448.00
04033-6-056	PS 300 M1 D hydraulic fan (w/o Controller) ¹	\$9,672.00
04032-6-036	PS 500 M1 D hydraulic fan (w/o Controller) ¹	\$8,114.00
04032-6-036	PS 500 M1 D hydraulic fan (w/o Controller) ¹	\$11,338.00
04033-6-056	PS 800 M1 D hydraulic fan (w/o Controller) ¹	\$16,058.00

Part No	Required Controller (select one)	
00300-2-301	1.2 Controller (Accessory Kit)	\$794.00
00300-2-042	5.2 Controller (Accessory Kit)	\$1,466.00
00300-2-214	6.2 Controller (touch screen)	\$2,554.00

Part No	Options & Accessories ²	
04000-2-269	Conversion kit fill level sensor	\$344.00
00410-2-148	Extension cable PS MX 6.6 ft (for sensors)	\$166.00
00410-2-149	Extension cable 16.4 ft (for seeder)	\$222.00
04000-2-114	Mounting kit upper link PS 120 M1 - PS 500 M2	\$432.00
00410-2-185	Calibration button	\$133.00
04000-2-534	Conversion kit PS 300-500 Fertilizer 16 outlets	\$614.00
00300-2-053	Sensor set: GPSa sensor + tractor linkage upper bar sensor	\$1,589.00
00410-2-022	Power cable for tractors 26.2 ft	\$355.00



1 Requires a suitable controller
 2 For additional options & accessories for PS Seeders, see pgs. 32. For wider working widths, see pg. 33 for Y-splitter kits.
 3 This cable is required for tractors without interior power receptacle

Pneumatic Seeders TWIN

PS 300 M1 D TWIN

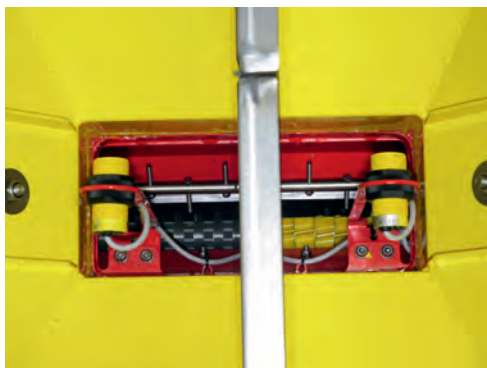

Technical data

Working width	10 ft with 4 outlets per seeding shaft
.	(8 outlets with 8 Y-dividers (see page 58) or doubling pieces (see page 44)
.	available as accessories)
Dimensions	see page 17
Seed hopper	10.5 cu ft / 8.5 bu
Net weight elec. / hydr.	see page 25
Power data	12 V / max. 40 A



Items included

- Complete non-corrosive seeder with hoses (82.02 ft)
- Seeding shaft f-fb for fine seeds and Flex20 for coarse seeds (see page 21)
- 19.69 ft cable from seeder to Control Box
- Calibration slide, counter plate (galvanized)
- 8 stainless steel dispersion plates & 4 galvanized hexagonal bars of 3.94 ft (for mounting of the dispersion plates)
- 2 x calibration bag, seed scale
- Fan monitoring with fan speed (rpm) sensor² for hydraulic fan
- 2 x fill level sensors (1 x per hopper half)

Item no.	Pneumatic Seeder TWIN		
04042-6-010	PS 300 M1 D TWIN electric fan 1	USD	8,083.00
04042-6-024	PS 300 M1 D TWIN hydraulic fan 1	USD	10,780.00

You require a suitable Control Box:

Item no.	Control Box		
00300-2-151 . .	Control Box 5.7 (Accessory kit)	USD	1,860.00

Item no.	Accessories		
00410-2-185	Calibration button	USD	133.00
04000-2-114	Mounting kit top link PS 120 M1 - PS 500 M2.	USD	432.00
00410-2-065	Power supply AP (26.25 ft long) (power supply cable for additional towing vehicle)	USD	197.00

Which is the right Pneumatic Seeder for me?

Overview APV PS series:

AVAILABLE PS SERIES PNEUMATIC SEEDERS

- **Standard Series:** PS 120 M1, PS 200 M1, PS 300 M1, PS 500 M2 (see pages 12 - 14)
PS 800 M1, PS 1200 M1 & PS 1600 M1 (see pages 15-16)
- **D Series Fertilizer Editions:** PS 120 M1 D, PS 200 M1 D, PS 300 M1 D, PS 500 M2 D & PS 800 M1 D (see page 17)
- **With MT2 Quick Hitch:** PS 800 M1 + MT2, PS 1200 + MT2 & PS 1600 + MT2 (see page 18)

SELECTION CONSIDERATIONS

- **What do you want to spread?** APV America Inc.'s PS Series seeders are ideal for a variety of applications. For wider working widths or larger/heavier seeds, consider a PS Series product with a hydraulic fan.
- **A hydraulic fan requires** one (1) single acting valve and one (1) low-pressure (65 psi max) return, or return to a case drain. **The maximum required pressure is 2,600 psi and maximum required oil volume is 10 gpm.**

FAN TYPE

Calculate the spread rate per minute. Use this rate to determine whether you need a pneumatic seeder with an electric fan or hydraulic fan.



Attention! For heavy seeds (beans, peas, wheat, granular micro nutrients), a hydraulic fan should **ALWAYS** be selected!

$\frac{\text{Seed quantity (lbs / acre)} \times \text{speed (mph)} \times \text{working width (ft)}}{495} = \text{lbs/min}$			
Maximum lbs/minute	0 - 7.7 lbs/min	0 - 30.9 lbs/min	0 - 66.1 lbs/min
Suitable seeder	PS 300 – 500 with electric fan	PS 300 – 500 with hydraulic fan	PS 800 – 1600 with hydraulic fan

Application Example:

Mr. Johnson would like to apply 30 lbs radish seed/acre at a speed of 10 mph, the pneumatic seeder is mounted on a 20 ft cultivator.

Calculation

$$\frac{30 \text{ lbs / acre} \times 10 \text{ mph} \times 20 \text{ ft}}{495} = 12.12 \text{ lbs/min}$$

With this result, Mr. Johnson would be directed to buy a either a PS 300 or a PS 500 with a hydraulic fan. The PS will be mounted at the front on the cultivator's draw bar and the longest tubing will be 23 ft long. Tubing length is also a consideration; in this case, due to a longer tube length, the PS unit with the hydraulic fan is again the best choice.

Which is the right Pneumatic Seeder for me?

Overview APV PS series:

TUBING LENGTH

Good seeding results are dependent on the tubing length and efficient routing of the tubes. **Connect the longest tubes nearest the drive motor and the shortest tubes opposite the drive motor.**

Maximum Tubing Length	13.1 ft	26.2 ft		32.8 ft	45.9 ft
Maximum Working Width	19.7 ft	23.0 ft	39.4 ft	39.4 ft	39.4 ft–78.7 ft
Suitable Seeder	PS 300 – 500 electric fan	PS 300 – 500 w/hydraulic fan	PS 300 – 500 hydr. fan with Y divider kit	PS 800 – 1600 w/hydraulic fan	PS 800 – 1600 w/special equipment ¹

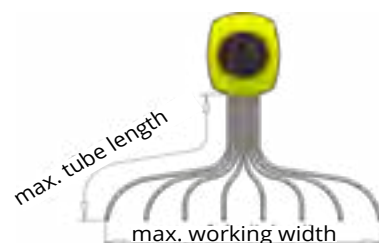

¹ Please contact your sales consultant.

SELECTION OF THE CORRECT HOPPER SIZE

Pneumatic Seeder with electric / hydraulic fan	Dimensions in inches Height x Width x Depth	Weight	Hopper Capacity Cubic ft / Bushels
PS 120 + electric fan	35.5 in H x 23.6 in W x 31.5 in D	99.3 lbs	4.23 cu ft / 3.4 bu
PS 200 + electric fan	39.4 in H x 27.6 in W x 35.5 in D	132.4 lbs	71 cu ft / 5.7 bu
PS 200 + hydraulic fan	39.4 in H x 27.6 in W x 43.3 in D	182.2 lbs	72 cu ft / 5.7 bu
PS 300 + electric fan	43.3 in H x 31.5 in W x 39.4 in D	154 lbs	10.5 cu ft / 8.5 bu
PS 300 + hydraulic fan	43.3 in H x 31.5 in W x 45.3 in D	205 lbs	10.5 cu ft / 8.5 bu
PS 500 + electric fan	49.2 in H x 31.5 in W x 49.2 in D	205 lbs	17.7 cu ft / 14.2 bu
PS 500 + hydraulic fan	49.2 in H x 31.5 in W x 49.2 in D	256 lbs	17.7 cu ft / 14.2 bu
PS 800 + hydraulic fan	49.2 in H x 39.4 in W x 67.0 in D	551 lbs	28.3 cu ft / 22.7 bu
PS 1200 + hydraulic fan	65.0 in H x 43.3 in W x 88.6 in D	1,037 lbs	42.3 cu ft / 34 bu
PS 1600 + hydraulic fan	70.9 in H x 43.3 in W x 88.6 in D	1,102 lbs	56.6 cu ft / 45.5 bu
PS 800 + hydraulic fan with MT2	77.1 in H x 69.1 in W x 66.9 in D	1,213 lbs	28.3 cu ft / 22.7 bu
PS 1200 + hydraulic fan with MT2	80.7 in H x 86.6 in W x 59.1 in D	2,359 lbs	42.3 cu ft / 34 bu
PS 1600 + hydraulic fan with MT2	88.6 in H x 86.6 in W x 59.1 in D	2,425 lbs	56.5 cu ft / 45.4 bu

OPTIMUM POSITIONING OF THE PS SEEDER

Determine the optimum position of the PS seeder on the tillage implement with the following criteria:

- Short, downward sloping tubing
- Mounting position and mounting height of the dispersion plates (7" – 15" above ground, max. 30" from one deflector plate center to the next with elec. fans, and 34" for hydr. fans)
- Safe filling, calibration and metering roll replacement
- Adequate space for the seed hopper on folding implements
- Is the wiring harness long enough? (harness length 19.7 ft)
- Are the 19.7 ft hydraulic hoses long enough?

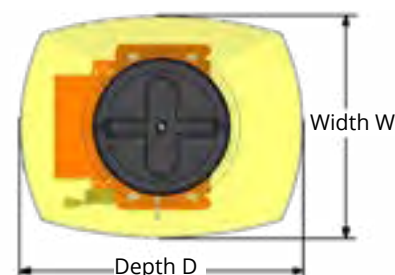

Doubling of outlets (to 9-16 or 32 outlets)

Special applications: 9 - 16 or 32 outlets



Ideal for

- Row-dependent seeding on 9 - 16 outlets for PS 120 M1 - PS 500 M2
- Row-dependent seeding of 2 different seeds on 8 outlets each for PS 300 M1 D TWIN
- Row-dependent seeding on 32 outlets for PS 800 M1 - PS 1600 M1
- Ideal for PS 200 M1 - PS 500 M2 with hydraulic fan with a working width of 23 – 39 ft for grass seeds, clover and other small seeds in low quantities (instead of Y-dividers)
- Ideal for PS 300 M1 D TWIN for a working width of up to 23 ft with 2 different seeds (grass seeds, clover and other small seeds in low quantities)

Not suitable for

- Large and heavy seeds (e.g. beans, peas, etc.)

Choice of fan

Calculate the spread rate per minute and find out based on the result whether you require a Pneumatic Seeder with electric or hydraulic fan.

$$\frac{\text{Seed quantity (lbs / acre) x speed (mph) x working width (ft)}}{495} = \text{lbs / min}$$

max. lbs / minute:	0 to 5.8 lbs / min	<ul style="list-style-type: none"> • 0 to 16.7 lbs / min for grass • 0 to 30.14 lbs / min for mustard, clover 	<ul style="list-style-type: none"> • 0 to 30.14 lbs / min for grass • 0 to 66.2 lbs / min for mustard, clover
suitable seeder:	PS 120 – PS 500 with electric fan	PS 200 – PS 500 with hydraulic fan	PS 800 - PS 1600 with hydraulic fan

Choice of the right hose length

max. hose length	13.12 ft	26.25 ft	32.81 ft
suitable seeder	PS 120 - 500 with electric fan	PS 200 - 500 with hydraulic fan	PS 800 - PS 1600 with hydraulic fan

Conversion kits for special applications

The conversion kits can ONLY be ordered when purchasing a Pneumatic Seeder "Standard" or "Fertilizer Edition".

The assembly takes place directly in the APV factory and cannot be retrofitted later!

Doubling of outlets

16 (PS 120-500) or 32 (PS 800-1600) outlets

Extra charge			
Configuration	Extra charge PS 120-500 16 outlets	USD	2,706.00
on request	Extra charge PS 800 32 outlets	USD	2,871.00
	Extra charge PS 1200-1600 32 outlets	USD	2,953.00



Extended scope of DELIVERY of your PS

- Transition elements (1 on 2 outlets)
- Seeding shafts (fb-f and Flex20) (instead of standard seeding shafts)
- Sealing lip, clamping plate
- Additionally 8 pieces (PS 120-500) or 16 pieces (PS 800-1600) dispersion plates
- Additionally 1 roll of hose (82.02 ft) (PS 120-500) or 3 rolls of hose (246.06 ft) (PS 800 - 1600)

Individual number of outlets

9-16 (PS 120-500) outlets

To configure the Pneumatic Seeder "PS configured" please contact your APV consultant. We are happy to answer your special requests!

Choices included with the configurable PS are:

- Which hopper size is required for the Pneumatic Seeder?
- Number of outlets
- With or without hose
- With or without dispersion plates
- With or without hexagonal bars or counter plate
- Which seeding shafts?

Seeding shafts for Pneumatic Seeders PS "Standard" series

Standard equipment



The fine-blind: fb-f-fb-fb



The coarse: G-G-G

PS Fertilizer Edition

Standard equipment



The fine-blind: fb-f-fb-fb
specially protected against corrosion



The Flex 20: fb-Flex20-fb
specially protected against corrosion

Seeding shafts for Standard PS series

Here you can find an overview of our seeding shafts for the "Standard" PS series. For seed mixtures we recommend the Flex seeding shafts.

These seeding shafts are not suitable for the Pneumatic Seeders of the Fertilizer Edition.



Seeding shafts for the Fertilizer Edition are available on page 48.



PS "Standard" Series

Standard equipment

		
	The fine-blind (fb-f-fb-fb)	The coarse (G-G-G)
	Mustard, phacelia	Grass
PS 120 to PS 500	Item no: 04001-2-127 Price: USD 140.00	Item no: 04001-2-110 Price: USD 135.00
PS 800 to PS 1600	Item no: 04000-2-121 Price: USD 225.00	Item no: 04000-2-120 Price: USD 222.00

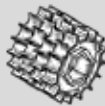
Accessories (optional)

				
	The fine-full (fb-fv-fv-fb)	The extrafine (fb-fb-ef-eb-fb)	The extrafine-full (fb-efv-efv-fb)	The fine (f-f-f-f)
	Clover, cress	Poppy	Canola	Grass, mustard, cress
PS 120 to PS 500	Item no: 04000-2-062 Price: USD 171.00	Item no: 04001-2-129 Price: USD 270.00	Item no: 04000-2-005 Price: USD 253.00	Item no: 04001-2-130 Price: USD 140.00
PS 800 to PS 1600	Item no: 04000-2-063 Price: USD 288.00	Item no: 04000-2-133 Price: USD 476.00	Item no: 04000-2-007 Price: USD 431.00	Item no: 04000-2-142 Price: USD 225.00



				
	The coarse-blind (GB-G-GB)	The Flex 10 (fb-Flex10-fb-fb)	The Flex 20 (fb-Flex20-fb)	The Flex 40 (Flex40)
	Buckwheat, fodder radish	Buckwheat, vetch	Seed mixtures, cereals, peas, beans, lupine, vetch	
PS 120 to PS 500	Item no: 04001-2-131 Price: USD 135.00	Item no: 04000-2-718 Price: USD 251.00	Item no: 04000-2-138 Price: USD 239.00	Item no: 04000-2-137 Price: USD 253.00
PS 800 to PS 1600	Item no: 04000-2-141 Price: USD 222.00	Item no: 04000-2-841 Price: USD 450.00	Item no: 04000-2-140 Price: USD 428.00	Item no: 04000-2-139 Price: USD 462.00

Seeding shafts for Fertilizer Edition & TWIN-PS

These seeding shafts are specially protected against corrosion.

PS Fertilizer Edition

Standard equipment

		
	The fine-blind (fb-f-fb-fb)	The Flex 20 (fb-Flex20-fb)
	Micro granules fertilizer, mustard, phacelia	Fertilizer, peas, beans, vetch
PS 120 to PS 500	Item no: 04000-2-064 Price: USD 171.00	Item no: 04000-2-086 Price: USD 251.00
PS 800	Item no: 04054-2-039 Price: USD 254.00	Item no: 04054-2-041 Price: USD 442.00

Accessories (optional)

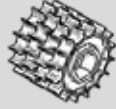

	
	The fine (f-f-f-f)
	Gras, mustard, cress
PS 120 to PS 500	Item no: 04000-2-184 Price: USD 171.00
PS 800	Item no: 04054-2-051 Price: USD 254.00

Accessories (optional)

				
	The fine-full (fb-fv-fv-fb)	Die Extrafeinvolle (fb-efv-efv-fb)	The Flex 10 (fb-Flex10-fb-fb)	The Flex 40 (Flex40)
	Micro granules fertilizer, clover, cress	Canola	Micro granules fertilizer, buckwheat, vetch	Fertilizer, cereals, peas, beans, vetch
PS 120 to PS 500	Item no: 04000-2-074 Price: USD 183.00	Item no: 04000-2-170 Price: USD 287.00	Item no: 04000-2-718 Price: USD 251.00	Item no: 04000-2-087 Price: USD 307.00
PS 800	Item no: 04054-2-049 Price: USD 301.00	Item no: 04054-2-050 Price: USD 462.00	Item no: 04000-2-841 Price: USD 450.00	Item no: 04054-2-052 Price: USD 515.00

TWIN

Standard equipment

		
	The fine-blind (fb-f)	The Flex 20 (Flex20)
	Mustard, clover, phacelia	Cereals, fertilizer, buckwheat, vetch
PS 300 M1 D TWIN	Item no: 04043-2-016 Price: USD 261.00	Item no: 04043-2-014 Price: USD 354.00

Accessories (optional)

	
	The fine (f-f)
	Grass, cereals, cress
PS 300 M1 D TWIN	Item no: 04043-2-015 Price: USD 261.00



Seeding shafts for PS special applications

PS series for special applications 16 or 32 outlets

Standard equipment

		
	The fine-blind (fb-f)	The Flex 20 (Flex20)
	Mustard, clover, phacelia	Cereals, fertilizer, buckwheat, vetch
PS 120 to PS 500	Item no: 04000-2-176 Price: USD 184.00	Item no: 04000-2-162 Price: USD 375.00
PS 800 to PS 1600	Item no: 04000-2-524 Price: USD 339.00	Item no: 04000-2-525 Price: USD 623.00

Accessories (optional)

			
	The fine (f-f)	The fine-blind - fine-full (fb-fv)	The fine-full (fv-fv)
	Grass, cereals, cress	Canola, mustard, phacelia	Mustard, phacelia
PS 120 to PS 500	Item no: 04000-2-161 Price: USD 145.00	Item no: 04000-2-175 Price: USD 174.00	Item no: 04000-2-163 Price: USD 166.00
PS 800 to PS 1600	Item no: 04000-2-528 Price: USD 267.00	Item no: 04000-2-527 Price: USD 280.00	Item no: 04000-2-529 Price: USD 338.00

			
	The fine-blind - extrafine-full (fb-efv)	The extrafine-full (efv-efv)	The Flex 10 (Flex10)
	Canola		Micro granules fertilizer, buckwheat, vetch
PS 120 to PS 500	Item no: 04000-2-177 Price: USD 291.00	Item no: 04000-2-178 Price: USD 428.00	Item no: 04000-2-842 Price: USD 395.00
PS 800 to PS 1600	Item no: 04000-2-526 Price: USD 609.00	Item no: 04000-2-530 Price: USD 888.00	Item no: 04000-2-840 Price: USD 729.00

Control Boxes

Control Box 5.2

The Control Box 5.2 is the most popular version of the APV Control Boxes and includes extensive functions. Such functions as adjusting the spread rate to the travel speed, the automatic switch-off on headland, the ability to precisely regulate the electric fan or the automatic execution of the calibration test simplify work enormously.



User benefits

- Electronic control and monitoring of the seeding shaft
- Electronic adjustment of the spread rate during operation
- Emptying
- Speed calibration
- Automatic adjustment of spread rate to travel speed (in combination with the speed sensor²)
- Pre-metering
- Adjustment of electric fan and spreading plate (for MDD and UDW)
- Automatic calibration test (only weighing)
- Calibration test: Display possible in lbs/ha, grains/ft² and g/ft²
- Display of operation voltage and power consumption
- Total hours and daily hours counter
- Total hectares and daily hectares counter
- Headland management (in combination with tractor linkage sensor²)
- Speed indicator and monitoring for hydraulic fan



Additional functions

- Various languages available
- Choice between various measurement units (metric, imperial or chin. mu)
- Implement monitoring (in combination with implement sensors. Example: fill level sensor)

Item no.	Control Box 5.2		
00300-2-042	Control Box 5.2 with accessory kit.....	USD	1,466.00

1 Optimized for use with PS 120 - 1600 M1, PS 120 - 800 M1 D of the Fertilizer Edition and MDD, MDP, MDG, MDC as well as UDW and LF 600M1.

2 The speed sensors & accessories are available on page 29.



Control Box 6.2

The Control Box 6.2 convinces with even more functionality for the professional farmer and contractor. The large touch display shows all key machine processes at one glance. The menu is designed for intuitive operation with self-explanatory symbols. Due to the additional functions, such as for example the automatic pre-seeding of the seeds and the creation of a seed library, you are able to configure the use of your seeder even more efficiently.



User benefits

All functions of the Control Box

5.2 in addition:

- Seedlibrary: Store your regular seeds and switch the application by pressing a button (without a new calibration test)
- Remaining quantity indicator (surface & itinerary)
- Storage of up to 5 speed calibration values for regular use of different tractors
- Speed indicator and monitoring for hydraulic fan
- Automatic pre-metering



Additional functions

- Operation via the large touch color display
- Update option via USB flashdrive and Internet
- Robust aluminum case

Item no.	Control Box 6.2		
00300-2-214	Control Box 6.2 with accessory kit.....	USD	2,554.00



- 1 Optimized for use with PS 120 - 1600 M1 and PS 120 - 800 M1 D of the Fertilizer Edition
- 2 The speed sensors & accessories are available on page 29.

Control Box 1.2

The Control Box 1.2 is the ideal starter module and is characterized by its compactness. It controls the fundamental seeding functions and is compatible with selected implement sensors. Adjustment of the speed of the seeding shaft and fan is easy, quick and straightforward.



User benefits

- Electronic control and monitoring of the seeding shaft
- Electronic control and monitoring of electric fan and the spreading disc (for MDD and UDW)
- Electronic adjustment of the spread rate during operation
- Calibration test
- Acoustic and visual error warning
- Emptying



Additional functions

- Implement monitoring (in combination with implement sensors. Example: fan monitor)
- Possibility of fill level alert (in combination with implement sensors. Example: fill level sensor)

Item no.	Control Box 1.2		
00300-2-201	Control Box 1.2 with accessory kit	USD	794.00

1 Optimized for use with PS 120 M1 - PS 500 M2, PS 120 M1 - 500 M2 D of the Fertilizer Edition as well as MDD, MDP, MDG, MDC and UDW.



Control Box 5.7

The Control Box 5.7 completes the PS 300 M1 D TWIN and enables a separate control of two seeding shafts. With the same type of functioning, the Control Box 5.7 also offers the possibility to operate up to two APV seeders in parallel and independently of each other with an additional adapter cable. In order to complete the package of the multitasking Control Box, the control is compatible and can be combined with any sensors.



User benefits

All functions of the Control Box

5.2 in addition:

- Independent control of up to two seeding shafts and an electric fan (PS 300 M1 D TWIN)
- Parallel operation of up to two APV seeders independently of each other
- No limitation on the use of additional implement sensors



User's instructions

When jointly using two Pneumatic Seeders with electric fan or two Multi-Metering Systems MDP, pay attention to a possible reduction of the ventilation system performance due to the greater power consumption.

Item no.	Control Box 5.7		
00300-2-151	Control Box 5.7 with accessory kit	USD	1,860.00
00410-2-164	Adapter PS 2 MX MCP (for the control of 2 seeders).....	USD	366.00



- 1 Optimized for use with PS 300 M1 D TWIN. Individual or parallel use of PS 120 M1 - PS 1600 M1, PS 120 M1 - 800 M1 D of the Fertilizer Edition as well as MDD, MDP, MDG and MDC.
- 2 Except fan speed (rpm) sensor

ISOBUS

All APV Pneumatic Seeders can be controlled by the ISOBUS function via the tractor's own terminal. This requires that an ISOBUS connection is available on the tractor. ISOBUS compatibility enables farmers to operate Pneumatic Seeders even more professionally. Additional functions, such as Section Control (if supported by the terminal), enable even more efficient use of APV Pneumatic Seeders.



User benefits



All functions of the Control Box 6.2

in addition:

- No additional monitor in the cabin better overview
- Only one cable from the spreader to the tractor (ISOBUS cable) - no extra cables required
- Section Control: Automatic seeding shaft switch- off depending on the GPS position
- Individual naming of seeds in the seed library
- Speed and linkage signal can be picked up directly from the ISOBUS ¹ or from various APV sensors (wheel, GPS, radar sensor)
- Compatible with various terminal versions/tractor brands - Ask your APV sales representative/distributor!



Additional functions

- Can be retrofitted to PS from 2015 onwards
- Fitted ex works for new units
- Update option depending on the terminal used

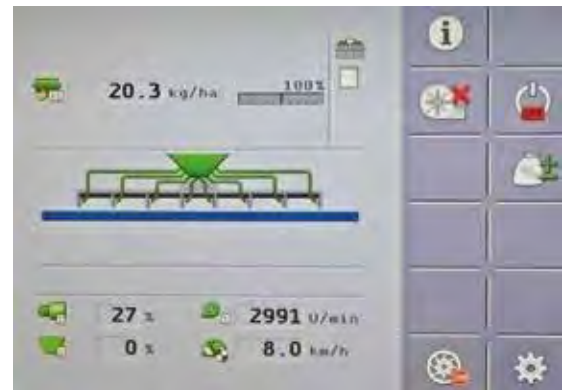

Item no.	ISOBUS		
00300-2-231	Accessory kit ISOBUS PS 120-500.....	USD	2,706.00
00300-2-232	Accessory kit ISOBUS PS 800	USD	2,871.00
00300-2-248	Accessory kit ISOBUS PS 1600	USD	2,953.00

Monitor is **not included!**

1 Depending on the equipment of the tractor
 2 Minimum requirements for terminal given



Sensors with Control Box 5.2, 6.2 & 5.7

These accessory elements can only be used with the Control Boxes 5.2, 6.2 and 5.7.

GPSa sensor (Accessory kit)

The GPSa sensor transmits the current vehicles speed to the Control Box. The current speed is measured through a combination of a GPS and a 3D acceleration sensor. Attention: The sensor does not work in the case of full GPS shadowing. Cable length: 16.40 ft



Item no.	GPSa sensor		
00410-2-180	Sensor GPSa (Accessory kit)	USD	1,279.00
00300-2-053	Sensor set: GPSa sensor + upper bar sensor	USD	1,589.00
00300-2-052	Sensor set: GPSa sensor + lower bar sensor	USD	1,541.00
00300-2-095	Sensor set: GPSa sensor + linkage sensor pull switch	USD	1,606.00
00300-2-344	Sensor set: GPSa sensor + linkage sensor hydraulic	USD	1,244.00

Radar sensor MX 35 (Accessory kit)

The radar sensor transmits the vehicle driving speed to the Control Box. The Control Box automatically regulates the rotation speed of the seeding shaft and thus the spread rate. Cable length: 16.40 ft



Item no.	Radar sensor MX 35		
00410-2-179	Radar sensor MX 35 (Accessory kit)	USD	1,434.00
00300-2-007	Sensor set: radar sensor + upper bar sensor	USD	1,744.00
00300-2-006	Sensor set: radar sensor + lower bar sensor	USD	1,696.00
00300-2-096	Sensor set: radar sensor + linkage sensor pull switch ^{1,3}	USD	1,761.00
00300-2-345	Sensor set: radar sensor + linkage sensor hydraulic ¹	USD	1,366.00

Wheel sensor (Accessory kit)

The wheel sensor measures the driving speed. The sensor is fixed onto the frame and is able to recognize both the included magnets and the screw heads, wheel studs, etc. on the wheel rim. Mounting examples: Spike wheel for seeders, depth control wheels, tractor wheels. Cable length: 16.40 ft



Item no.	Wheel sensor		
00410-2-181	Wheel sensor (Accessory kit)	USD	318.00
00202-2-553	Sensor set: wheel sensor + upper bar sensor	USD	628.00
00202-2-062	Sensor set: wheel sensor + lower bar sensor	USD	580.00
00300-2-097	Sensor set: wheel sensor + linkage sensor pull switch ^{1,3}	USD	645.00
00300-2-346	Sensor set: wheel sensor + linkage sensor hydraulic ¹	USD	489.00

1 Includes splitter cable for combined use.
 2 For tractors without tractor linkage signal
 3 Not suitable for Snow and Ice Removal Spreader UDW (see page 88).

7-pin signal cable

In case of proper tractor cabling of the signal plug, the driving speed and the tractor linkage signal are recorded and displayed on the Control Box. Cable length: 1.5 m

The signal plug must be designed and equipped tractor-sided according to the norm.



Item no.	7-pin signal cable		
00410-2-155	7-pin signal cable	USD	208.00
00202-3-552	Sensor set: signal cable + upper bar sensor ^{1,2}	USD	518.00
00202-3-497	Sensor set: signal cable + lower bar sensor ^{1,2}	USD	470.00
00300-2-098	Sensor set: signal cable + linkage sensor pull switch ^{1,2,3}	USD	535.00
00300-2-347	Sensor set: signal cable+linkagesensor hydraulic ^{1,2}	USD	403.00

Linkage sensor top link (Accessory kit)

Optimally suited for 3-point mounted implements.

For mounting on a second top link hole. Function: Mechanical operation of a spring rod. The seeding shaft is automatically released or stopped (invertible).

Cable length: 4 m



Item no.	Linkage sensor top link		
00410-2-169	Upper bar sensor (Accessory kit)	USD	310.00

Linkage sensor chassis (Accessory kit)

For mounting on movable parts in headland. Function: Contactless through a magnet.

The seeding shaft is automatically released or stopped (invertible). Cable length: 16.40 ft



Item no.	Linkage sensor chassis		
00410-2-173	Lower Bar sensor (Accessory kit)	USD	262.00

Linkage sensor pull switch (Accessory kit)

For mounting on 3-point or on moving parts in headland. Function:

Pull operation through a spring. The seeding shaft is automatically released or stopped (invertible). Cable length: 16.40 ft



Item no.	Linkage sensor pull switch		
00410-2-174	Linkage sensor pull switch (Accessory kit) ³	USD	327.00

1 Includes splitter cable for combined use.

2 For tractors without tractor linkage signal

3 Not suitable for Snow and Ice Removal Spreader UDW (see page 50-51).

Linkage sensor hydraulic (Accessory kit)

The sensor can be integrated into an implement on an existing hydraulic system (e.g.: lower bar cylinder). Function: Operation through change of pressure in the hydraulic system. The seeding shaft is automatically released or stopped. The switching pressure can be set between 20 to 50 bar. Cable length: 16.40 ft



Item no.	Linkage sensor hydraulic		
00410-2-176	Linkage sensor hydraulic (Accessory kit).....	USD	0.00

Linkage sensor INDUCTIVE (Accessory kit)

For mounting on movable parts in headland. Function: Contactless, suitable for metal. The seeding shaft is automatically released or stopped (invertible). Cable length: 39.37 ft



Item no.	Linkage sensor inductive		
00410-2-085	Linkage sensor inductive (Accessory kit).....	USD	457.00

Extension cable for sensors MX

If the cable length of the sensor is not sufficient, it can be extended with it. Cable length: 6 or 16.40 ft



Item no.	Extension cable for sensors MX		
00410-2-151	Extension cable for sensors MX 6.6 ft	USD	211.00
00410-2-152	Extension cable for seeders MX 16.40 ft	USD	268.00
00410-2-148	Extension cable PS MX 6.6 ft (for sensors)	USD	166.00
00410-2-149	Extension cable MX 16.4 ft (for seeders)	USD	222.00

Splitter cable

For combined use of speed sensor and tractor linkage sensor! Cable length: 3.28 ft



Item no.	Splitter cable		
00410-2-153	Splitter cable	USD	226.00

Accessories for PS and MD

These accessories are intended for implements of the "Standard" series, the Fertilizer Edition and the TWIN PS as well as for the MD series.

Calibration button

The calibration button hugely simplifies the calibration test and can be fixed almost anywhere on the implement due to the integrated magnets. The hopper discharge of the implement can also be performed via the calibration button. Cable length: 3.28 ft



Item no.	Calibration button ¹		
00410-2-185	Calibration button ¹	USD	133.00

Fill LEVEL sensor for PS or MD

The fill level sensor triggers an alarm on the Control Box if there is too little seed in the hopper. Cable length: 6.56 ft



Item no.	Fill level sensor ² for PS		
04000-2-269	Conversion kit fill level sensor ²	USD	344.00

Item no.	Fill level sensor ² for MD		
11000-2-060	Accessory kit fill level sensor ²	USD	251.00

Mounting and platform kit UNIVERSAL for Disc Spreaders, Multi-Metering Systems and Pneumatic Seeders

This bracket is mounted on the rearmost crossbar of the soil tillage implement so the spreader can be assembled. The mounting kit includes a platform with steps and a bracket whose angle can be adjusted for the mounting of the Disc Spreader, Multi- Metering System or Pneumatic Seeder PS120-500 (with electric or hydraulic fan).



Item no.	Mounting and platform kit universal		
04000-2-684	Mounting and platform kit universal.	USD	1,539.00

Platform kit modular

This kit enables you to retrofit a platform including a step on your soil tillage implement in order to easily get to your seeder.



Item no.	Platform kit modular		
04000-1-010	Basic platform kit modular	USD	777.00
04000-1-011	Extension platform kit modular ³	USD	659.00

1 For use with Control Box 5.2 & 6.2 & 5.7
 2 For use with Control Box 1.2 & 5.2 & 6.2 & 5.7
 3 If a step exists, any number of extensions is possible

Y-DIVIDER smooth

Y-dividers are available in two kit versions. The P8 Y-divider mounting kit includes 1 roll hose (82.02 ft), 8 dispersion plates, 4 hexagonal bars for the dispersion plate assembly, as well as 8 Y-dividers. The P16 Y-divider mounting kit includes 3 rolls hose (246.06 ft), 16 dispersion plates, 8 hexagonal bars for the dispersion plate assembly, as well as 16 Y-dividers.



Item no.	Y-divider		
00300-2-212	Mounting kit P8 Y-divider smooth	USD	603.00
00300-2-213	Mounting kit P16 Y-divider smooth	USD	1,276.00
00300-2-200	Y-divider smooth (per item)	USD	25.00

Air separator Air Guard

The cyclone shape achieves optimal air separation of seeds. This ensures optimal seed placement.



Item no.	Air separator kit Air Guard		
00600-2-092	Air separator kit Air Guard (per item)	USD	135.00
04000-2-557	Set air separator kit Air Guard with adapter tube	USD	128.00

Subsequent installation of 3-pin standard plug on tractor

The 26.25 ft cable is screwed directly with the battery poles and a 3-pin standard plug is mounted at the other end, which can be installed permanently in the tractor.



Item no.	Subsequent installation of 3-pin standard plug on tractor ¹		
00410-2-022	Power cable for tractors 26.25 ft	USD	355.00
00410-2-182	Power cable 5.X	USD	77.00

You require

Accessory kit for MD or PS on 2nd soil tillage implement

The accessory kit contains the key parts for mounting the PS 120 - 500 on a second soil tillage implement. This means that these parts do not need to be dismantled and assembled. This kit includes 1 roll of hose 82.02 ft, 8 stainless steel dispersion plates, hinge bolt clamps, 4 hexagonal edging shafts 3.94 ft, 1 counter plate and 8 cable ties.



Item no.	Accessory kit for MD or PS on 2 nd soil tillage implement		
11000-2-121	Accessory kit for MDP on 2 nd soil tillage implement	USD	504.00
04000-2-310	Accessory kit for PS on 2 nd soil tillage implement	USD	820.00

Control Box bracket

The Control Box bracket can be mounted on an already existing Müller bracket (pipe).



Item no.	Control Box bracket		
00300-2-164	Mounting kit universal Control Box bracket.	USD	28.00

¹ Not suitable for TWIN - PS.

Special accessories for PS

These accessories are intended for implements of the "Standard" series, the Fertilizer Edition and the TWIN PS.

CONVERSION electric to hydraulic fan

Necessary when the performance of the electric fan is not sufficient.



Item no.	Conversion kit electric to hydraulic fan		
08001-2-101	Conversion kit HG 300 for PS 120 M1 - PS 500 M2	USD	3,856.00

CONVERSION PTO fan ¹

Necessary when the performance of the electric fan is not sufficient and a hydraulic fan cannot be used because of less hydraulic power.



Item no.	Conversion kit PTO fan ¹		
04000-1-006	Conversion kit PTO fan	USD	2,719.00
00600-2-001	Articulated shaft BG2 24.0157 in, with freewheel	USD	358.00

Hose coupler

For easy switching the PS between several soil tillage implements. The separation process can be done without tools.

Recommended combination: Accessory kit for PS on 2nd soil tillage implement (04000-2-310).



Item no.	Hose coupler		
00300-2-215	Mounting kit hose coupler (per item)	USD	50.00
00300-2-216	Additional module for hose coupler (for additional soil tillage implement) (per item)	USD	31.00

1 Only suitable for PS 120 - 500.

Grassland Harrow

GS 300 M1 / GS 600 M1



Technical data

GS 300 M1

GS 600 M1

Working width	9.84 ft	19.69 ft
Transport dimensions (with seeder) HxWxD	6.76 ft x 9.84 ft x 5.91 ft	6.76 ft x 9.84 ft x 5.91 ft
Transport dimensions (without seeder) HxWxD	4.17 ft x 9.84 ft x 5.91 ft	4.17 ft x 9.84 ft x 5.91 ft
Transport dimensions (folded) HxWxD	-	9.78 ft x 9.84 ft x 6.50 ft
Tine spacing	3 in (3/8 in tines) 2 in (5/16 in tines)	3 in (3/8 in tines) 2 in (5/16 in tines)
Number of tines	40 pcs. (3/8 in tines) 60 pcs. (5/16 in tines)	80 pcs. (3/8 in tines) 120 pcs. (5/16 in tines)
Weight Full Edition	1,168.45 lbs	2,314.85 lbs
Feeler wheels (16.0/6,5-8" tires)	2 pcs.	4 pcs.
Mounting category	CAT 2 / CAT 2N	CAT 2
Tractor performance	from 27 HP	from 70 HP

A double-acting control unit for folding is required. (GS 600 M1)

Full Edition = GS incl. lighting, spring-mounted leveling plate, platform kit, mounting kit, PS 200 M1 (GS 300 M1) or PS 300 M1 (GS 600 M1) with electric fan incl. Control Box 5.2 and sensor set: wheel sensor + linkage sensor top link

PRICING



Items included

- Complete implement with 2 frontal rows of cranked 3/8 in tines
- 2 rear rows of cranked 5/16 in tines
- 3 pcs. parking supports (GS 600 M1)

1 compatible with PS 120 M1 - PS 300 M1 can be used with Pneumatic Seeders with electric fan PS 120 M1, PS 200 M1 and PS 300 M1. For the "Full Edition" equipment see technical data below.

Part No

07001-6-024	GS 300 M1 (with 3/8" tines) ¹	\$5,937.00
07001-6-025	GS 300 M1 (with 1/2" tines) ¹	\$6,285.00
07001-6-049	GS 600 M1 (with 3/8" tines) ¹	\$13,113.00
07001-6-050	GS 600 M1 (with 1/2" tines) ¹	\$13,803.00

Part No

00300-2-042	5.2 Controller (Accessory Kit)	\$1,466.00
00300-2-214	6.2 Controller (touch screen)	\$2,554.00

Part No

07001-2-022	Spring-mounted levelling plate (approx. 221lbs)	\$1,841.00
07000-2-060	Warning signs + lights GS (approx. 11 lbs)	\$612.00
00602-3-659	Operating hours counter	\$557.00
07000-2-008	Mounting kit for PS 120 - PS 300 on GS 300 M1	\$606.00
07000-2-030	Sensor set: wheel sensor + tractor linkage upper bar GS	\$628.00
07000-2-019	Access platform for GS (approx. 22 lbs)	\$677.00
07007-1-001	Front mounting bracket GS 300 M1	\$4,492.00
07000-2-061	Warning signs + lights GS front mounting	\$969.00
07007-2-001	Access platform for GP 300 M1 front mounting bracket	\$550.00

Grassland Harrows

Required Controller (select one)

Options & Accessories

Grassland Combi

GK 250 M1 / GK 300 M1



Technical data

GK 250 M1

GK 300 M1



Items included

Working width	7.87 ft	9.84 ft
Transport dimensions (with seeder) HxWxD	6.89 ft x 8.01 ft x 6.50 ft	6.89 ft x 9.84 ft x 6.50 ft
Transport dimensions (without seeder) HxWxD	4.30 ft x 8.01 ft x 5.97 ft	4.30 ft x 9.84 ft x 5.97 ft
Tine spacing	3 in (3/8 in tines)	3 in (3/8 in tines)
Number of tines	33 pcs.	41 pcs.
Weight (Cambridge roller 15.4 in) (Full Edition with PS 200 M1)	2,182.58 lbs	2,447.13 lbs
Weight (Cambridge roller 20.8 in) (Full Edition with PS 200 M1)	2,557.36 lbs	2,976.24 lbs
Weight (Toothed ring roller 16 in) (Full Edition with PS 200 M1)	2,777.82 lbs	3,196.70 lbs
Mounting category	CAT 2	CAT 2
Tractor performance	75 HP	90 HP

A double-acting control unit for folding is required

- Complete implement with 2 harrow rows & roller
- Two harrow rows with cranked 1/2 in tines optionally also with 3/8 in tines
- Spring-mounted leveling plate
- Grassland Cambridge roller (15.4 in or 20.9 in) or toothed ring roller (16.1 in)
- Hydraulic roller cylinder
- Parking supports on harrow and roller
- Tooltray integrated into the roller & harrow frame

PRICING

1 compatible with PS 120 M1, PS 300 M1 & MDP 100 M1

Part No

06009-6-024
06009-6-025
06009-6-026
06012-6-054
06012-6-055
06012-6-056

Grassland Combination Harrows

GK 250 w/15.4" Cambridge 1 \$12,997.00
GK 250 w/20.9" Cambridge 1 \$13,904.00
GK 250 w/16.1" toothed-ring 1 \$14,500.00
GK 300 w/15.4" Cambridge 1 \$14,144.00
GK 300 w/20.9" Cambridge 1 \$14,888.00
GK 300 w/16.1" toothed-ring 1 \$15,686.00

Part No

00300-2-042
00300-2-214

Required Controller (select one)

5.2 Controller (Accessory Kit) \$1,466.00
6.2 Controller (touch screen) \$2,554.00

Part No

00602-3-659
06008-2-021
06008-2-014
00300-2-053
06001-2-021
06008-2-025
06011-2-000
06008-2-009
06008-2-032

Options & Accessories

Operating hours counter \$557.00
Accessories front mounting meadow harrow \$1,823.00
Mounted bracket kit for MDP \$727.00
Sensor set: GPSa sensor + tractor linkage upper bar sensor \$1,589.00
Warning signs + lights \$738.00
Mounted dispersion plates GW 250 \$220.00
Mounted dispersion plates GW 300 \$243.00
Mounted access platform for GW \$653.00
Mounted bracket kit for PS \$657.00

Grassland Pro Harrow

GP 300 M1



Technical data



Items included

Working width	9.84 ft
Transport dimensions (with seeder)	H 7.55 ft x W 9.84 ft x D 7.74 ft
Transport dimensions (without seeder)	H 4.20 ft x W 9.84 ft x D 7.74 ft
Tine spacing	3 in (5/16 in tines) / 2 in (5/32 in tines)
Number of tines.....	40 pcs. (5/16) / 56 pcs. (5/32 in tines)
Weight (Cambridge roller 15.4 in) Full Edition.....	2,987.26 lbs
Weight (Cambridge roller 20.8 in) Full Edition.....	3,670.70 lbs
Weight (Toothed ring roller 16 in) Full Edition.....	3,891.16 lbs
Mounting category	CAT 2 (mast height CAT 3)
Tractor performance.....	from 100 HP

A double-acting control unit for roller adjustment is required

- Complete implement with 2 harrow sections & roller Spring-mounted leveling
- plate Heavy grassland Cambridge roller (15.4 in or 20.8 in) or toothed ring roller (16.1 in)
- Tooltray integrated into the frame

Full Edition = GP 300 M1 (with Cambridge or toothed ring roller) incl. lighting, platform kit, PS 300 M1 with electric fan incl. Control Box 5.2 and sensor set: GPSa sensor + linkage sensor top link

PRICING

Part No	Grassland Pro Harrows	
06001-6-018	GP 300 w/ 15.4" Cambridge ¹	\$18,972.00
06001-6-019	GP 300 w/ 20.8" Cambridge ¹	\$20,460.00
06001-6-020	GP 300 w/ 16.1" toothed-ring ¹	\$21,282.00
Part No Required Controller (select one)		
00300-2-042	5.2 Controller (Accessory Kit)	\$1,466.00
00300-2-214	6.2 Controller (touch screen).	\$2,554.00
Part No Options & Accessories		
06001-2-063	Warning signs + lights GP 300 M1 (approx. 11 lbs)	\$715.00
00602-3-659	Operating hours counter	\$557.00
00300-2-053	Sensor set: GPSa sensor + tractor linkage upper bar sensor	\$1,589.00
06000-2-012	Accessory kit dispersion plate assembly GP 300	\$144.00
06000-2-034	Access platform for GP 300 M1 (approx. 100 lbs)	\$1,116.00
06004-2-115	Accessory kit toolbox	\$494.00



¹ compatible with PS 300 M1 - PS 500 M1

Grassland Pro Harrow

GP 600 M1



Technical data



Items included

Working width	19.69 ft
Transport dimensions (folded).....	H 11.75 ft x W 9.84 ft x D 18.96 ft
Tine spacing	3 in (5/16 in tines) / 2 in (5/32 in tines)
Number of tines.....	78 pcs. (5/16 in tines) / 114 pcs. (5/32 in tines)
Net weight (Cambridge roller 20.8 in)	8,818.49 lbs
Net weight (Toothed ring roller 16 in)	9,259.42 lbs
Tyres	2 pcs. (400/60-15.5")
Mounting category	CAT 3N
Tractor performance.....	from 140 HP

Three double-acting control units for running gear folding and roller adjustment are required. A single-acting control unit with a pressure-less return flow is required, when configured with a Pneumatic Seeder.

- Complete implement with 3 harrow sections and roller
- Spring-mounted levelling plate
- Heavy grassland Cambridge roller (20.8 in) or toothed ring roller (16.1 in)
- 15.53 mph version

Item no. Grassland Pro Harrow

06004-1-004	GP 600 M1 (Cambridge roller 20.8 in)	USD	53,382.00
06007-1-001	GP 600 M1 (Toothed ring roller 16.1 in)	USD	55,839.00

Item no. Accessories

06000-2-728	Pneumatic brake (available only through order with implement)	USD	2,367.00
06004-2-061	Warning signs + lighting GP 600 M1	USD	564.00
06004-2-078	Mounting kit for PS 120 M1 - PS 500 M2.	USD	1,680.00
06004-2-126	Sensor set: GPSa sensor + linkage sensor chassis GP	USD	1,598.00
06004-2-036	Platform kit for GP 600 M1	USD	2,606.00
06004-2-088	24.85 mph version with MOT ¹	USD	3,719.00
06004-2-107	Accessory kit 500/50-17" tires	USD	1,998.00
06004-2-115	Accessory kit tool box	USD	494.00

Can be used ONLY with Pneumatic Seeders with HYDRAULIC fan PS 200 M1, PS 300 M1 and PS 500 M2: see page 10

Grassland Roller

GW 250 M1 / GW 300 M1



Technical data

GW 250 M1

GW 300 M1



Items included

Working width	7.87 ft	9.84 ft
Transport dimensions (with seeder) HxWxD	6.10 ft x 8.01 ft x 3.12 ft	6.10 ft x 9.84 ft x 3.12 ft
Transport dimensions (without seeder) HxWxD....	3.64 ft x 8.01 ft x 2.46 ft	3.64 ft x 9.84 ft x 2.46 ft
Net weight (Cambridge roller 15.4 in)	1,053.81 lbs ¹	1,243.41 lbs ¹
Net weight (Cambridge roller 20.8 in)	1,410.96 lbs ¹	1,746.06 lbs ¹
Net weight (Toothed ring roller 16 in)	1,666.69 lbs ¹	2,006.21 lbs ¹
Mounting category	CAT 2	CAT 2
Tractor performance.....	45 HP (heavily depends on the hoisting capacity)	50 HP (heavily depends on the hoisting capacity)

1 Corresponds to the implement net weight; approx. 330.69 lbs should be added for the entire seeder

- Complete implement with grassland Cambridge roller (15.4 in or 20.8 in) or toothed ring roller (16.1 in)
- Parking supports
- Tooltray integrated into the frame

Item no.	Grassland Roller		
06014-6-010 GW 250 M1 (Cambridge roller 15.4 in)	USD	5,208.00
06014-6-011 GW 250 M1 (Cambridge roller 20.8 in)	USD	6,107.00
06014-6-008 GW 250 M1 (Toothed ring roller 16.1 in)	USD	6,704.00
06017-6-017 GW 300 M1 (Cambridge roller 15.4 in)	USD	6,185.00
06017-6-018 GW 300 M1 (Cambridge roller 20.8 in)	USD	6,929.00
06017-6-019 GW 300 M1 (Toothed ring roller 16.1 in)	USD	7,727.00

Item no.	Accessories		
06001-2-021 Warning signs + lighting GW	USD	738.00
06008-2-025 Mounted dispersion plate installation GW 250 M1	USD	220.00
06011-2-000 Mounted dispersion plate installation GW 300 M1	USD	243.00
00300-2-053 Sensor set: GPSa sensor + linkage sensor top link	USD	1,589.00
06008-2-009 Platform kit for GW	USD	653.00
06008-2-032 Mounting kit PS for GW	USD	657.00
06008-2-014 Mounting kit MD for GW	USD	727.00

Can be used with Pneumatic Seeders with electric / hydraulic fan PS 120 M1, PS 200 M1 and PS 300 M1: see page 10 and with Multi-Metering System MDP 100 M1: see page 9.

GW 250 / GK 250 Skid Steer Attachment Seeder

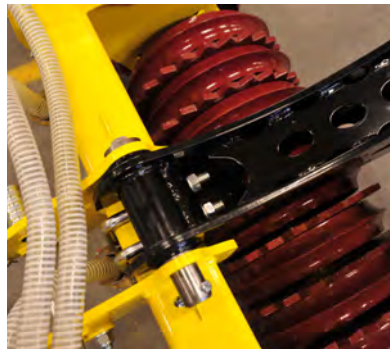

Technical data

	GW 250	GK 250 ²
✓ Working Width	8.2 ft	8.2 ft
Weight	15.4" Cambridge	1,428.6 lbs ¹
	20.8" Cambridge	1,815.8 lbs ¹
	16" toothed-ring	2,041.2 lbs ¹
⚙ Mounting Category	CAT 2 (mast height CAT 3)	
⚙ Skid Steer Performance	sufficient hydraulic lift for roller	
1 Add 331 lbs for PS 300 seeder assembly and mount; additional weight for seed/product		
2 Roller adjustment requires one (1) double-acting hydraulic remote		



PRICING

Part No	Skid Steer Kit	
06008-2-066	Skidsteer Universal quick attach kit for GK and GW . .	\$3,500.00
06008-2-032	Mounting kit for GW	\$657.00
06008-2-021	Front linkage and wheels kit for GK	\$1,823.00

This Skid Steer Kit is IN ADDITION to the regular GK and GW products. Can also be used with PS120-PS500



Rotary Hoe

RH 600 M1

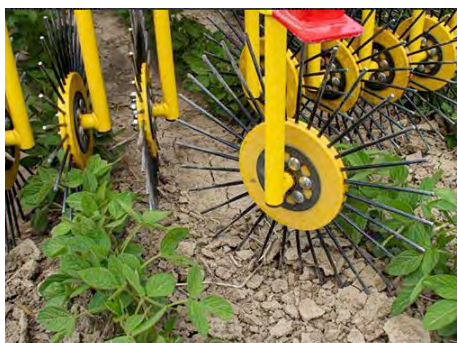

Technical data

Working width	19.69 ft
Transport dimensions (folded).....	H 9.02 ft x W 9.35 ft x D 5.09 ft
Net weight	1,543.24 lbs
Mounting category	CAT 2
Ring spacing / row spacing.....	5.9 in
Ring diameter	19.7 in
Number of hoe rings	40 pcs. with each 30 spring steel pins
Feeler wheels (16.0/6,5-8" tires)	2 pcs.
Tractor performance.....	65 HP
Inclination angle of 0-30° in 5° degree increments adjustable via quick connection A double-acting control unit for folding is required	



Items included

- Complete implement with 40 hoe rings
- Parking supports
- Grab handles on all feeler wheels for height adjustment



Item no.	Rotary Hoe		
07013-6-017	RH 600 M1	USD	24,777.00
Item no.	Accessories		
07013-2-183	Accessory kit 2 nd pair of feeler wheels.....	USD	550.00
07013-2-179	Warning signs + lighting RH for PS platform	USD	860.00
07013-2-180	Warning signs + lighting for RH 600 M1	USD	860.00
07000-2-019	Platform kit for RH 600 M1	USD	677.00
07013-2-181	Accessory kit dispersion plate installation	USD	741.00
07013-2-182	Mounting kit for PS 120 M1 - PS 300 M1 on RH 600 M1	USD	1,708.00

Can be used with Pneumatic Seeders with electric / hydraulic fan PS 120 M1, PS 200 M1 and PS 300 M1: see page 10.



Tined Weeder

AS 600 M1 / AS 900 M1 rigid



Technical data



Items included

	AS 600 M1	AS 900 M1
Working width	19.69 ft	29.53 ft
Transport dimensions (folded) HxWxD.	10.17 ft x 9.84 ft x 7.22 ft	12.47 ft x 9.84 ft x 7.22 ft
Net weight	1,477.10 lbs	2,094.39 lbs
Tine length.	17.7 in	17.7 in
Tine diameter	0.27 in	0.27 in
Tine spacing.	1.2 in	1.2 in
Number of tines	192 pcs.	288 pcs.
Number of tines per section	48 tines	48 tines
Mounting category	CAT 2 or CAT 3N	CAT 2 or CAT 3N
Feeler wheels (18,5x8-8" tires)	2 pcs.	4 pcs.
Tractor performance	60 HP	70 HP

A double-acting control unit for folding is required

- Complete implement with 4.92 ft wide harrow sections
- Parking supports
- Grab handles on all feeler wheels for height adjustment

Item no.	Tined Weeder ¹		
07017-6-026	AS 600 M1 ¹	USD	8,685.00
07016-6-011	AS 900 M1 ¹	USD	13,778.00
Item no.	Tined Weeder Top Seller		
07017-6-004	AS 600 M1 incl. hydraulic tine adjustment and warning signs + lighting	USD	3,850.00
07016-6-003	AS 900 M1 incl. hydraulic tine adjustment and warning signs + lighting	USD	5,312.00

Can be used with Pneumatic Seeders with electric / hydraulic fan PS 120 M1, PS 200 M1, PS 300 M1 and PS 500 M2: see page 10. ¹ Transport instruction: The Tined Weeder is delivered partially assembled on a pallet.



Tined Weeder

AS 900 M1 / AS 1200 M1 scissor folding

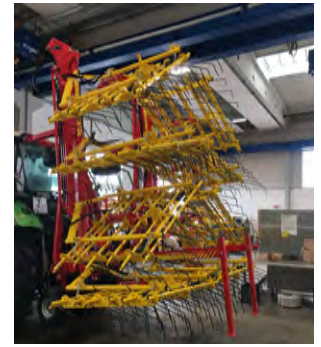

Technical data

AS 900 M1 scissor folding

AS 1200 M1 scissor folding



Items included

Working width	29.53 ft	39.37 ft
Transport dimensions (folded) HxWxD	11.65 ft x 9.84 ft x 7.87 ft	11.65 ft x 9.84 ft x 7.87 ft
Net weight	2,535.32 lbs	2,866.01 lbs
Tine length	17.7 in	17.7 in
Tine diameter	0.27 in	0.27 in
Tine spacing	1.2 in	1.2 in
Number of tines	288 pcs.	384 pcs.
Number of tines per section	48 tines	48 tines
Mounting category	CAT 2 or CAT 3N	CAT 2 or CAT 3N
Feeler wheels (18,5x8-8" tires)	4 pcs.	4 pcs.
Tractor performance	80 HP	90 HP

- Complete implement with 4.92 ft wide harrow sections
- Parking supports
- Grab handles on all feeler wheels for height adjustment

A double-acting control unit for folding is required

Item no.	Tined Weeder ¹		
07021-6-021	AS 900 M1 scissor folding	USD	16,729.00
07015-6-030	AS 1200 M1 scissor folding	USD	19,722.00
Item no.	Tined Weeder Top Seller		
07021-6-010	AS 900 M1 scissor folding incl. hydraulic tine adjustment and warning signs + lighting	USD	21,088.00
07015-6-025	AS 1200 M1 scissor folding incl. hydraulic tine adjustment and warning signs + lighting	USD	24,901.00



Tined Weeder Pro

VS 150 M1 / VS 300 M1 / VS 600 M1 / VS 750 M1 VS 900 M1 / VS 1200 M1



Technical data



Items included

Working width	5.58 ft / 10.50 ft / 20.34 ft / 24.93 ft / 30.18 ft / 40.03 ft
Transport dimensions (folded).....	VS 150 M1: H 4.10 ft x W 5.97 ft x D 7.55 ft
.....	VS 300 M1: H 4.10 ft x W 10.79 ft x D 7.55 ft
.....	VS 600 M1: H 9.35 ft x W 9.84 ft x D 7.87 ft
.....	VS 750 M1: H 11.65 ft x W 9.84 ft x D 7.87 ft
.....	VS 900 M1: H 11.65 ft x W 9.84 ft x D 7.87 ft
.....	VS 1200 M1: H 11.65 ft x W 9.84 ft x D 7.87 ft
Net weight.....	551.16 lbs / 815.71 lbs / 1,984.16 lbs / 2,314.85 lbs / 2,866.01 lbs / 3,417.17 lbs
Tine length.....	20.5 in
Tine diameter.....	0.3 in
Tine spacing.....	1.4 in
Number of tines.....	50 pcs. / 92 pcs. / 178 pcs. / 218 pcs. / 266 pcs. / 350 pcs.
Mounting category.....	CAT 2 and CAT 2N
Feeler wheels (16.0/6,5-8" tires).....	2 pcs. / 2 pcs. / 4 pcs. / 4 pcs. / 4 pcs. / 6 pcs.
Tractor performance.....	11 kW / 15 HP; 22 kW / 30 HP; 44 kW / 60 HP; 51 kW / 70 HP; 63 kW / 85 HP; 74 kW / 100 HP

- Complete machine with cranked tines arranged on 6 rows
- Per tine one set of springs
- Sophisticated tine spring system
- Hydraulic tine adjustment

Can be used with Pneumatic Seeders with electric / hydraulic fan PS 120 M1, PS 200 M1 and PS 300 M1:

A double-acting control unit for folding is required
 A double-acting control unit for the central tine pre-load is required

see page 10.
 1 Transport instruction: The Tined Weeder Pro is delivered partly assembled.

Item no.	Tined Weeder Pro ¹	
07027-1-000	VS 150 M1 ¹	USD 8,712.00
07028-1-000	VS 300 M1 ¹	USD 10,466.00
07018-6-015	VS 600 M1 ¹	USD 23,441.00
07019-6-004	VS 750 M1 ¹	USD 28,584.00
07020-6-022	VS 900 M1 ¹	USD 32,961.00
07014-6-054	VS 1200 M1 ¹	USD 41,502.00



Accessories for VS 150 M1 & VS 300 M1

Tines with carbide coating

To reduce tine wear, the VS can be equipped with tines with soldered carbide. Endurance tests show that this tine wears more slowly. This considerably extends the service life until the necessary tine change. The soldered-on carbide plate has a length of 2.4 in.



Item no.	Carbide tines		
07027-2-016	Accessory kit carbide tines for VS 150 M1	USD	1,250.00
07028-2-012	Accessory kit carbide tines for VS 300 M1	USD	1,980.00

Warning signs and lighting

Warning signs with lighting are available as accessories for the VS. For retrofitting please also indicate your serial number!

For front operation of the VS 300 M1, separate warning signs with lighting are available as accessories.



Item no.	Warning signs + lighting		
07028-2-024	Warning signs + lighting VS 300 M1.	USD	772.00
07028-2-025	Warning signs + lighting VS 300 M1 front.	USD	1,405.00

Accessory kit feeler wheels

The VS can be equipped with feeler wheels at the rear. Instead of the support legs a cross beam is mounted. The feeler wheels at the rear are swiveling. If necessary, the swivel function can be locked with a bolt without tools.

If the VS is operated at the front, the rotating feeler wheels should be used instead of the rigid ones. The rear and front feeler wheel brackets can be shifted in width as required to adjust the track width.



Item no.	Accessory kit feeler wheels		
07027-2-018	Accessory kit feeler wheels rear for VS 150 - 300 M1	USD	1,344.00
07027-2-022	Accessory kit feeler wheels front for VS 150 - 300 M1	USD	1,344.00

Accessory kit bracket for Pneumatic Seeder or Multi-Metering System

Use this bracket to fix a Pneumatic Seeder PS 120 - 200 M1 or a Multi-Metering System MDP 100 M1 on the VS.



Item no.	Accessory kit bracket for PS or MD		
07027-2-019	Accessory kit bracket for Pneumatic Seeder PS.	USD	325.00
07027-2-032	Accessory kit bracket for Multi-Metering System MD.	USD	469.00

Accessory kit platform kit

A suitable platform kit is available as an accessory to easily get to the Pneumatic Seeder.



Item no.	Accessory kit platform kit VS		
07027-2-017	Accessory kit platform kit VS 150 M1.....	USD	745.00
07028-2-013	Accessory kit platform kit VS 300 M1.....	USD	985.00

Dispersion plate installation

If a PS is attached on the VS, you need brackets for the dispersion plates. The standard position of the dispersion plates is in front of the harrow section. Everything is already mounted at the factory. The even distances between the dispersion plates ensure uniform field emergence of the nurse crops or similar.



Note: When using a Pneumatic Seeder PS 8 dispersion plates are required. When using a Multi-Metering System MDP 6 dispersion plates are required.

Item no.	Dispersion plate installation		
07027-2-020	Accessory kit dispersion plate installation 8 outlets for VS 150 M1 (for PS)	USD	437.00
07027-2-021	Accessory kit dispersion plate installation 6 outlets for VS 150 M1 (for MDP)	USD	384.00
07028-2-014	Accessory kit dispersion plate installation 8 outlets for VS 300 M1 (for PS)	USD	577.00
07028-2-015	Accessory kit dispersion plate installation 6 outlets for VS 300 M1 (for MDP)	USD	526.00

Manual tine EXCAVATION

With the manual tine excavation, individual tines can be lifted, e.g. to avoid working on plants that have already grown higher in row crops. In this way the harrow is optimally adjusted for bed-cultivation.

Either the entire harrow can be equipped or any number of tine extensions can be selected. To activate the tine excavation, the flat blank has to be pushed in the direction of the tine.



Item no.	Manual tine excavation		
07027-2-024	Accessory kit tines excavation for VS 150 M1.....	USD	772.00
07028-2-019	Accessory kit tines excavation for VS 300 M1.....	USD	1,393.00
07014-2-351	Single tine excavation	USD	15.00

Accessory kit front mounting bracket

An additional mounting bracket can be mounted on the VS 150 & VS 300, to drive the Tined Weeder Pro in front and rear.



Item no.	Accessory kit front mounting bracket		
07027-2-008	Accessory kit front mounting bracket for VS 150-300 M1	USD	648.00
07027-2-025	Accessory kit hydraulic hose extension for VS 150-300 M1.....	USD	207.00

Accessories for VS 600 M1 - VS 1200 M1

Tines with carbide coating

To reduce tine wear, the VS can be equipped with tines with soldered carbide. Endurance tests show that this tine wears more slowly. This considerably extends the service life until the necessary tine change. The soldered-on carbide plate has a length of 2.4 in.



Item no.	Carbide tines		
07018-2-034	Accessory kit carbide tines for VS 600 M1	USD	3,961.00
07019-2-012	Accessory kit carbide tines for VS 750 M1	USD	4,852.00
07020-2-036	Accessory kit carbide tines for VS 900 M1	USD	5,919.00
07014-2-299	Accessory kit carbide tines for VS 1200 M1	USD	7,788.00

Warning signs and lighting

Warning signs with lighting are available as accessories for the VS. For retrofitting please also indicate your serial number!



Item no.	Warning signs + lighting		
07014-2-544	Warning signs + lighting VS.	USD	978.00

Accessory kit feeler wheels at the rear

The VS can be equipped with feeler wheels at the rear. Instead of the support legs a cross beam is mounted. The feeler wheels at the rear are swiveling. If necessary, the swivel function can be locked with a bolt without tools.



Item no.	Accessory kit feeler wheels rear		
07014-2-384	Accessory kit feeler wheels rear	USD	1,352.00

Accessory kit bracket for Pneumatic Seeder PS

Use this bracket to fix the Pneumatic Seeder PS 120 - 500 on the VS.

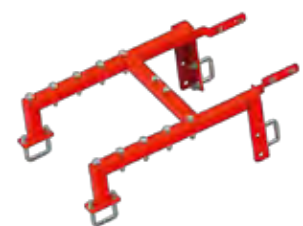

Item no.	Accessory kit PS bracket		
07014-2-385	Accessory kit PS bracket	USD	599.00

Accessory kit platform kit

A suitable platform kit is available as an accessory to easily get to the Pneumatic Seeder.

Item no.	Accessory kit platform kit VS		
07014-2-386	Accessory kit platform kit VS (without feeler wheels at the rear)	USD	1,113.00
07014-2-387	Accessory kit platform kit rear VS (with feeler wheels at the rear)	USD	1,180.00



Dispersion plate installation

If a PS is attached on the VS, you need brackets for the dispersion plates. The standard position of the dispersion plates is in front of the harrow section. Everything is already mounted at the factory. The even distances between the dispersion plates ensure uniform field emergence of the nurse crops or similar.

Item no.	Dispersion plate installation		
07018-2-033	Accessory kit dispersion plate installation for VS 600 M1	USD	172.00
07019-2-011	Accessory kit dispersion plate installation for VS 750 M1	USD	342.00
07020-2-035	Accessory kit dispersion plate installation for VS 900 M1	USD	342.00
07014-2-298	Accessory kit dispersion plate installation for VS 1200 M1	USD	342.00



Manual tine EXCAVATION

With the manual tine excavation, individual tines can be lifted, e.g. to avoid working on plants that have already grown higher in row crops. In this way the harrow is optimally adjusted for bed-cultivation. Either the entire harrow can be equipped or any number of tine extensions can be selected. To activate the tine excavation, the flat blank has to be pushed in the direction of the tine.

Item no.	Manual tine excavation		
07018-2-047	Accessory kit tines excavation for VS 600 M1	USD	2,590.00
07019-2-015	Accessory kit tines excavation for VS 750 M1	USD	3,172.00
07020-2-049	Accessory kit tines excavation for VS 900 M1	USD	3,870.00
07014-2-363	Accessory kit tines excavation for VS 1200 M1	USD	5,093.00
07014-2-351	Single tine excavation	USD	15.00



Accessory kit half-side folding

With the half-side folding, the left and right sides of the Tined Weeder Pro can be folded in and out independently from the driver's seat.

Item no.	Accessory kit half-side folding		
07014-2-624	Accessory kit half-side folding VS	USD	422.00



Snow and Ice Removal Spreaders

WD 40 M2



Technical data

Working width . . . 3 – 17 ft with salt
 Dimensions H 23.62 in x W 17.72 in x D 23.62 in
 Hopper 1.4 cu ft plastic hopper (approx. 110.4 lbs salt)
 Net weight 50.71 lbs
 Power data 12 V / 30 A



Items included

- Electric Control Box 2.10 with steel bracket for mounting in the driver's cab
- Frame with CDC coating (usual in the car industry)
- Spreading disc, agitator, motor shaft and metering slider made of stainless steel
- Complete spreader with electric spreading disc and adjustable throwing vanes
- 1 deflector, top link mounting, counter plate
- 9.84 ft cable for power supply from the battery to the Control Box, 19.69 ft cable from the spreader to the Control Box

Item no.	Snow and Ice Removal Spreader	
05001-1-001	WD 40 M2	USD 1,806.00

Only use dry and fine salt with the Snow and Ice Removal Spreader!

Item no.	Accessories	
00300-1-001	Pick-up mounting bracket	USD 363.00
00300-2-107	Mounting kit towing hitch	USD 398.00
00300-2-022	Mounting kit quad (ATV) bracket height-adjustable	USD 389.00
00410-2-190	Extension cable ES SS 16.40 ft.	USD 93.00

Can be used with tractors, communal tractors, small tractors, powerful quads (ATV) or off-road vehicles.



Snow and Ice Removal Spreaders

UDW 100 M1 / UDW 250 M1



Technical data



Items included

Working width	3 – 20 ft with salt or grit
Max. metering quantity.....	up to 44.09 lbs salt / minute
Dimensions.....	H 43.31 in x W 21.65 in x D 21.65 in (UDW 100 M1)
 H 51.18 in x W 39.37 in x D 33.46 in (UDW 250 M1)
Hopper.....	H 43.3" x W 21.7" x D 21.7" (UDW 100 M1)
 H 51.2" x W 39.4" x D 33.5" (UDW 250 M1)
Net weight.....	101.41 lbs / 176.37 lbs
Power data.....	12 V / 30 A

- Frame with CDC coating (common in car industry)
- Complete metering unit made of stainless steel
- Complete spreader with electric spreading disc with 4 adjustable throwing vanes and electric seeding shaft
- 1 deflector, top link mounting, counter plate, calibration bag
- 1 Flex seeding shaft with 3.1 in diameter
- 9.84 ft cable for power supply from the battery to the 3-pin plug and 4.9 ft cable from the 3-pin plug to the Control Box
- 19.69 ft cable from the spreader to the Control Box

Item no.	Snow and Ice Removal Spreader		
11003-6-000	UDW 100 M1 ¹	USD	3,539.00
11004-6-005	UDW 250 M1 ¹	USD	4,439.00

Only use dry and fine salt with the Snow and Ice Removal Spreaders!
You require a suitable Control Box:

Item no.	Control Box		
00300-2-301 ..	Control Box 1.2 (Accessory kit).....	USD	794.00
00300-2-042 ..	Control Box 5.2 (Accessory kit).....	USD	1,466.00

Item no.	Accessories		
00410-2-185	Calibration button	USD	133.00
11000-2-060	Accessory kit fill level sensor for UDW 100 M1	USD	251.00
04000-2-441	Accessory kit fill level sensor for UDW 250 M1	USD	344.00
00300-1-001	Pick-up mounting bracket	USD	363.00
00410-2-148	Extension cable PS MX 6.56 ft	USD	166.00
00410-2-149	Extension cable PS MX 16.40 ft	USD	222.00
11003-2-025	Accessory kit shovel bracket.....	USD	133.00
11003-2-028	Accessory kit calibration slide.....	USD	71.30
11004-2-019	Lighting ⁴ with integrated license plate holder.....	USD	394.00



CUMMINGS & BRICKER

www.cummingsandbricker.com
support@cummingsandbricker.com

Effective: 01/01/2021

F.O.B. C&B



www.apv-america.com

PRECISION AG SEEDER WITH ROLLER

ITEMNUMBER	DESCRIPTION	WEIGHT	PRICE
GW250161TRPS300ELEC	8'2" Cultipacker Roller, 16.1" Toothed Ring Roller, PS300 Electric Seeder - *Add Controller*	1866	\$16,499.00
GW250161TRPS300HYD	8'2" Cultipacker Roller, 16.1" Toothed Ring Roller, PS300 Hydraulic Seeder - *Add Controller*	1871	\$19,723.00
GW250209CRPS300ELEC	8'2" Cultipacker Roller, 20.9" Cambridge Roller, PS300 Electric Seeder - *Add Controller*	1606	\$15,902.00
GW250209CRPS300HYD	8'2" Cultipacker Roller, 20.9" Cambridge Roller, PS300 Hydraulic Seeder - *Add Controller*	1616	\$19,126.00

COMBINATION HARROWS

ITEMNUMBER	DESCRIPTION	WEIGHT	PRICE
GK250161TRPS300ELEC	8'2" Combination Harrow, 16.1" Toothed Ring Roller, PS300 Electric Seeder - *Add Controller*	2778	\$24,295.00
GK250161TRPS300HYD	8'2" Combination Harrow, 16.1" Toothed Ring Roller, PS300 Hydraulic Seeder - *Add Controller*	2983	\$27,519.00
GK250209CRPS300ELEC	8'2" Combination Harrow, 20.9" Cambridge Roller, PS300 Electric Seeder - *Add Controller*	2557	\$23,699.00
GK250209CRPS300HYD	8'2" Combination Harrow, 20.9" Cambridge Roller, PS300 Hydraulic Seeder - *Add Controller*		\$26,923.00

PRO HARROWS

ITEMNUMBER	DESCRIPTION	WEIGHT	PRICE
GP300209CRPS300ELEC	9'10" Pro Tined Harrow, 20.9" Cambridge Roller, PS300 Electric Seeder - *Add Controller*	3594	\$29,962.00
GP300209CRPS300HYD	9'10" Pro Tined Harrow, 30.9 Cambridge Roller, PS300 Hydraulic Seeder - *Add Controller*	3799	\$33,186.00



Toothed Ring Roller

GW 250 Cultipacker Rollers

- Warning signs & lights GP300 M1
- Mounted bracket kit of PS
- Mounted dispersion plates GW 250
- Mounted access platform for GW
- Sensor set: GPSa sensor & tractor linkage upper bar sensor

GK 250 Combination Harrows

- Warning signs & lights
- Sensor set: GPSa sensor & tractor linkage upper bar sensor
- Mounted dispersion plates GW 250
- Mounted access platform for GW
- Mounted bracket kit for PS

GP 300 Pro Harrows

- Warning signs & lights GP300 M1
- Sensor set: GPSa sensor & tractor linkage upper bar sensor
- Accessory kit dispersion plate assembly GP 300
- Access platform for GP 300 M1



Cambridge Roller

PS 300 PNEUMATIC SEEDERS

FEATURES/OPTIONS



Durable polyethylene hopper with precision applications across working width. Auto matic calibration of application rate at desired speed and width.

Electric or Hydraulic Fan available

5.2 Controller



6.2 Controller

Calibration Button



Filling steps, ascending aid, installation material



1 hollow profile 30x20 mm, 8 clamping plates for the baffle plate, installation material



GPSa Sensor



2nd support for the roller, PS bracket, installation material

CHOICE OF CONTROLLER

ITEMNUMBER	DESCRIPTION	PRICE
002023218	5.2 Controller - PS Series Pneumatic Seeders	\$1,466.00
003002214	6.2 Controller - Touch Screen - Upgrade From 5.2 Controller	\$2,554.00

100-120 LEHIGH AVE.
P.O. BOX 928
BATAVIA, NY 14021
PHONE: 800-252-1552 FAX: 888-852-7406

100 STOVER DRIVE
CARLISLE, PA 17015
PHONE: 800-222-8969
FAX: 717-249-9384



APV America Inc.
370 Highport Road. Ste 101, PO BOX 2381
Pottsboro, TX 75076 - 800-644-9481
info@apv-america.com • www.apv-america.com

FOLLOW APV AMERICA INC. ON SOCIAL MEDIA!

 www.facebook.com/APVAmerica

 https://www.youtube.com/channel/UCITBGve4X_05YZiW5tXZTtQ

 twitter.com/APVAmerica

APV®
www.apv-america.com

Information without guarantee, errors, and omissions accepted! All pictures are symbolic pictures.

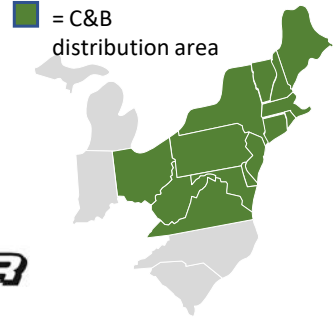

SKID STEER MOUNTED STUMP GRINDERS

Model	Recommended G.P.M. (Ideal)	Maximum GPM*	Included Attachment	Requires Case Drain	Hydraulic Couplers	Motor Options	Price without Adapter	Price with adapter
Hydraulic Drive Skid Steer Stump Grinder with Self Regulated In-feed								
S14	10-15	16 GPM*	Mini skid steer ~	No	Included ***	S250	\$2,940	\$3,060
	12-22	23 GPM*	Mini skid steer ~	No	Included ***	S450	\$3,280	\$3,400
Hydraulic Drive Skid Steer Stump Grinder with Self Regulated In-feed								
S16	10-15	16 GPM*	Mini skid steer ~	Yes	Included ***	S400	\$3,620	\$3,740
Hydraulic Drive Skid Steer Stump Grinder with Self Regulated In-feed								
S18	12-22	23 GPM*	Universal skid steer	No	Included ***	S450	\$4,360	\$4,560
	12-27	28 GPM*	Universal skid steer	Yes **	Not Included ***	S550	\$4,592	\$4,792
	25-40	42 GPM*	Universal skid steer	Yes **	Not Included ***	S650	\$4,980	\$5,180
Hydraulic Drive Skid Steer Stump Grinder with Swing Cylinder								
S24	20-26	28 GPM*	Universal skid steer	Yes **	Not Included ***	S445		\$6,700
	22-32	35 GPM*	Universal skid steer	Yes **	Not Included ***	S545		\$7,040
Hydraulic Drive Skid Steer Stump Grinder with Swing Cylinder								
S28	30-40	42 GPM*	Universal skid steer	Yes **	Not Included ***	S645		\$7,880
Hydraulic Drive Skid Steer Stump Grinder with Swing Cylinder								
S40	20-26	28 GPM*	Universal skid steer	Yes **	Not Included ***	S740		\$10,520
	22-32	35 GPM*	Universal skid steer	Yes **	Not Included ***	S770		\$11,800
Interchangeable Attachment Options on following pages								

Critical not to exceed | *Dealer is responsible to connect, see catalogue for port sizes*

Specify carrier model when ordering attachment | *Not required for bottom GPM range*

3-POINT HITCH MOUNT - PTO DRIVE

Model	Recommended Hp (Ideal)	Hitch Category	Maximum Engine HP*	Required flow	Required Remotes	RPM	Price
PTO Drive 3-Point Hitch Stump Grinder							
1P24	20-40	1	45 HP*	0	0	540	\$2,716
<i>Tractor must have hydrostatic drive</i>							
D002043	Two 1P24 stump grinders shipped as a package, second unit must be for show and tell at dealer ~						\$4,074
D002044	Two 1P24 stump grinders shipped as a package, plus a D001645 show room banner~						\$4,114
PTO Drive 3-Point Hitch Stump Grinder							
3P24	30-50	1 or 2	70 HP*	5-20	2	540	\$5,840
<i>S1050 recommended for improved feathering control on smaller tractors, valve is close center</i>							
PTO Drive 3-Point Hitch Stump Grinder							
3P34	50-75	2	80 HP*	5-20	2	540	\$7,360
PTO Drive 3-Point Hitch Stump Grinder High Hp							
3P40	60-120	2	125 HP*	5-20	2	1000	\$9,400

~See dealer support document for details



EXCAVATOR MOUNTED STUMP GRINDERS

Model	Recommended G.P.M. (Ideal)	Maximum GPM*	Tooth Type	Requires Case Drain	Hydraulic Couplers	Motor Options	Price without Adapter
Hydraulic Drive Excavator Stump Grinder with Self Regulated In-feed							
S14	10-15	16 GPM*	Green Teeth	No	Not Included ***	S250	\$2,940
	12-22	23 GPM*	Green Teeth	No	Not Included ***	S450	\$3,280
Hydraulic Drive Excavator Stump Grinder with Self Regulated In-feed							
S18	12-22	23 GPM*	Planer teeth	No	Not Included ***	S450	\$4,360
	12-27	28 GPM*	Planer teeth	Yes **	Not Included ***	S550	\$4,592
	20-35	38 GPM*	Planer teeth	Yes **	Not Included ***	S650	\$4,980
Hydraulic Drive Excavator Stump Grinder with Self Regulated In-feed							
GXM350	8-15	18 GPM*	Green Teeth	Critical	Not Included ***	X508	\$6,120
	12-25	28 GPM*	Green Teeth	Critical	Not Included ***	X510	\$6,320
	15-30	34 GPM*	Green Teeth	Critical	Not Included ***	X530	\$6,760
Hydraulic Drive Excavator Stump Grinder with Self Regulated In-feed							
GXM550	8-15	18 GPM*	Green Teeth	Critical	Not Included ***	X508	\$7,480
	12-25	28 GPM*	Green Teeth	Critical	Not Included ***	X510	\$7,680
	15-30	34 GPM*	Green Teeth	Critical	Not Included ***	X530	\$8,120
	20-35	38 GPM*	Green Teeth	Critical	Not Included ***	X540	\$8,320
	25-40	44 GPM*	Green Teeth	Critical	Not Included ***	X550	\$8,360
Hydraulic Drive Excavator Stump Grinder with Self Regulated In-feed							
GXM750	20-35	38 GPM*	Green Teeth	Critical	Not Included ***	X540	\$9,120
	25-40	44 GPM*	Green Teeth	Critical	Not Included ***	X550	\$9,160
	30-50	54 GPM*	Green Teeth	Critical	Not Included ***	X570	\$10,080
	40-70	71 GPM*	Green Teeth	Critical	Not Included ***	X590	\$10,960

* Critical not to exceed

** Not required for bottom GPM range

*** Dealer is responsible to connect, see catalogue for port sizes

**Walk Behind Stump Grinder**

Model	Description	Engine Horsepower	Pieces Per Order	Volume Discount	List price
WB44	Walk Behind One Piece	13Hp Honda Engine	1	0	\$4,560
WB44	Walk Behind/ Two Pieces	13Hp Honda Engine	2	5%	\$4,332
WB44 Volume	Walk Behind/ Three or more	13Hp Honda Engine	3 or more	10%	\$4,104

Walk Behind Bundle & Save*

Model	Description	Engine Horsepower	Pieces Per Order	One to show	List price
WB44 Show & Tell	Walk Behind/ Two Pieces	13Hp Honda Engine	2	10%	\$4,104
	Walk Behind/ Three or more	13Hp Honda Engine	3 or more	15%	\$3,876
WB44 Bundle	Bundle a WB44 with any other Baumalight whole good.	13Hp Honda Engine	2 Total	Lowest value item @ 10%	Call for clarification
WB44 Bundle	Bundle a WB44 with any other Baumalight whole good that is stackable for shipping.	13Hp Honda Engine	2 Total	Lowest value item @ 15%	Call for clarification
WB44 Bundle	Bundle a WB44 with any TX or 1P24	13Hp Honda Engine	2 Total	Lowest value item @ 50%	Call for clarification

All must ship in one lot direct to dealer from factory

* One must be for trade show or showroom display





Adaptors And Parts

Part number	Skid Steer Attachment Adaptors	Pivot Pin size	Price
D001126	S14 or S18 Mini Skid Steer Attachment	1"	\$120
D001943	S14 or S18 Bob Cat Mini Skid Steer Attachment (35.5" wide)	1"	\$220
D001127	S14 or S18 Universal Skid Steer Attachment	1"	\$200
D003504	S14 or S18 ASV & Terex RC30 & PT30 Skid Steer Plate	1"	\$212
Part number	Bucket Mount Adaptor	Pivot Pin size	Price
D001427	S14 or S18 Bucket Mount Adaptor	1"	\$384
Part number	Excavator Adaptors	Pivot Pin size	Price
D002112	Weld-on S14 or S18 Excavator Adaptor (parts only) <i>unpainted</i>	1"	\$104
D001421	Weld-on S14 or S18 Excavator Adaptor (assembled) <i>drawing available</i>	1"	\$280
D001161	Blank Weld-on Plate for GXM350,GXM550 or GXM750	bolt on	\$96

See mulcher section for Turn Key Excavator adaptors

Part number	Control options	Price
E2068	Control cable, price per foot (S24 & S28,include 10' cable)	\$22
S1050	Hydraulic valve kit for all 3P models. For use when tractor has only one set of remotes.	\$680
<i>S1050 recommended for improved feathering control on smaller tractors (add \$250 if shipped later)</i>		



3-Point Hitch Mulcher

New Model	Description	PTO RPM	Hydraulic Hose/Couplers	Price
MP248	PTO Drive 3-point Hitch Brush Mulcher - 62" Path Width, 48" Blade Width			
	20-30 HP CAT 1	540 rpm	Not needed	Quote
MP348	PTO Drive 3-point Hitch Brush Mulcher - 62" Path Width, 48" Blade Width			
	25-45 HP CAT 1	540 rpm	Not needed	\$10,080
MP360	PTO Drive 3-point Hitch Brush Mulcher - 72" Path Width, 60" Blade Width			
	30-50 HP CAT 1	540 rpm	Not needed	\$11,400
MP560	PTO Drive 3-point Hitch Brush Mulcher - 75" Path Width, 60" Blade Width			
	45-65 HP CAT 2. Do not exceed 68HP*	540 rpm	Included	\$16,440
MP572	PTO Drive 3-point Hitch Brush Mulcher - 84" Path Width, 72" Blade Width			
	60-120 HP CAT 2. Do not exceed 135 HP*	1000 rpm	Included	\$23,600
	110 Hp 540 Gearbox option - Installed at factory **	540 rpm	1-3/8" 6-Spline	\$25,100
iMP772 & MP972	PTO Drive 3-point Hitch Brush Mulcher - 84" Path Width, 72" Blade Width			
	100-120 HP CAT 2. Do not exceed 135 HP*	1000 rpm	1.375" 21-spline	\$33,600
	110 Hp 540 Gearbox option - Installed at factory **	540 rpm	1-3/8" 6-Spline	\$35,100
	Larger shaft to up the HP (1,000 RPM only)			
	100-150 HP CAT 2. Do not exceed 165 HP*	1000 rpm	1.75" 20-spline	\$1,480

*NOTICE this value must never be exceeded or warranty is voided

** Priced different if field installed (Shaft and Gearbox priced as parts)



Excavator Mulcher

New Model	Recommended G.P.M. (Ideal)	Maximum GPM*	Adaptor	Requires Case Drain	Hydraulic Hose/Couplers	Motor option	Price
Hydraulic Drive Excavator Brush Mulcher - 40" Path Width, 30" Blade Width							
MX230	12-19	20 GPM*	Not supplied	No	Not supplied	Dedicated	\$4,784
Hydraulic Drive Excavator Brush Mulcher - 40" Path Width, 30" Blade Width							
MX330	12-19	20 GPM*	Not supplied	No	Not supplied	Dedicated	\$7,344
Hydraulic Drive Excavator Brush Mulcher - 40" Path Width, 30" Blade Width							
MX530	1,200 rpm	See literature or website	Not supplied	No	Not included	A450	\$10,640
	1,200 rpm	See literature or website	Not supplied	Yes	Not included	B550	\$10,880
	1,800 rpm	See literature or website	Not supplied	Yes	Not included	C508	\$13,560
	1,800 rpm	See literature or website	Not supplied	Yes	Not included	C510	\$13,720
	1,800 rpm	See literature or website	Not supplied	Yes	Not included	C530	\$14,560
	1,800 rpm	See literature or website	Not supplied	Yes	Not included	C540	\$14,760
	1,800 rpm	See literature or website	Not supplied	Yes	Not included	C550	\$14,880
Hydraulic Drive Excavator Brush Mulcher - 65" Path Width, 48" Blade Width							
MX548	1,800 rpm	See literature or website	Not supplied	Yes	Not included	C508	\$16,440
	1,800 rpm	See literature or website	Not supplied	Yes	Not included	C510	\$16,600
	1,800 rpm	See literature or website	Not supplied	Yes	Not included	C530	\$17,440
	1,800 rpm	See literature or website	Not supplied	Yes	Not included	C540	\$17,640
	1,800 rpm	See literature or website	Not supplied	Yes	Not included	C550	\$17,760
	1,800 rpm	See literature or website	Not supplied	Yes	Not included	C570	\$18,160
	1,800 rpm	See literature or website	Not supplied	Yes	Not included	C590	\$18,960
Hydraulic Drive Excavator Brush Mulcher - 65" Path Width, 48" Blade Width							
MX548R	1,800 rpm	See literature or website	Not supplied	Yes	Not included	C508	\$16,920
	1,800 rpm	See literature or website	Not supplied	Yes	Not included	C510	\$17,080
	1,800 rpm	See literature or website	Not supplied	Yes	Not included	C530	\$17,920
	1,800 rpm	See literature or website	Not supplied	Yes	Not included	C540	\$18,120
	1,800 rpm	See literature or website	Not supplied	Yes	Not included	C550	\$18,240
	1,800 rpm	See literature or website	Not supplied	Yes	Not included	C570	\$18,640
	1,800 rpm	See literature or website	Not supplied	Yes	Not included	C590	\$19,440
Hydraulic Drive Excavator Brush Mulcher - 65" Path Width, 48" Blade Width							
iMX748	1,800 rpm	See literature or website	Not supplied	Yes	Not included	C740	\$23,560
	1,800 rpm	See literature or website	Not supplied	Yes	Not included	C750	\$23,680
	1,800 rpm	See literature or website	Not supplied	Yes	Not included	C770	\$24,080
	1,800 rpm	See literature or website	Not supplied	Yes	Not included	C790	\$24,880
Ripper Hydraulic Drive Excavator Brush Mulcher - 65" Path Width, 48" Blade Width							
iMX748R	1,800 rpm	See literature or website	Not supplied	Yes	Not included	C740	\$25,720
	1,800 rpm	See literature or website	Not supplied	Yes	Not included	C750	\$25,840
	1,800 rpm	See literature or website	Not supplied	Yes	Not included	C770	\$26,240
	1,800 rpm	See literature or website	Not supplied	Yes	Not included	C790	\$27,040
Ripper Hydraulic Drive Excavator Brush Mulcher - 90" Path Width, 60" Blade Width							
iMX760R & MX960R	1,800 rpm	See literature or website	Not supplied	Yes	Not included	C740	\$29,480
	1,800 rpm	See literature or website	Not supplied	Yes	Not included	C750	\$29,600
	1,800 rpm	See literature or website	Not supplied	Yes	Not included	C770	\$30,000
	1,800 rpm	See literature or website	Not supplied	Yes	Not included	C790	\$30,800
Ripper Hydraulic Drive Excavator Brush Mulcher - 90" Path Width, 60" Blade Width							
MX1160R	1,800 rpm	See literature or website	Not supplied	Yes	Not included	C740	\$33,480
	1,800 rpm	See literature or website	Not supplied	Yes	Not included	C750	\$33,600
	1,800 rpm	See literature or website	Not supplied	Yes	Not included	C770	\$34,000
	1,800 rpm	See literature or website	Not supplied	Yes	Not included	C790	\$34,800

*NOTICE this value must never be exceeded or warranty is voided **Not required for bottom GPM range



Skid Steer Mulcher

New Model	Recommended G.P.M. (Ideal)	Maximum GPM*	Adaptor	Requires Case Drain	Hydraulic Hose/Couplers	Motor option	Price
Hydraulic Drive Skid Steer Brush Mulcher - 62" Path Width, 48" Blade Width							
MS248	12-19	20 GPM*	Skid steer	No	Included	Dedicated	\$4,792
Hydraulic Drive Skid Steer Brush Mulcher - 62" Path Width, 48" Blade Width							
MS348	12-19	20 GPM*	Skid steer	No	Included	Dedicated	\$8,636
Hydraulic Drive Skid Steer Brush Mulcher - 62" Path Width, 48" Blade Width							
MS548	1,200 rpm	See literature or website	Skid steer	No	Included	A450	\$13,280
	1,200 rpm	See literature or website	Skid steer	Yes **	Included ***	B550	\$13,520
	1,800 rpm	See literature or website	Skid steer	Yes	Hoses only	C508	\$16,200
	1,800 rpm	See literature or website	Skid steer	Yes	Hoses only	C510	\$16,360
	1,800 rpm	See literature or website	Skid steer	Yes	Hoses only	C530	\$17,200
	1,800 rpm	See literature or website	Skid steer	Yes	Hoses only	C540	\$17,400
Hydraulic Drive Skid Steer Brush Mulcher - 75" Path Width, 60" Blade Width							
MS560	1,800 rpm	See literature or website	Skid steer	Yes	Hoses only	C508	\$18,520
	1,800 rpm	See literature or website	Skid steer	Yes	Hoses only	C510	\$18,680
	1,800 rpm	See literature or website	Skid steer	Yes	Hoses only	C530	\$19,520
	1,800 rpm	See literature or website	Skid steer	Yes	Hoses only	C540	\$19,720
	1,800 rpm	See literature or website	Skid steer	Yes	Hoses only	C550	\$19,840
Hydraulic Drive Skid Steer Brush Mulcher - 75" Path Width, 60" Blade Width							
MS572	1,800 rpm	See literature or website	Skid steer	Yes	Hoses only	C530	\$21,280
	1,800 rpm	See literature or website	Skid steer	Yes	Hoses only	C540	\$21,480
	1,800 rpm	See literature or website	Skid steer	Yes	Hoses only	C550	\$21,600
Hydraulic Drive Skid Steer Brush Mulcher - 75" Path Width, 60" Blade Width							
IMS760	1,800 rpm	See literature or website	Skid steer	Yes	Hoses only	C730	\$25,360
	1,800 rpm	See literature or website	Skid steer	Yes	Hoses only	C740	\$25,560
	1,800 rpm	See literature or website	Skid steer	Yes	Hoses only	C750	\$25,680
	1,800 rpm	See literature or website	Skid steer	Yes	Hoses only	C770	\$26,080
Hydraulic Drive Skid Steer Brush Mulcher - 84" Path Width, 72" Blade Width							
IMS772	1,800 rpm	See literature or website	Skid steer	Yes	Hoses only	C740	\$27,480
	1,800 rpm	See literature or website	Skid steer	Yes	Hoses only	C750	\$27,600
	1,800 rpm	See literature or website	Skid steer	Yes	Hoses only	C770	\$28,000
	1,800 rpm	See literature or website	Skid steer	Yes	Hoses only	C790	\$28,800
Hydraulic Drive Skid Steer Brush Mulcher - 75" Path Width, 60" Blade Width							
MS960	1,800 rpm	See literature or website	Skid steer	Yes	Hoses only	C930	\$25,680
	1,800 rpm	See literature or website	Skid steer	Yes	Hoses only	C940	\$25,880
	1,800 rpm	See literature or website	Skid steer	Yes	Hoses only	C950	\$26,000
	1,800 rpm	See literature or website	Skid steer	Yes	Hoses only	C970	\$26,400
Hydraulic Drive Skid Steer Brush Mulcher - 84" Path Width, 72" Blade Width							
MS972	1,800 rpm	See literature or website	Skid steer	Yes	Hoses only	C930	\$27,360
	1,800 rpm	See literature or website	Skid steer	Yes	Hoses only	C940	\$27,560
	1,800 rpm	See literature or website	Skid steer	Yes	Hoses only	C950	\$27,680
	1,800 rpm	See literature or website	Skid steer	Yes	Hoses only	C970	\$28,080
Hydraulic Drive Skid Steer Brush Mulcher - 75" Path Width, 60" Blade Width							
MS1160	1,800 rpm	See literature or website	Skid steer	Yes	Hoses only	C1130	\$30,240
	1,800 rpm	See literature or website	Skid steer	Yes	Hoses only	C1140	\$30,440
	1,800 rpm	See literature or website	Skid steer	Yes	Hoses only	C1150	\$30,560
	1,800 rpm	See literature or website	Skid steer	Yes	Hoses only	C1170	\$30,960

Standard hoses are 3/4", add \$500 to upgrade to 1" if installed at the factory

*NOTICE this value must never be exceeded or warranty is voided

**Not required for bottom GPM range



Hydraulic Couplers

Part number	Description	"B" dimension	ISO size	Price
D001061	0.63" x 1/4" NPT Male Quick Coupler	16 / 0.63	6.3	\$ 26
D002111	0.63" x 1/4" NPT FM Quick Coupler	16 / 0.63	6.3	\$ 52
D001062	0.79" x 1/2" NPT Male Quick Coupler	20 / 0.79	10	\$ 44
D002128	0.79" x 1/2" NPT FM Quick Coupler	20 / 0.79	10	\$ 74
D001063	1" x 1/2" NPT Male Standard Flow Quick Coupler	25 / 1.00	12.5	\$ 49
D001096	1" x 1/2" NPT FM Standard Flow Quick Coupler	25 / 1.00	12.5	\$ 74
D002109	1" x 3/4" NPT Male Standard Flow Quick Coupler	25 / 1.00	12.5	\$ 49
D002108	1" x 3/4" NPT FM Standard Flow Quick Coupler	25 / 1.00	12.5	\$ 74
D001064	1.06" x 3/4" NPT Male Quick Coupler	27 / 1.06	16	\$ 71
D001097	1.06" x 3/4" NPT FM Quick Coupler	27 / 1.06	16	\$ 112
D001065	1.18" x 3/4" NPT Male Quick Coupler	30 / 1.18	19	\$ 123
D001090	1.18" x 3/4" NPT FM Quick Coupler	30 / 1.18	19	\$ 185
D001066	1.42" x 3/4" NPT Male Quick Coupler	36 / 1.42	25	\$ 142
D002110	1.42" x 3/4" NPT FM Quick Coupler	36 / 1.42	25	\$ 266
D001093	Pioneer Quick Coupler Male 1/2" NPT			\$ 10
D001094	Pioneer Quick Coupler Female 1/2" NPT			\$ 25

Short Nipples

Part number	Description	JIC size	NPT size	Price
2404.12.12	Male Connector - Male JIC x Male Pipe	3/4"	3/4"	\$ 5
2404.08.08	Male Connector - Male JIC x Male Pipe	1/2"	1/2"	\$ 2
2404.06.08	Male Connector - Male JIC x Male Pipe	3/8"	1/2"	\$ 2



**BAUMALIGHT™**

Flail Teeth and Rotor Wear Parts		Price
F2000	200 series Mulcher Flail Tooth	\$3.60
F3000	6 mm Heavy Flail Blade (sold in singles, set of two required)	\$3.20
D003977	D-Ring F2000 for hanging Flail Tooth	\$2.80
D003978	Clip for hanging Flail Tooth	\$2.40

Stump Grinder and Small Mulcher Teeth and Wear Parts		Bulk Price	Price
G3000	Round GREENTooth - Carbide Tipped 3/8" thread (nut not included)		\$19.20
D002039	24-pack of G3000 GREENTooth Teeth	\$16.00	\$384.00
W3000	Round Wearsharp - Better buy design 5/16" thread (nut not included)		\$20.00
D004930	24-pack of W3000 Wearsharp - Better by design Teeth	\$16.40	\$393.60
H3000	Round High Speed Tooth - Carbid Tipped 3/8" Thread (nut not included)		\$11.20
D004978	24-pack of H3000 teeth	\$8.00	\$192.00
D004931	5/16" Standard Lock Nut for round teeth		\$0.74
D001625	3/8" Standard Lock Nut for round teeth		\$0.76
D001678	Shim for round Tooth		\$1.56
D001679	300 Series Round Tooth Holder - Angled 700LP-A Green (US Patent #US9241448B2)		\$20.00
D005084	300 Series Round Tooth Holder - Angled Baumalight (cannot sell in US)		\$9.60
D002741	Outer Round Tooth Holder - Straight		\$15.60
D001676	Inner (weld-on) plate for outer round tooth holder (300 series mulchers)		\$14.80
D001775	5/8" Bolt for Round Tooth Holder		\$4.40
D002494	G3000 4x Tooth Holder for GXM350 Stump Grinder (AR400)		\$42.40
D002169	G3000 5x Tooth Holder for GXM550/GXM750 Stump Grinder (AR400)		\$96.00
D002930	1/2" x 4.5" Allen Bolt		\$4.40
D003328	1/2" Fine Stover Lock Nut		\$1.40
S1000	Stump Grinder Tooth - 5/8" Fine Thread - 3/4" Square		\$14.40
D001627	24-Pack of S1000 Teeth	\$ 9.20	\$220.80
D001773	5/8" Fine Stover Lock Nut for S1000 Tooth		\$2.08
D002121	52 Pack of 5/8" Fine Nuts for S1000 Tooth	\$ 1.54	\$80.00
D002924	Tooth Holder Block for S1000 Tooth (weld-in)		\$6.72

500 Series Mulcher Teeth and Rotor Wear Parts		Bulk Price	Price
P5000	500 Series Planer Mulcher Tooth		\$14.80
R5000	500 Series Ripper Mulcher Tooth		\$16.40
D001774	24-Pack of 500 Series Planer Teeth	\$ 11.20	\$268.80
D002330	24-Pack of 500 Series Ripper Teeth	\$ 12.00	\$288.00
D001343	Tooth Holder for 500 Series Tooth (weld-on)		\$26.40

See section above for 5/8" fine stover lock nuts

700 Series and Disc Mulcher Teeth and Rotor Wear Parts		Bulk Price	Price
R7000	700 Series Ripper Mulcher Tooth		\$36.00
P7000	700 Series Planer Mulcher Tooth		\$38.40
D002268	30 Pack of 700 Series Ripper Mulcher Teeth	\$ 26.40	\$792.00
D002267	30 Pack of 700 Series Planer Mulcher Teeth	\$ 28.80	\$864.00
D001776	Bolt for 700 Series Mulcher Tooth (5/8" Fine Thread x 3")		\$4.80
D002269	75 Pack of Bolts for 700 Series Mulcher Teeth (5/8" Fine Thread x 3")	\$ 2.40	\$180.00
D001671	Tooth Holder for 700 Series Tooth (weld-on)		\$46.40
D003950	Disc Mulcher Tooth Holder - Down Angle		\$52.00
D002836	Disc Mulcher Tooth Holder - Top		\$56.00
D002837	Disc Mulcher Tooth Holder - Straight		\$37.60
D002860	Disc Mulcher Tooth Holder - Bottom		\$72.00

900 Series Teeth and Rotor Wear Parts			Price
R9000	900 Series Ripper Mulcher Tooth		\$65.60
D005540	14 - Pack of R9000 Series Ripper Mulcher Teeth	\$ 58.40	\$817.60
D004928	Bolt for 900 Series Mulcher Tooth (M20-1.5 x 60) Also for D004728		\$5.60
D004427	Tooth Holder for 900 Series Tooth (weld-on)		\$52.00
T9000	900 Series Bolt-on Planer Tip Tooth		\$30.40
D004728	Bolt-on sub-holder for T9000 tip		\$41.60
D004929	Bolt to bolt-on T9000 tip (M14x1.5x35)		\$4.00

1100 Series Teeth and Rotor Wear Parts			Price
P11000	1100 Series Planer Mulcher Tooth		\$36.00
D004861	12- Pack of 1100 Series Planer Mulcher Teeth	\$ 30.40	\$364.80

See 900 series for bolts & weld-on holder

Beaver Teeth and Rotor Wear Parts			Price
B8000	1100 Series Planer Mulcher Tooth		\$29.60
D004261	Tooth Holder for B8000 Tooth		\$120.00



Auger Drives

U60 List Price, Effective January 1, 2020

MODEL	Torque	Drive	GPM	DESCRIPTION	Drive with Hoses**	Drive Only *
	Max bit size	Drive Size	Adaptor Code	Motor Port thread size		
RC442	540 f-lb	2"	6-14	Standard Duty Gear Drive for 6-24" bits	\$1,608	\$1,400
	24"	Round	A	Used to be B adaptor code		
RC552	Discontinued, Hex drive is much better					
RC556	Discontinued, Hex drive is much better					
RC582	1,529 f-lb	2"	6-24	Standard Duty Planetary Drive for 6-24" bits	\$2,352	\$2,144
	24"	Hex	B	#10 O-ring		
RC586	2,549 f-lb	2"	6-24	Heavy Duty Planetary Drive for 6-48" bits	\$2,808	\$2,600
	48"	Hex	D	#10 O-ring		
RC780	4,000 f-lb	2"	20-40	Heavy Duty Planetary Drive for 6-60" bits	\$3,400	\$3,192
	60"	Hex	D	#16 O-ring (#4 O-ring for case)		

* No hoses or skid steer plate

** Ships with 8ft hoses and flat face skid steer couplers, not recommended for excavator setups (Does not include skid steer plate)

MODEL	GPM	Drive Size	Adaptor Code	Torque	Motor port	Price*
RCH960	12-30	2.5 Hex	F***	3,000 psi - 2,672 ft-lb, 4,000 psi - 3560 ft-lb	3/4" JIC	\$9,600
RCH985	20-40	2.5 Hex	F***	3,000 psi - 4,957 ft-lb, 4,000 psi - 6,611 ft-lb	3/4" JIC	\$10,400
RCH1260	10-30	2.5 Hex	H***	3,000 psi - 2,672 ft-lb, 4,000 psi - 3560 ft-lb	3/4" JIC	\$11,200
RCH1290	25-45	2.5 Hex	H***	3,000 psi - 6,517 ft-lb, 4,000 psi - 8,691 ft-lb	3/4" JIC	\$12,000
RCH12150	40-60	2.5 Hex	H***	3,000 psi - 8,424 ft-lb, 4,000 psi - 11,229 ft-lb	3/4" JIC	\$13,600

***Ships with blank weld-on plate but no hoses

~ case port size is #6 O-ring



Auger Drive Mounts

Adaptor Code	Description
A	A code is for 1" pin size on adaptor mount plate for RC442
B	B code is for 1" pin size on adaptor mount plate
D	D code is for 1.5" Standard pin size on adaptor mount plate
F	F code is for 1.5" Long pin size on adaptor mount plate
H	H code is for 2" pin size on adaptor mount plate

Part Number	Adaptor Code	Description	Operator	Price
-------------	--------------	-------------	----------	-------

BOBCAT MINI SKIDSTEER, ASV RC30 & TERC PT30

D001648	A & B	1" pin Bob Cat mini plate	Owner Operator	\$ 416
D003454	A & B	1" pin ASV & Terex RC30 & PT30	Owner Operator	\$ 446
D003544	D	1.5" pin Bobcat Mini Skidsteer	Construction	\$ 500
D003568	D	1.5" ASV & Terex RC30 & PT30	Construction	\$ 520

BUCKET MOUNT

D001308	B	Bucket mount with 1" cross pin and 8 ft. chain	Owner Operator	\$ 668
D001420	D	Bucket mount with 1.5" cross pin and 8 ft. chain	Owner Operator	\$ 720

MINI SKIDSTEER

D001145	A & B	1" pin Mini Skid steer plate	Owner Operator	\$ 320
D004684	B	1" mini Skidsteer with cradle		\$ 464
D003532	D	1.5" pin mini skidsteer plate	Construction	\$ 472

UNIVERSAL MOUNT

D001369	A & B	1" Pin Standard Universal Skid Steer plate	Owner Operator	\$ 460
D003472	B	1" Pin Standard Skidsteer Adaptor with cradle	Owner Operator	\$ 592
D001032	D	1.5 Pin Heavy Universal Skid Steer plate	Owner Operator	\$ 720
D003473	D	1.5 Pin Heavy Universal Skid Steer plate with cradle	Construction	\$ 760

Excavator Mounting Options

D001328	A & B	Blank for weld-on plate with shear pins (Stock)		\$ 96
D003527	B	1" pin blank weld on plate with Cradle		\$ 212
D001386	D	Blank for weld-on plate (Stock)		\$ 100
D003528	D	1.5" pin blank weld on plate with Cradle		\$ 296
D002014	F	Blank for weld-on plate		\$ 136
D003187	H	Blank for weld-on plate		\$ 168

D001784	Class B	Baumalight turnkey adaptor
D002253	Class D	Baumalight turnkey adaptor
D002254	Class F	Baumalight turnkey adaptor
D002255	Class H	Baumalight turnkey adaptor

See mulcher section for turn key excavator adaptor pricing

HYDRAULIC HOSE KIT

D002118	1/2"	4 ft Hose set (no couplers)	\$ 108
D002119	1/2"	8 ft Hose set (no couplers)	\$ 132
D001698	1/2"	8 ft Skid steer hose set with standard flow couplers	\$ 208

**Aggressor Auger 4x48"**

2" Round	2-9/16	2" HEX	DIMENSIONS diameter x length (inches)	PRICE
103785	135532	135533	4" x 48"	\$496

Aggressor Augers 30"

2" SHAFT	DIMENSIONS diameter x length (inches)	PRICE
137140	6"x30"	\$307
137141	9"x30"	\$309
137142	12"x30"	\$320

AG Augers

2" SHAFT	DIMENSIONS diameter x length (inches)	PRICE
553228	6 X 48	\$316
553229	9 X 48	\$320
553230	12 X 48	\$328

AGGRESSOR Interlok Augers

Sub		DIMENSIONS	PRICE
4" shown above			
157200	Interlok	6" Aggressor Sub	\$214
157201	Interlok	9" Aggressor Sub	\$356
157202	Interlok	12" Aggressor Sub	\$432
157203	Interlok	15" Aggressor Sub	\$576
157204	Interlok	18" Aggressor Sub	\$672
157205	Interlok	24" Aggressor Sub	\$796
157206	Interlok	30" Aggressor Sub	\$1,160
157207	Interlok	36" Aggressor Sub	\$1,440

Interlok Hubs

Sub		DIMENSIONS	PRICE
154015	POSILOCK	BOLT INTERLOK 1/2"	\$30
154073	R-200 Interlok	2" Round	\$133
154074	R-256 Interlok	2-9/16 Round	\$133
154075	H-200 Interlok	2" Hex	\$135
154076	H-250 Interlok	2.5" Hex	\$133

AGGRESSOR Tree Augers

2" SHAFT	2-9/16" SHAFT	2" HEX	DIMENSIONS diameter x length (inches)	PRICE
135578	135542	135554	18" Tree Auger	\$680
135579	135543	135555	24" Tree Auger	\$824
135580	135544	135556	30" Tree Auger	\$1,178
135581	135545	135557	36" Tree Auger	\$1,528

Bolt on Rock Head (replaces teeth and pilot bit)

	137991	6-BOR kit 6" (bolt on rock head)	\$396
	137992	9-BOR kit 9" (bolt on rock head)	\$488
	137993	12-BOR kit 12" (bolt on rock head)	\$528
	137994	15-BOR kit 15" (bolt on rock head)	\$584
	137995	18-BOR kit 18" (bolt on rock head)	\$620
	137996	24-BOR kit 24" (bolt on rock head)	\$760

Wear Parts

	133407	Pilot Bit for 4" auger [SB-45]	\$64
	137990	Pengo P-21 -RR Carbide Bullet Tooth (rock head)	\$18
	D005392	Baumaligh Carbide Bullet Tooth - trencher, also fits rock head	\$11
	134519	40/50 Carbide Tooth (Aggressor)	\$27
	134802	40/50 HFF Hardfaced tooth (Aggressor)	\$17
	D001743	Nut & Bolt for Aggressor tooth	\$7
	135088	T350 Triflow Pilot Bit	\$36



Trencher

MODEL	DESCRIPTION	WEIGHT (lbs)	Chain Option	PRICE
Hydraulic Drive for Skid Steer attachment, requires 12-25 gpm.				
TN236	36x4" Standard cup tooth chain	810	S3604	\$4,760
	36x6" Standard cup tooth chain	820	S3606	\$4,796
	36x4" 50/50 rock & cup tooth chain	830	M3604	\$5,356
	36x6" 50/50 rock & cup tooth chain	840	M3606	\$5,540
Hydraulic Drive for Skid Steer attachment, requires 12-25 gpm.				
TN336	36x4" Standard cup tooth chain	850	S3604	\$5,680
	36x6" Standard cup tooth chain	860	S3606	\$5,716
	36x4" 50/50 rock & cup tooth chain	870	M3604	\$6,276
	36x6" 50/50 rock & cup tooth chain	880	M3606	\$6,460
Hydraulic Drive for Skid Steer attachment, requires 12-25 gpm.				
TN548	48x6" Standard cup tooth chain	1250	S4806	\$5,960
	48x8" Standard cup tooth chain	1260	S4808	\$6,320
	48x10" Standard cup tooth chain	1270	S4810	\$6,620
	48x6" 50/50 rock & cup tooth chain	1284	M4806	\$6,716
	48x8" 50/50 rock & cup tooth chain	1290	M4808	\$7,180
	48x10" 50/50 rock & cup tooth chain	1310	M4810	\$7,516
Hydraulic Drive for Skid Steer attachment, requires 12-25 gpm.				
TN560	60x6" Standard cup tooth chain	1375	S6006	\$6,668
	60x8" Standard cup tooth chain	1386	S6008	\$6,772
	60x10" Standard cup tooth chain	1397	S6010	\$7,340
	60x6" 50/50 rock & cup tooth chain	1412	M6006	\$7,520
	60x8" 50/50 rock & cup tooth chain	1419	M6008	\$8,280
	60x10" 50/50 rock & cup tooth chain	1441	M6010	\$8,440
Hydraulic Drive for Skid Steer attachment, requires 25-40 gpm.				
TN760	60x6" Standard cup tooth chain	1675	S6006	\$8,028
	60x8" Standard cup tooth chain	1686	S6008	\$8,132
	60x10" Standard cup tooth chain	1697	S6010	\$8,700
	60x6" 50/50 rock & cup tooth chain	1712	M6006	\$8,880
	60x8" 50/50 rock & cup tooth chain	1719	M6008	\$9,640
	60x10" 50/50 rock & cup tooth chain	1741	M6010	\$9,800
TNX548	Discontinued			

**Trencher Parts**

SPARE CHAIN		WEIGHT (lbs)	PRICE
S3604	36x4" Standard cup tooth replacement chain	140	\$920
S3606	36x6" Standard cup tooth chain	145	\$956
M3604	36x4" 50/50 rock & cup tooth chain	150	\$1,516
M3606	36x6" 50/50 rock & cup tooth chain	155	\$1,700
S4806	48x6" Standard cup tooth replacement chain	175	\$1,080
S4808	48x8" Standard cup tooth replacement chain	185	\$1,440
S4810	48x10" Standard cup tooth replacement chain	195	\$1,740
M4806	48x6" 50/50 rock & cup tooth replacement chain	209	\$1,836
M4808	48x8" 50/50 rock & cup tooth replacement chain	220	\$2,300
M4810	48x10" 50/50 rock & cup tooth replacement chain	230	\$2,636
S6006	60x6" Standard cup tooth replacement chain	192	\$1,348
S6008	60x8" Standard cup tooth replacement chain	203	\$1,452
S6010	60x10" Standard cup tooth replacement chain	214	\$2,020
M6006	60x6" 50/50 rock & cup tooth replacement chain	230	\$2,200
M6008	60x8" 50/50 rock & cup tooth replacement chain	242	\$2,960
M6010	60x10" 50/50 rock & cup tooth replacement chain	253	\$3,120

TRENCHER PARTS

PART #	DESCRIPTION	WEIGHT (LBS)	PRICE
D001393	3-Point Hitch Adaptor (bolt on) Option	530	\$1,024
S1050	Hydraulic Valve Kit (for tractors with only one remote) Option	90	\$680
B2019	Idler Assembly	18	\$224

B2019 IDLER ASSEMBLY BREAKDOWN

PART #	DESCRIPTION	WEIGHT (LBS)	PRICE
B2015	Bearing 1.25	0.5	\$23
B2016	Bearing insert	0.25	\$8
B2017	Idler Pulley	15	\$103
P2037	Dirt Washer	0.25	\$9
P2034	Idler Pin	1.25	\$24
T2080	Holder Washer	0.5	\$9

CHAIN PARTS

PART #	DESCRIPTION	WEIGHT (LBS)	PRICE
C2012	Tooth RH Trencher Cup	1 Lbs	\$8
C2008	Tooth LH Trencher Cup	1 Lbs	\$8
D002332	Bullet type Rock Teeth		\$13



Skid Steer Mount Tree Spades

MODEL	Base Tree spade	AUX Connections	Wireless Hand Controls with AUX Needs 12V wire to spade	Wireless Hand Controls with 20 ft wire Needs 12V wire to spade	Electric Controls Comes with 20 ft of wire	Manual Control
X4M	Mini skid steer tree scoop	Discount on Scoop when ordered with any other product				\$720
X4C	Bobcat Mini tree scoop					\$840
X4B	*	Tree Scoop with blank weld-on plate				\$1,000
X4S	Big skid steer tree scoop	Discount on Scoop when ordered with any other product				\$1,104
ST324	24" fixed frame tree spade	\$6,632	\$6,948	\$7,392	\$7,072	\$6,112
ST330	30" fixed frame tree spade	\$7,720	\$8,036	\$8,480	\$8,160	\$7,200
SS330	30" swing blade tree spade	\$9,120	\$9,416	\$10,000	\$9,440	\$8,400
ST440	40" swing blade tree spade	\$13,156	\$12,600	\$13,280	\$12,640	\$11,476
ST650*	50" swing blade tree spade*	\$21,120	\$20,920	\$21,552	\$20,280	\$19,120
* Not priced with skid steer plate						
ACCESSORIES (Controls)					Required live pins	PRICE
E1004	Control cable, price per foot 20 ' included in price of spade					\$33
D003443	Manual Control for ST324 & ST330					\$1,320
D003444	Manual Control for SS330					\$1,560
D003445	Manual Control for ST440					\$1,996
D003446	Manual Control for ST650					\$3,160
D003427	AUX connection for ST324 & ST330				AUX 2	\$1,840
D003428	AUX connection for SS330				AUX 3	\$2,280
D003429	AUX connection for ST440				AUX 5	\$3,676
D003449	AUX connection for ST650				AUX 7	\$5,160
D001782	Electric control with 20 ft wire for ST324 & ST330				Ligher plug 1	\$2,280
D001261	Electric control with 20 ft wire for SS330				Ligher plug 1	\$2,600
D001313	Electric control with 20 ft wire for ST440				Ligher plug 1	\$3,160
D001783	Electric control with 20 ft wire for ST650				Ligher plug 1	\$4,320
D003430	Wireless hand held control with 20 ft wire, to spade, for ST324 & ST330 (need 12v to spade)				Ligher plug 1	\$2,600
D001565	Wireless hand held control with 20 ft wire, to spade, for SS330 (need 12v to spade)				Ligher plug 1	\$3,160
D001566	Wireless hand held control with 20 ft wire, to spade, for ST440 (need 12v to spade)				Ligher plug 1	\$3,800
D003447	Wireless hand held control with 20 ft wire, to spade, for ST650 (need 12v to spade)				Ligher plug 1	\$5,592
D003431	Wireless hand held control with AUX for ST324 & ST330 (need 12v to spade)				AUX 1	\$2,156
D003432	Wireless hand held control with AUX for SS330 (need 12v to spade)				AUX 1	\$2,576
D003433	Wireless hand held control with AUX for ST440 (need 12v to spade)				AUX 1	\$3,120
D003448	Wireless hand held control with AUX for ST650 (need 12v to spade)				AUX 1	\$4,960
ACCESSORIES (Out Riggers)					PRICE	
D001542	Out Rigger set for back end of skid steer (with weld-on bracket)				\$1,160	
D001567	Custom built hose kit (skid steer send in by customer for dimensioning)				\$784	
D001568	Custom built bolt-on bracket set (skid steer send in by customer for dimensioning)				\$2,040	
D001569	Extra hydraulic valve port for Out Riggers if ordered with spade				\$232	
D001570	Extra hydraulic valve port for Out Riggers if ordered later				Quote	
ACCESSORIES (Stabilizers for Root ball adjustment)					PRICE	
D001539	Spade stabilizers for root ball sizing per piece (4 hours extra labor if field installed)				\$200	



Loader Mounted Tree Spades

Add price of bolt-on loader adaptor to price of spade

**Hoses not included when ordered/shipped separately, never included in X4S, 25 ft included if ordered with spade.

ACCESSORIES included in above price			Lead time	PRICE
E1004	Code	Control cable, price per foot (25' recommended for tractors), 20' included in price of spade	stock	\$33
D001541 **	A	Flat blank bolt-on plate ideal for weld on hooks that have a smaller footprint then skid steer plate	stock	\$225
D001534 **	A	Raised blank bolt-on assembly ideal for hooks that have a larger footprint then skid steer plate	stock	\$460
D001535 **	A	ALO, Quicky loader mount, (bolts into skid steer plate) <i>must have signed drawing with order</i>	stock	\$550
D001305 **	B	Bolt on Skid steer plate (bolts onto spade)	stock	\$950
D001560 **	B	Raised blank assembly for weld-on hooks (bolts onto spade)	stock	\$560
D001561 **	B	ALO, Quicky loader mount, (bolts onto spade) <i>must have signed drawing with order</i>	1 week	\$850
10M **	A	Double list price of HLA Hooks and add cost of D001534	5-weeks	See Note
15M **	B	Double list price of HLA Hooks and add cost of D001560	5-weeks	See Note

Attach Code A has adaptors bolting into skidsteer plate which is part of the frame, can be taken off any time to be skid steer ready

Attach Code B the skid steer plate is removed and new adaptor is bolted on

Phone: 866 820 7603 E-mail: sales@baumalight.com Website www.baumalight.com
Parts and Whole Goods FOB dealer if over \$100 list, flat \$20 shipping if not (North America)
Call for quote on freight for demos or expedited shipping on warranty parts
All Tail Gate Deliveries Charged extra at \$50.00 and \$200 for delivery by appointment



3-Point Hitch Mounted Tree Spades

MODEL	Adaptor Part number	Old Model Number	SIZE 3PTH	Tractor Weight Minimum lb.	Wireless Controls With 20 wire to spade	Electric Controls Comes with 15 ft of wire	Manual Control
PT324	6M	ST324	CAT 1 ~	3000 **	\$10,512	\$10,192	\$9,232
PT330	7M	ST330	CAT 2 ~	4000 **	\$12,880	\$12,560	\$11,600
PS330	7M	SS330	CAT 2 ~	4000 **	\$14,400	\$13,840	\$12,800
PT440	7M	ST440	CAT 2 ~	6000 **	\$17,680	\$17,040	\$15,876
PT650	9M	ST650	CAT 2 ~	10,000 **	\$29,152	\$27,880	\$26,720

MODEL	Tractor requirements	Tractor Weight Minimum lb.	Wireless Controls	Electric Controls	Manual Control
X4S	Required Hydraulic Remotes with down pressure kit	NA	NA	NA	NA
ST324	Required Hydraulic Remotes with down pressure kit	3000 **	1	3 ***	1
ST330	Required Hydraulic Remotes with down pressure kit	4000 **	1	3 ***	1
SS330	Required Hydraulic Remotes with down pressure kit	4000 **	3 ***	3 ***	1
ST440	Required Hydraulic Remotes with down pressure kit	6000 **	3 ***	3 ***	1
ST650	Required Hydraulic Remotes with down pressure kit	10,000 **	NA	3 ***	1

ACCESSORIES			Down Pressure	PRICE
6M*	CAT 1, 3-point hitch plate, bolts into skidsteer plate	Add 20% if ordered /shipped separately	Yes	\$3,120
7M*	CAT 2, 3-point hitch plate, bolts into skidsteer plate	Add 20% if ordered /shipped separately	Yes	\$4,400
9M*	CAT 2, 3-point hitch frame, bolts onto spade	Add 20% if ordered /shipped separately	Yes	\$7,600

*Included in above unit price

** Purchaser must ensure adequate strength in 3-point linkage arms and tractor top link.

*** Available with less remotes with custom controls

~ Top link will have to be modified to fit tractor.



Trailer Mount Tree Spade

U60 List Price, Effective January 1, 2020

MODEL	Trailer Mounted Tree Spade For Highway use with Light Kit	Root Ball Size	Includes Light kit	Price With spade
TR330	With Self Contained Hydraulic Power Pack	30"	Yes	\$31,496
TR440	With Self Contained Hydraulic Power Pack	40"	Yes	\$34,572
TR650	With Self Contained Hydraulic Power Pack	50"	Yes	\$61,696
MODEL	Trailer Mounted Tree Spade* For Highway use with Light Kit	Root Ball Size	Includes Light kit	Price With spade
TR330	Without Hydraulic Power Pack *	30"	Yes	\$26,000
TR440	Without Hydraulic Power Pack *	40"	Yes	\$29,076
TR650	Without Hydraulic Power Pack *	50"	Yes	\$56,200

* No power pack supplied, to be used with a secondary source with auxillary hydraulic power supply

Trailer Options		
D001575	Hydraulic Power Pack	\$5,496
Trailer Models		
M22	Basic Trailer for SS330 & ST440 without Spade or Power Pack	\$17,600
M33	Basic Trailer for ST650 without Spade or Power Pack	\$37,080



Model	Base Tree Spade	Electric Controls	Early Order Discount
Skid Steer Mount Tree Spades			
HOLT34-S	34" swing, four blade tree spade	\$17,000	Extra 8% discount for 7-8 week delivery
HOLT38-S	34" swing, four blade tree spade	\$17,520	Extra 8% discount for 7-8 week delivery
HOLT44-S	34" swing, four blade tree spade	\$18,800	Extra 8% discount for 7-8 week delivery
HOLT48-S	34" swing, four blade tree spade	\$21,600	Extra 8% discount for 7-8 week delivery
HOLT50-S	34" swing, four blade tree spade	\$25,240	Extra 8% discount for 7-8 week delivery
Comes with 20ft of wire			

3 Point Hitch Tree Spades			
HOLT34P*	3 Point Hitch Adapter with HOLT34-S spade	\$19,357	Extra 8% discount for 7-8 week delivery
HOLT38P*	3 Point Hitch Adapter with HOLT38-S spade	\$19,877	Extra 8% discount for 7-8 week delivery
HOLT44P*	3 Point Hitch Adapter with HOLT44-S spade	\$22,226	Extra 8% discount for 7-8 week delivery
HOLT48P*	3 Point Hitch Adapter with HOLT48-S spade	\$25,026	Extra 8% discount for 7-8 week delivery
*Tractor must have three remotes			

Trailer Mounted Tree Spades			
HOLT34T	HOLT34-S on Road Trailer with Hydraulic Power Pack	\$40,096	Extra 8% discount for 7-8 week delivery
HOLT38T	HOLT38-S on Road Trailer with Hydraulic Power Pack	\$40,616	Extra 8% discount for 7-8 week delivery
HOLT44T	HOLT44-S on Road Trailer with Hydraulic Power Pack	\$61,376	Extra 8% discount for 7-8 week delivery
HOLT48T	HOLT48-S on Road Trailer with Hydraulic Power Pack	\$64,176	Extra 8% discount for 7-8 week delivery
HOLT50T	HOLT50-S on Road Trailer with Hydraulic Power Pack	\$67,816	Extra 8% discount for 7-8 week delivery
M22	Trailer on its own with power pack	\$23,096	Extra 8% discount for 7-8 week delivery
M33	Trailer on its own with power pack	\$42,576	Extra 8% discount for 7-8 week delivery

Eraser Stump Grinders			
HGS50F	Skid Steer Christmas Tree Stump Grinder (Fixed)	\$6,360	No extra discount for waiting
HGS60R	Skid Steer High Efficacy Stump Grinder (Swing)	\$40, See Baumalight Pricing	
HGW13	13HP Walk behind Stump Grinder	WB44, See Baumalight pricing	
HGW30	30HP Self Propelled Stump Grinder	\$18,368	Extra 8% discount for 7-8 week delivery



PTO GENERATORS - for Tractors

TX SERIES	KILOWATT	VOLTAGE	PHASE	RPM	PRICE	** EARLY ORDER DISCOUNT **
TX7	7	120/240	1	540	\$2,520	Extra 8% discount for 7-8 week delivery
TX12	12	120/240	1	540	\$2,940	Extra 8% discount for 7-8 week delivery
TX18	18.5	120/240	1	540	\$3,992	Extra 8% discount for 7-8 week delivery
TX25	25	120/240	1	540	\$4,620	Extra 8% discount for 7-8 week delivery
TX31	31	120/240	1	540	\$5,320	Extra 8% discount for 7-8 week delivery
Same as any other 2 pole Generators - TX generators do not have large motor starting capacity						
KR SERIES	KILOWATT	VOLTAGE	PHASE	RPM	PRICE	** EARLY ORDER DISCOUNT **
KR30	30	120/240	1	540	\$7,080	Extra 8% discount for 7-8 week delivery
KR44	44	120/240	1	540	\$8,960	Extra 8% discount for 7-8 week delivery
KR52	52	120/240	1	540	\$9,600	Extra 8% discount for 7-8 week delivery
KR65	65	120/240	1	540	\$11,680	Extra 8% discount for 7-8 week delivery
QC SERIES	KILOWATT	VOLTAGE	PHASE	RPM	PRICE	** EARLY ORDER DISCOUNT **
QC12	12	120/240	1	540	\$7,080	Extra 8% discount for 7-8 week delivery
QC19	19	120/240	1	540	\$7,560	Extra 8% discount for 7-8 week delivery
QC30	30	120/240	1	540	\$8,760	Extra 8% discount for 7-8 week delivery
QC45	45	120/240	1	540	\$11,000	Extra 8% discount for 7-8 week delivery
QC55	55	120/240	1	540	\$12,464	Extra 8% discount for 7-8 week delivery
QC65	65	120/240	1	540	\$13,440	Extra 8% discount for 7-8 week delivery
QC80	80	120/240	1	1000	\$14,960	Extra 8% discount for 7-8 week delivery
QC100	100	120/240	1	1000	\$16,400	Extra 8% discount for 7-8 week delivery
QC30-2	30	120/208	3	540	\$9,440	Extra 8% discount for 7-8 week delivery
QC45-2	45	120/208	3	540	\$11,360	Extra 8% discount for 7-8 week delivery
QC68-2	68	120/208	3	540	\$13,520	Extra 8% discount for 7-8 week delivery
QC105-2	105	120/208	3	1000	\$16,000	Extra 8% discount for 7-8 week delivery
QC30-3	30	120/240	3	540	\$9,520	Extra 8% discount for 7-8 week delivery
QC45-3	45	120/240	3	540	\$11,440	Extra 8% discount for 7-8 week delivery
QC68-3	68	120/240	3	540	\$13,560	Extra 8% discount for 7-8 week delivery
QC105-3	105	120/240	3	1000	\$16,080	Extra 8% discount for 7-8 week delivery
QC30-4	30	277/480	3	540	\$9,360	Extra 8% discount for 7-8 week delivery
QC45-4	45	277/480	3	540	\$11,200	Extra 8% discount for 7-8 week delivery
QC68-4	68	277/480	3	540	\$13,440	Extra 8% discount for 7-8 week delivery
QC105-4	105	277/480	3	1000	\$15,840	Extra 8% discount for 7-8 week delivery
QC27-6	27	377/600	3	540	\$8,320	Extra 8% discount for 7-8 week delivery
QC50-6	50	377/600	3	540	\$10,800	Extra 8% discount for 7-8 week delivery
QC75-6	75	377/600	3	1000	\$12,920	Extra 8% discount for 7-8 week delivery
QC100-6	100	377/600	3	1000	\$16,240	Extra 8% discount for 7-8 week delivery

IMPORTANT: All unit prices for both series include trailer, PTO shaft, and 10' cord with Anderson Connectors



PTO GENERATOR ACCESSORIES

TRAILERS (included in Generator Prices)					PRICE
G2000	Trailer TX7 & TX12				\$236
G2079	Trailer for TX18, TX25, TX31, QC 12, QC19, QC30				\$308
G2078	Trailer 45KW to 105 KW				\$440
D001478	Vibro-Isolator to mount a generator on a cement pad (x4 for a set)				\$60
D001371	3-Point Hitch Deck TX7 & TX12				\$440
D001378	3-Point Hitch Deck for TX18, TX25, TX31, QC 12, QC19, QC30, QC45				\$600
D001434	3-Point Hitch Deck 55KW to 105 KW				\$796
G2107	Jack (not included in main price)				\$132
\$50 Disassembly charge for shaft or cord removed from crated models					
\$150 Disassembly charge to remove trailer from crated models (includes removal of any other items)					
PTO SHAFTS (included in Generator Price)					PRICE
G2002	Generators 7KW to 12 KW		540 RPM		\$96
G2011	Generators 18KW to 31 KW		540 RPM		\$128
G2082	Generators 45 KW		540 RPM		\$232
G2083	Generators 55Kw to 75 KW		540 RPM		\$336
G2084	Generators 65Kw to 105 KW		1000 RPM		\$384
\$50 Disassembly charge for shaft or cord removed from crated models					
ELECTRIC CABLE (10' wire kit included in Unit Price)					PRICE
D001795	7 KW	#8/4	Needs 1 strand	Per Foot	\$6
E2009	12 KW	#6/4	Needs 1 strand	Per Foot	\$10
E2011	18-31 KW	#4	Needs 3 strands	Per Foot	\$3
E1005	45 KW	#2	Needs 3 strands	Per Foot	\$5
E2023	55-68 KW	2/0	Needs 3 strands	Per Foot	\$7
E2035	80-105 KW	4/0	Needs 3 strands	Per Foot	\$12
Three Phase applications need 4 strands of wire					
\$50 Disassembly charge for shaft or cord removed from crated models					
SPARE CABLE END PLUGS (One set included in Generator Price)					PRICE
E2007	50 AMP	4 pole male Range Plug			\$60
E1000	175 AMP	Complete Anderson Plug with four #2 pins and handle			\$42
E1001	175 AMP	Complete Anderson Plug with four #4 pins and handle			\$42
E1002	350 AMP	Complete Anderson Plug with four 2/0 pins and handle			\$62
E1003	350 AMP	Complete Anderson Plug with four 4/0 pins and handle			\$62



Screw Splitter and Screw Planer

New Model	Carrier Weight (Max.)		Rec. GPM to Max. GPM(Full Load)	Recommended PSI	Drive Size	Drive Type	Price
	Planer	Splitter					
Universal Skid Steer mount splinter drive							
RSS380	5000 Lbs	7000 lbs	20-40 to Max.45	2,500-3,000 Max.3,300	2" Hex	Planetary	\$4,688
RSS580	7000 Lbs	9000 lbs	20-45 to Max.45	2,500-3,000 Max.3,300	2" Hex	Planetary	\$4,960
RSS780	11,000 Lbs	12000 lbs	20-55 to Max.65	2,500-4,500 Max.5,000	8 Bolt Flange	Heavy Duty Planetary	\$8,640
Bolt on Excavator mount splinter drive							
RSX380	3 ton	5 ton	20-40 to Max.45	2,500-3,000 Max.3,300	2" Hex	Planetary	\$4,480
RSX580	8 ton	12 ton	20-45 to Max.45	2,500-3,000 Max.3,300	2" Hex	Planetary	\$4,784
RSX780	12 ton	16 ton	20-55 to Max.65	2,500-4,500 Max.5,000	8 Bolt Flange	Heavy Duty Planetary	\$8,400

Hoses included for skidsteer model only but no couplers

Splinter Tools		Price
D002507	Complete 2" Hex 14x8 splitter cone assembly	\$960
D004919	2" Hex Splitter Cone Top Flange bolt-on replacement Assembly	\$160
D003935	Complete 8-bolt flange mount 14x8 splitter cone assembly	\$1,040
D003944	8-bolt flange stand-off	\$256
D003722	Replacement large top half of splinter cone for both 2" hex and flange drive	\$552
D002506	Splinter Tip - Hardened 4140 40/45RC for D002507 & D003935	\$312

Planer Tools		Price
D002771	2" Hex 20" dia. 4-knife stump planer	\$1,000
D003381	8-bolt flange mount stump planer	\$1,480
D003508	Planer Spiral Tip - 4140 40/45RC for D002771 & D003381	\$280
D003930	Small blade assembly for D002771 Planer	\$360
D003434	Small Blade Assembly for D003381 Planer	\$440

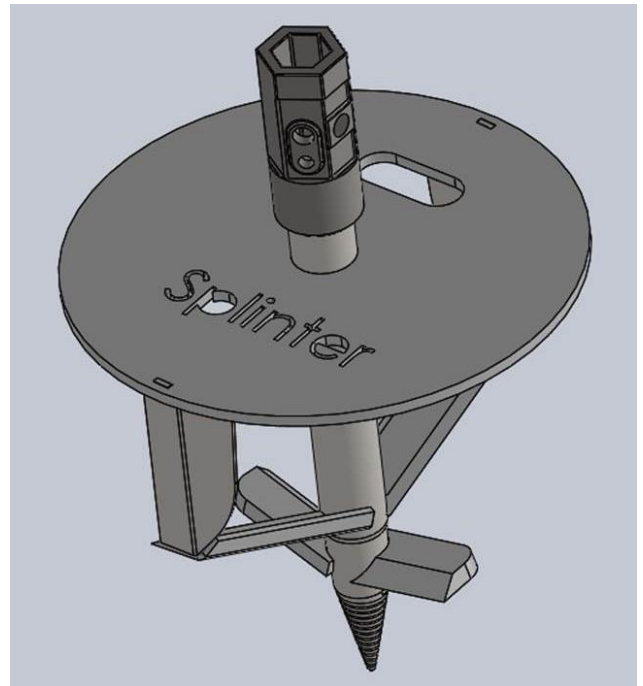



Tree Shear - Skidsteer

Model	Carrier	Weight Class	Limb Size	Type	Grabber	Number of blades	Blade Thickness	GPM	PSI	Hoses and Couplers	Price
ISH3M	Mini Skid Steer	1,500 - 4,000 lbs	2"	Horizontal	Yes	Tree Puller		5-40 gpm	2,500-4,500	Included	\$1,516
ISH3P	Skid Steer	4,000 - 8,000 lbs	2"	Horizontal	Yes	Tree Puller		5-40 gpm	2,500-4,500	Included	\$1,720
ISH508	Skid Steer	3,000 -6,000 lbs	8"	Horizontal	No	1	1/2"	5-40 gpm	2,500-4,500	Included	\$3,000
ISH510	Skid Steer	4,000 - 7,000 lbs	10"	Horizontal	No	1	1"	10-50 gpm	2,500-4,500	Included	\$3,996
ISH512	Skid Steer	5,000 - 8,000 lbs	12"	Horizontal	No	1	1"	15-60 gpm	2,500-4,500	Included	\$4,200
ISR508	Skid Steer	3,000 -6,000 lbs	8"	Rotating	No	1	1/2"	5-40 gpm	2,500-4,500	Included	\$5,400
ISR510	Skid Steer	4,000 - 7,000 lbs	10"	Rotating	No	1	1"	10-50 gpm	2,500-4,500	Included	\$5,800
ISR512	Skid Steer	5,000 - 8,000 lbs	12"	Rotating	No	1	1"	15-60 gpm	2,500-4,500	Included	\$6,280
ISH508G	Skid Steer	3,000 -6,000 lbs	8"	Horizontal	Yes	1	1/2"	5-40 gpm	2,500-4,500	Included	\$4,120
ISH510G	Skid Steer	4,000 - 7,000 lbs	10"	Horizontal	Yes	1	1"	10-50 gpm	2,500-4,500	Included	\$4,680
ISH512G	Skid Steer	5,000 - 8,000 lbs	12"	Horizontal	Yes	1	1"	15-60 gpm	2,500-4,500	Included	\$5,080
ISH610	Skid Steer	4,000 - 7,000 lbs	10"	Low cut	No	2	1/2"	10-50 gpm	2,500-4,500	Included	\$4,368
ISH610G	Skid Steer	4,000 - 7,000 lbs	10"	Low cut	Yes	2	1/2"	10-50 gpm	2,500-4,500	Included	\$5,960
ISH612	Skid Steer	5,000 - 8,000 lbs	12"	Low cut	No	2	1/2"	15-60 gpm	2,500-4,500	Included	\$5,720
ISH612G	Skid Steer	5,000 - 8,000 lbs	12"	Low cut	Yes	2	1/2"	15-60 gpm	2,500-4,500	Included	\$6,720
ISH712G	Skid Steer	6,000 - 12,000 lbs	12"	Low cut	Yes	2	1/2"	15-60 gpm	2,500-4,500	Included	\$10,360
ISH715G	Skid Steer	5,000 - 8,000 lbs	15"	Low cut	Yes	2	1/2"	15-60 gpm	2,500-4,500	Included	Quote
ISV508	Skid Steer	3,000 -6,000 lbs	8"	Vertical	No	1	1/2"	5-40 gpm	2,500-4,500	Included	\$2,800
ISV510	Skid Steer	4,000 - 7,000 lbs	10"	Vertical	No	1	1"	10-50 gpm	2,500-4,500	Included	\$3,600
ISV512	Skid Steer	5,000 - 8,000 lbs	12"	Vertical	No	1	1"	15-60 gpm	2,500-4,500	Included	\$4,120

Tree Shear - Excavator

See Brush Mulcher section for Adaptor pricing

IXV508	Excavator	3 -10 ton	8"	Vertical	No	1	1/2"	5-40 gpm	2,500-4,500	None Needed	\$3,600
IXV510	Excavator	5 -15 ton	10"	Vertical	No	1	1"	10-50 gpm	2,500-4,500		\$5,240
IXV512	Excavator	8 -20 ton	12"	Vertical	No	1	1"	15-60 gpm	2,500-4,500		\$6,040
IXV715	Excavator	15 -26 ton	15"	Vertical	No	1	1"	20-100 gpm	2,500-4,500		\$7,960
IXP308G	Excavator	3 -10 ton	8"	Pivoting	Yes	1	1/2"	5-40 gpm	2,500-4,500	Not included	\$5,800
IXP510G	Excavator	5 -15 ton	10"	Pivoting	Yes	1	1"	10-50 gpm	2,500-4,500	Not included	\$6,680
IXP512G	Excavator	8 -20 ton	12"	Pivoting	Yes	1	1"	15-60 gpm	2,500-4,500	Not included	\$7,080
IXP715G	Excavator	15 -26 ton	15"	Pivoting	Yes	2	1"	20-100 gpm	2,500-4,500	Not included	\$9,800
IXH308	Excavator	3 -10 ton	8"	Horizontal	No	1	1/2"	5-40 gpm	2,500-4,500	Not included	\$4,360
IXH510	Excavator	5 -15 ton	10"	Horizontal	No	1	1"	10-50 gpm	2,500-4,500	Not included	\$5,200
IXH512	Excavator	8 -20 ton	12"	Horizontal	No	1	1"	15-60 gpm	2,500-4,500	Not included	\$6,040
IXH715	Excavator	15 -26 ton	15"	Horizontal	No	2	1"	20-100 gpm	2,500-4,500	Not included	\$8,760
IXH308G	Excavator	3 -10 ton	8"	Horizontal	Yes	1	1/2"	5-40 gpm	2,500-4,500	Not included	\$5,200
IXH510G	Excavator	5 -15 ton	10"	Horizontal	Yes	1	1"	10-50 gpm	2,500-4,500	Not included	\$6,280
IXH512G	Excavator	8 -20 ton	12"	Horizontal	Yes	1	1"	15-60 gpm	2,500-4,500	Not included	\$6,600
IXH715G	Excavator	15 -26 ton	15"	Horizontal	Yes	2	1"	20-100 gpm	2,500-4,500	Not included	\$8,800
IXA508G	Excavator	3-10 ton	15"	Actuator	Yes	2	1/2"	20-100 gpm	2,500-4,500	Not included	\$12,200
IXA512G	Excavator	8 -20 ton	15"	Actuator	Yes	2	1/2"	20-100 gpm	2,500-4,500	Not included	\$15,600
IXA715G	Excavator	15 -26 ton	15"	Actuator	Yes	2	1/2"	20-100 gpm	2,500-4,500	Not included	\$18,000



Tree Saw

New Model	Blade	Blade Angle	Requires Case Drain	Hydraulic Hose	Hydraulic Couplers	Motor Type	Motor Option	Price*
Mini Skid Steer Tree Saw								
DSM230	30" dia. blade	Manual Rotation	Yes	Supplied	Not Supplied	Gear	T508G	\$ 4,240
	30" dia. blade	Manual Rotation	Yes	Supplied	Not Supplied	Bent Axis Piston	T508	\$ 5,480
Skid Steer Tree Saw								
DSM530	30" dia. blade	Manual Rotation	Yes	Supplied	Not Supplied	Gear	T508G	\$ 5,080
	30" dia. blade	Manual Rotation	Yes	Supplied	Not Supplied	Bent Axis Piston	T508	\$ 6,320
	30" dia. blade	Manual Rotation	Yes	Supplied	Not Supplied	Gear	T530G	\$ 5,220
	30" dia. blade	Manual Rotation	Yes	Supplied	Not Supplied	Bent Axis Piston	T530	\$ 7,040
Skid Steer Tree Saw								
DSA530	30" dia. blade	180 degrees / Actuator	Yes	Supplied	Not Supplied	Gear	T508G	\$ 9,760
	30" dia. blade	180 degrees / Actuator	Yes	Supplied	Not Supplied	Bent Axis Piston	T508	\$ 11,000
	30" dia. blade	180 degrees / Actuator	Yes	Supplied	Not Supplied	Gear	T530G	\$ 9,900
	30" dia. blade	180 degrees / Actuator	Yes	Supplied	Not Supplied	Bent Axis Piston	T530	\$ 11,720
Excavator Tree Saw								
DXM530	30" dia. blade	Manual Rotation	Yes	Not Supplied	Not Supplied	Gear	T508G	\$ 4,240
	30" dia. blade	Manual Rotation	Yes	Not Supplied	Not Supplied	Bent Axis Piston	T508	\$ 5,480
	30" dia. blade	Manual Rotation	Yes	Not Supplied	Not Supplied	Gear	T530G	\$ 4,380
	30" dia. blade	Manual Rotation	Yes	Not Supplied	Not Supplied	Bent Axis Piston	T530	\$ 6,200
Excavator Tree Saw								
DXA530	30" dia. blade	180 degrees / Actuator	Yes	Not Supplied	Not Supplied	Gear	T508G	\$ 8,920
	30" dia. blade	180 degrees / Actuator	Yes	Not Supplied	Not Supplied	Bent Axis Piston	T508	\$ 10,160
	30" dia. blade	180 degrees / Actuator	Yes	Not Supplied	Not Supplied	Gear	T530G	\$ 9,060
	30" dia. blade	180 degrees / Actuator	Yes	Not Supplied	Not Supplied	Bent Axis Piston	T530	\$ 10,880
Excavator Tree Saw								
DXH752	52" dia. blade	Fixed Horizontal	Yes	Not Supplied	Not Supplied	Bent Axis Piston	T550	\$ 18,360
	52" dia. blade	Fixed Horizontal	Yes	Not Supplied	Not Supplied	Bent Axis Piston	T570	\$ 19,280
	52" dia. blade	Fixed Horizontal	Yes	Not Supplied	Not Supplied	Bent Axis Piston	T590	\$ 20,160
Tractor 3-point Hitch Tree Saw								
DPH530	30" dia. blade	Fixed Horizontal	No	Not required	540 RPM	Slip Clutch	CAT 1	\$ 4,792
Tractor 3-point Hitch Tree Saw								
DPH735	35" dia. blade	Fixed Horizontal	No	Not required	540 RPM	Slip Clutch	CAT 2	\$ 7,040

* Need to add price of excavator adaptor

See teeth price page in the back for tooth & accessory prices



Feller Buncher

New Model	Required live pins	Blade Angle	Requires Case Drain	Hydraulic Hose	Hydraulic Couplers	Motor Type	Motor Option	Price
Skidsteer								
FBS752	4 hot on AUX *	Fixed Horizontal	Yes	Supplied	Not Supplied	Bent Axis Piston	T570	\$ 23,840
	4 hot on AUX *	Fixed Horizontal	Yes	Supplied	Not Supplied	Bent Axis Piston	T590	\$ 25,200
Excavator								
FBH752	4 hot on AUX ~	Fixed Horizontal	Yes	Not Supplied	Not Supplied	Bent Axis Piston	T570	\$ 25,440
	4 hot on AUX ~	Fixed Horizontal	Yes	Not Supplied	Not Supplied	Bent Axis Piston	T590	\$ 26,800
Excavator								
FBXP752	4 hot on AUX ~	90 Degree Pivot	Yes	Not Supplied	Not Supplied	Bent Axis Piston	T570	\$ 27,040
	4 hot on AUX ~	90 Degree Pivot	Yes	Not Supplied	Not Supplied	Bent Axis Piston	T590	\$ 28,400
Excavator								
FBXD752	4 hot on AUX ~	180 Degree Slew Drive	Yes	Not Supplied	Not Supplied	Bent Axis Piston	T570	\$ 30,240
	4 hot on AUX ~	180 Degree Slew Drive	Yes	Not Supplied	Not Supplied	Bent Axis Piston	T590	\$ 31,600

Need to add price of excavator adaptor to price

* Wire with plug supplied to AUX on boom

~ No wire or plug supplied, the below control & plug can be ordered but we don't supply wires to run along excavator booms

Accessories

	Description	Plug style	Price
D004956	Plug into 14 pin plug on FBS752 - Run a wire through your door and have a control box on your lap	14 pin	\$ 380

See teeth price page for tooth pricing





Rotary Brush Mowers

300 series

Model	Recommended G.P.M. (Ideal)	Maximum GPM*	Number of Blades	Requires Case Drain	Hydraulic Hose & Couplers	Motor Options	Price
Skid Steer Brush Cutt - 70" Path Width, 60" Blade Width							
CF360	12-20	20 GPM*	2	No	Included	M450	\$6,040
	12-25	26 GPM*	2	Yes **	Hose only	M550	\$6,400
	22-40	42 GPM*	2	Yes	Hose only	M650	\$7,352
Skid Steer Brush Cutt - 82" Path Width, 72" Blade Width							
CF372	12-20	20 GPM*	2	No	Included	M450	\$7,080
	12-25	26 GPM*	2	Yes **	Hose only	M550	\$7,440
	22-40	42 GPM*	2	Yes	Hose only	M650	\$8,392

500 series

Skid Steer Brush Cutt - 70" Path Width, 60" Blade Width - open front							
CF560	12-20	20 GPM*	4	No	Included	M450	\$6,920
	12-25	26 GPM*	4	Yes **	Hose only	M550	\$7,280
	22-40	42 GPM*	4	Yes	Hose only	M650	\$8,232
Skid Steer Brush Cutt - 82" Path Width, 72" Blade Width - open front							
CF572	12-20	20 GPM*	4	No	Included	M450	\$7,320
	12-25	26 GPM*	4	Yes **	Hose only	M550	\$7,680
	22-40	42 GPM*	4	Yes	Hose only	M650	\$8,632

700 series

Skid Steer Disk Mulcher - 55" Path Width, 44" Rotor Width							
CSC744	12 - 22	24 GPM*	Solid disk	Critical	Hose only	HS430	\$18,800
	18 - 30	33 GPM*	Solid disk	Critical	Hose only	HS450	\$19,200
	25 - 45	50 GPM*	Solid disk	Critical	Hose only	HS490	\$21,200
Skid Steer Disk Mulcher - 70" Path Width, 60" Rotor Width							
CSC760	25 - 42	45 GPM*	Solid disk	Critical	Hose only	Fixed	\$26,800

* NOTICE this value is the full load GPM rating

** Not required for bottom GPM range



Rotary Brush Mowers

3-Point Hitch

Model	Description	Number of Blades	PTO RPM	Hydraulic Hose/Couplers	Price
PTO Drive 3-point Hitch Brush Mulcher - 70" Path Width, 60" Blade Width					
CP560	45-70 HP CAT 2	4	540 rpm	Not needed	\$5,440
PTO Drive 3-point Hitch Brush Mulcher - 82" Path Width, 72" Blade Width					
CP572	50-80 HP CAT 2	4	540 rpm	Not needed	\$6,240

Excavator mount

Model	Recommended G.P.M. (Ideal)	Maximum GPM*	Number of Blades	Requires Case Drain	Hydraulic Hose & Couplers	Motor Options	Price
Excavator Disk Mulcher - 40" Path Width, 30" Rotor Width							
CXC530	8 - 14	16 GPM	3	Critical	Not supplied	HX508	\$8,400
	12 - 20	22 GPM	3	Critical	Not supplied	HX510	\$8,720
	15 - 26	28 GPM	3	Critical	Not supplied	HX530	\$8,960
Excavator Disk Mulcher - 55" Path Width, 42" Rotor Width							
CXC542	See Catalog		3	Critical	Not supplied	HX530	\$10,960
	See Catalog		3	Critical	Not supplied	HX550	\$11,080
	See Catalog		3	Critical	Not supplied	HX570	\$11,920
Excavator Disk Mulcher - 67" Path Width, 50" Rotor Width							
CXC550	See Catalog		3	Critical	Not supplied	HX530	\$11,920
	See Catalog		3	Critical	Not supplied	HX550	\$12,040
	See Catalog		3	Critical	Not supplied	HX570	\$12,880
	See Catalog		3	Critical	Not supplied	HX590	\$13,680
See Mulcher section for Mounting Adaptors and Options, they are interchangeable							

Accessories	Carrier	Class/Model	Price	
D001041	CF Brush Cutt Swing Blade (per pc)	Skidsteer & 3-Point Hitch	CF	\$34.80
D001275	1" Castle Nut for Swing Blade	Skidsteer & 3-Point Hitch	CF	\$4.80
D001276	1" Blade bolt with Cross hole for Swing blade	Skidsteer & 3-Point Hitch	CF	\$12.80
D001779	1" hardened washer for swing blade	Skidsteer & 3-Point Hitch	CF	\$1.60
D001866	Cotter Pin for swing blade Bolt	Skidsteer, 3-Point Hitch & Excavator	CF	\$1.60
D003970	CXC530 Swing Blade	Excavator	CXC530	\$28.40
D004325	CXC542 Swing Blade	Excavator	CXC542	\$28.40
D003014	CXC550 Swing Blade	Excavator	CXC550	\$42.00
D002543	1" Step Bolt for Swing Blade	Excavator	500	\$35.60
D003397	1" Nut for Step bolt	Excavator	500	\$18.00
See Mulcher section for 700 series Disk Mulcher teeth & Accessories			CSC	



Boom Mower - Skidsteer

Model	Reach when flat	Head width	Boom Type	Type of Blades	Minimum carrier weight	Recommended G.P.M. (Ideal)	Maximum GPM*	Requires Case Drain	Hydraulic Hose & Couplers	Motor type	Motor Options	Price*
SWA540	6 ft	48"	Single Arm	Flail	4,500	19-26	28 GPM	Yes	Hose only	Gear	D510G	\$10,800
						25-33	35 GPM	Yes	Hose only	Gear	D530G	\$10,960
						19-26	28 GPM	Yes	Hose only	Piston	D510	\$11,520
						25-33	35 GPM	Yes	Hose only	Piston	D530	\$11,920
SWA550	7 ft	60"	Single Arm	Flail	5,000	19-26	28 GPM	Yes	Hose only	Gear	D510G	\$11,040
						25-33	35 GPM	Yes	Hose only	Gear	D530G	\$11,200
						19-26	28 GPM	Yes	Hose only	Piston	D510	\$11,760
						25-33	35 GPM	Yes	Hose only	Piston	D530	\$12,160
SWA560	10 ft	60"	Single Arm	Flail	5,500	19-26	28 GPM	Yes	Hose only	Gear	D510G	\$11,520
						25-33	35 GPM	Yes	Hose only	Gear	D530G	\$11,680
						19-26	28 GPM	Yes	Hose only	Piston	D510	\$12,240
						25-33	35 GPM	Yes	Hose only	Piston	D530	\$12,640
SWA750	7 ft	42"	Single Arm	Rotary cutter	8,000	25-33	35 GPM	Yes	Hose only	Piston	HX550	\$16,400
						30-40	42 GPM	Yes	Hose only	Piston	HX570	\$16,680
SWF560	10 ft	48"	Boom & Stick	Flail	6,000	19-26	28 GPM	Yes	Hose only	Gear	D510G	\$12,480
						25-33	35 GPM	Yes	Hose only	Gear	D530G	\$12,640
						19-26	28 GPM	Yes	Hose only	Piston	D510	\$13,200
						25-33	35 GPM	Yes	Hose only	Piston	D530	\$13,600
SWF580	14 ft	48"	Boom & Stick	Flail	8,000 lbs	19-26	28 GPM	Yes	Hose only	Gear	D510G	\$14,040
						25-33	35 GPM	Yes	Hose only	Gear	D530G	\$14,200
						19-26	28 GPM	Yes	Hose only	Piston	D510	\$14,760
						25-33	35 GPM	Yes	Hose only	Piston	D530	\$15,160

* Priced without controls

Will consider to build anything requested

Control options Must be priced extra

Boom Class	Number of Cylinders	Control Description	Required live AUX pins on boom	Control Part number	Price
SWA	2	** Best option - use buttons built right into joy sticks in skidsteer	4 live	D004904	\$1,120
		** Second Best option - use joy sticks buttons - requirement to hold two for some functions	3 live	D004905	\$1,200
		Plug into D004904 and have a control box on your lap - D004904 also required	Plug into 12V in Cab	D004906	\$360
		~Plug into D004905 and have a control box on your lap - D004905 also required	Plug into 12V in Cab	D004907	\$384
SWF	3	** Best option - use buttons built right into joy sticks in skidsteer	6 live	D004908	\$1,480
		** Second Best option - use joy sticks buttons - requirement to hold two for some functions	4 live	D004909	\$1,640
		Plug into D004908 and have a control box on your lap - D004908 also required	Plug into 12V in Cab	D004910	\$400
		~Plug into D004909 and have a control box on your lap - D004909 also required	Plug into 12V in Cab	D004911	\$480

** Add \$500 if field installed

~ Operation for this option will be difficult



Drainage Plow

Model	Description	Depth	Tile size	Required remotes	Price ***	8Week8%
3-point Hitch Drainage Plow for 15,000 to 30,000 lb tractor						
UPP748	CAT 3 3-Point Hitch	4'	4"	2*	\$23,160	\$21,307
	UPP748 shipping skid	Required if shipped in a van trailer		D003968	\$760	\$699
<i>As of Jan 1 2021 Trailer plows and accessories no longer offered with free freight</i>						
3-point Hitch Drainage Plow for 20,000 to 45,000 lb tractor						
UPP760	CAT 4 3-Point Hitch	5'	4" & 6"	2*	\$29,000	\$26,680
	UPP760 shipping skid	Required if shipped in a van trailer		D003795	\$1,400	\$1,288
<i>As of Jan 1 2021 Trailer plows and accessories no longer offered with free freight</i>						
Pull Type Drainage Plow for 25,000 to 50,000 lb tractor						
UPT760	Pull Type	5'	4" & 6"	2*	\$33,600	\$30,912
						<i>Priced without PowerPack</i>
<i>Must be loaded on a low deck truck or towed - As of Jan 1 2021 Trailer plows and accessories no longer offered with free freight</i>						

- * Add extra for power feeder
- ** Add extra for power table turner
- *** Freight extra
- ~ On Plows only

**Free in-field training from Dealer or Territory manager or
\$1,000 (list) credit on purchase~**

Tile Stringer

Model	G.P.M.			Hydraulic Hose & Couplers	Price ***	8Week8%
Trail type tile stringer						
UST510	5-15			1**	\$7,880	\$7,250
	UST510 stringer shipping skid	Required if shipped in a van trailer		D003635	\$920	\$846
<i>As of Jan 1 2021 Trailer plows and accessories no longer offered with free freight</i>						

Accessories					Price ***
D003644	Power Tile feeder				\$1,596
D003624	Power Table turner				\$1,440
D003681	Tripod for laser 3.8M Fiberglass				\$680
D004058	Power pack for Trailer Plow				\$4,400
<i>As of Jan 1 2021 Trailer plows and accessories no longer offered with free freight</i>					



BAUMALIGHT.COM/AUX

AUXILIARY ELECTRICAL CONNECTION

Connecting equipment can be confusing, difficult and time consuming especially when the attachment has more than one Hydraulic function.

All you want to do, is get down to work.

Baumalight now offers a more direct and simple way of connecting.

The Baumalight Auxiliary Electrical Connection. We can now connect to your skidsteer's auxiliary electrical connection.

So connection is as easy as connecting the hydraulics and plugging in the electrical.

Now you can control the attachment with the controls in your cab.





Getting ready for quick hook-ups and less cab clutter is easy. Let us know the make and model of your skidsteer and we will configure it so it is ready to go.

Single Skidsteers

Getting set up is extremely easy. Once you have picked your attachment, let your dealer know you want the Baumalight Aux Electrical Connection, then let us know the make and model of your skidsteer and we'll configure the connection for your individual skidsteer - for immediate plug and play operation.



Multiple Skidsteers

If you have multiple skidsteers of different makes and models, they may need different pin configurations.



We have adapter plugs to solve the problem. Let us know at the time of ordering that you want one or more adapters along with the make and model they are for and we will configure them for you. Baumalight adapter plugs will let you enjoy the convenience of operating multiple attachments with multiple skidsteers.

Pin Tool

Every Baumalight Aux Electrical Connection ships with a blue pin tool. With this tool you can re-configure the Aux connection to another skidsteer pin configuration. This allows you to change your connection to match a new skidsteer model



Retro Fit Attachments

We can also retro fit your existing Baumalight attachments to work with the Aux Electrical Connection. Pricing varies depending on age and current set up, so call for details and we will walk you through the process.



Older Skid Steers

Is one of your skidsteers older, without an auxiliary electrical connection?

We also have an in-cab adapter to plug into your Aux Electrical Connected attachments that will allow you to run them. Plug the adapter into the attachment, connect it to 12V and now you can run your new attachment on an older skidsteer.





AUX Parts Pricing



U60 List price 2021

Part number	Item	Configuration	Mount Location	Description	Cost
D002570	Plug	14 pin	Attachment	PLUG ASM HD36-18-14SN-059 14 pin LADD AUX	\$ 60.00
D002572	FM pin	14 pin	Attachment	CONT SOC ASM 0462-201-16141 LADD (for 14 pin plugs) AUX	\$ 1.20
D002571	Receptacle	14 pin	Skid Steer	RECP ASM HD34-18-14PN-059 14 pin LADD AUX	\$ 76.00
D002573	pin	14 pin	Skid Steer	CONT PIN 0460-202-16141 LADD (for 14 pin plugs) AUX	\$ 1.06
D002613	Plug	8 pin	Attachment	PLUG ASM HD36-18-8SN-059 LADD (8 pin) AUX	\$ 61.60
D002614	FM pin	8 pin	Attachment	CONT SOC ASM 0462-203-12141 for HD36-18-8SN-059 (8 pin) AUX	\$ 2.00
D002702	Tool	all	Attachment	Removal tool 0411-204-1605 AUX	\$ 4.80
E1004	Wire	16 wire	Attachment	Wire 16/16 (88516) supertrex AUX	\$ 32.00
E2068	Wire	3 wire	Attachment	Wire 16/3 (87193) supertrex AUX	\$ 16.00
D003029	Wire	7 wire	Attachment	Wire 16/7 (88507B) supertrex AUX	\$ 24.00
D003036	adaptor	14 pin	Attachment	Cheater adaptor 14 pin AUX (16 wire)	\$ -
D003039	adaptor	8 pin	Attachment	Cheater adaptor 8 pin AUX (16 wire)	\$ -
D003075	Nut		Skid Steer	Panel Nut for Plug	\$ -
D003095	Washer		Skid Steer	Lock Washer for Plug	\$ -
D002797	Plug	2 pin	Valve	S24 & Martatch valve	\$ 2.24

Part number	Item	Configuration	Mount Location	Description	Price
D002597	Valve	Selector	Attachment	12V 6-port selector valve 23 GPM 8 ORB Nimco AUX	\$ 434.40

First valve gives two selectable circuits and needs one activating wire
Each additional valve add one addition circuit and needs one activating wire per valve
Ideal for cylinder use only with no motors involved as only one circuit can be activated
Selector valves come with manifold bodies and can be bolted together

D001266	Valve	Directional	Attachment	12V Comatrol D03 Directional Control Valve	\$ 120.00
D002703	Valve	Directional	Attachment	24V Comatrol D03 Directional Control Valve	\$ 144.00

Each valve gives one directional circuit and needs to activating wires
Hydraulic circuit from skidsteer can be always on and multiple functions be operated simintanusly
A D03 directional valve must be ordered with a matching manifold below

H2000	Manifold	D03	Attachment	1 Bank valve block for electric valve (D03 Manifold w/ relief valve)	\$ 186.40
D001607	Manifold	D03	Attachment	2 Bank valve block for electric valve (D03 Manifold w/ relief valve)	\$ 154.40
D001608	Manifold	D03	Attachment	3 Bank valve block for electric valve (D03 Manifold w/ relief valve)	\$ 176.00
D001265	Manifold	D03	Attachment	4 Bank valve block for electric valve (D03 Manifold w/ relief valve)	\$ 200.00
D002704	Manifold	D03	Attachment	5 bank valve block for electric valve (D03 manifold w/ relief valve)	\$ 232.00
D001311	Manifold	D03	Attachment	6 Bank valve block for electric valve (D03 Manifold w/ relief valve)	\$ 320.00
D001609	Manifold	D03	Attachment	7 Bank valve block for electric valve (D03 Manifold w/ relief valve)	\$ 500.00
D001610	Manifold	D03	Attachment	8 Bank valve block for electric valve (D03 Manifold w/ relief valve)	\$ 528.00

Freight included in price of parts



Blank Weld-on Options (Bolts to Frames)			
D001161	Blank Weld-On Plate for 1.5T to 10T Excavator - without bolts	Stocked	\$ 96.00
D004951	Set of 10 5/8" x 2" G5 bolts with lock nuts - Free if mount ordered with whole good	Stocked	\$ 56.00
D001419	Blank Weld-On Plate for 8T to 25T Excavator - without bolts	Stocked	\$ 160.00
D004952	Set of 26 5/8" x 2" G5 bolts with lock nuts - Free if mount ordered with whole good	Stocked	\$ 145.60

Turn Key Mounting Adaptor Options (Bolts to Frames) Bolts not included if ordered separately 50% of list price for a set of ears only							
Manufactured by	Carrier	Class	Ton	Approx.	Wedge Price~	Pin-On/Pin Grabber Price ~ **	Cross Pin Price ~
Baumalight *	Excavator	5	1.5 to 3	80 Lbs.	\$ 462.00	\$ 714.00	\$ 928.20
Baumalight *	Excavator	5	3 to 6	100 Lbs.	\$ 630.00	\$ 831.60	\$ 1,081.08
Baumalight *	Excavator	8	7 to 9	200 Lbs.	\$ 798.00	\$ 915.60	\$ 1,190.28
Baumalight *	Excavator	10	10 to 11	225 Lbs.	\$ 1,008.00	\$ 1,142.40	\$ 1,485.12
Baumalight *	Excavator	13	12 to 15	250 Lbs.	\$ 1,176.00	\$ 1,327.20	\$ 1,725.36
Baumalight *	Excavator	15	16 to 19	275 Lbs.	\$ 1,344.00	\$ 1,453.20	\$ 1,889.16
Baumalight *	Excavator	20	20 to 22	300 Lbs.	\$ 1,512.00	\$ 1,646.40	\$ 2,140.32
Baumalight *	Excavator	25	23 to 29	325 Lbs.	\$ 1,596.00	\$ 1,722.00	\$ 2,238.60
Baumalight *	Excavator		Over 30	400 Lbs.	Quote	Quote	Quote

*Use part number D001784 when ordering for excavator model not listed on SuddenShipping.com and indicate Class and Adaptor Style

~ Bolts not included if ordered separately - See blank weld-on section above for prices on bolts

**Pins Not Included in Price - add 20% when not shipped with an adaptor or wholegood to get a free ride

See Suddenshipping.com to see if we have your model and for lead-time

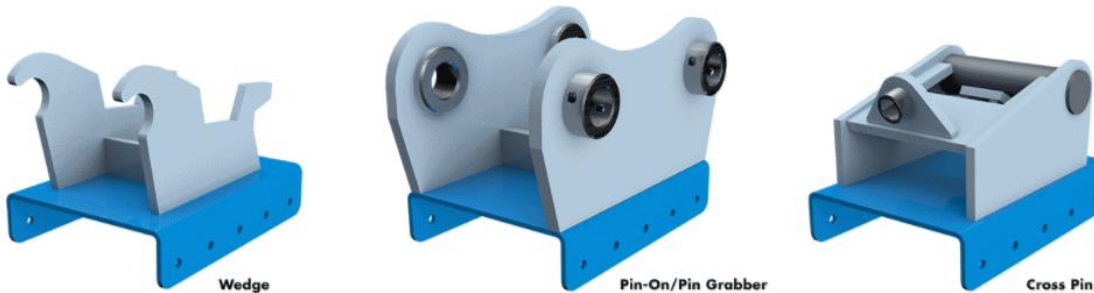

Excavator Adaptor Pin Sizes and Prices				
Part Number	Class	Diameter(mm)	Ton	Set **
D003569	1.5	25-30		\$108
D003569	3	35-40	1.5 to 3	\$127
D003569	5	45-50	3 to 6	\$175
D003569	6	45-50	7 to 9	\$207
D003569	8	45-55	10 to 11	\$233
D003569	13	60-65	12 to 15	\$271
D003569	15	65-80	16 to 19	\$334
D003569	20	80	20 to 22	\$355
D003569	25	80-90	23 to 29	\$434
D003569	30	90-100	30 to 34	\$493
D003569	40	100-110	35 to 40	\$614
D003569		over 110	Over 40	Quote

*Use part number D003569 and indicate Class when ordering

** Add 20% when not shipped with an adaptor to get a free ride



BAUMALIGHT

LIGHT INDUSTRIAL EQUIPMENT

PRODUCTS FOR TRACTORS. SKIDSTEERS AND EXCAVATORS

Augers
Boom Mowers
Brush Mulchers
Feller Bunchers
Generators

Rotary Brush Mowers
Screw Splitters
Stump Grinders
Stump Planers
Tile Drainage Plows

Tree Saws
Tree Shears
Tree Spades
Trenchers

NEW FOR 2021

CHECK INSIDE FOR FULL DETAILS ON THESE EXCITING NEW PRODUCTS!



MS1160 BRUSH MULCHER

Performance Boosting Mulcher Rings
Licensed by Denis Cimaf

Powered by Bent Axis Piston Motor
75" Mulching Path

HGW30 SELF-PROPELLED STUMP GRINDER

8 WEEKS
8% SAVES \$8

30 HP Kohler 999cc Motor
Powered by Bent Axis Piston Motor
Wear Sharp Teeth TM



MS960 MULCHER - REDESIGNED FRAME

Improved Visibility of Mulching Area
Rotor Closer to Carrier for Better Weight Management

Heavy Duty AR400 Steel Frame



R9000 Ripper Teeth



NOW FULL WARRANTY ON MORE BOOM MOWERS FOR SKIDSTEER!

Included Models: SWA500, SWA550, SWA560,
SWF560, SWF580, SWA750



TABLE OF CONTENTS

Teeth Options	4
Augers.....	6
Trenchers	12
Tree Spades	14
Holt Industrial Tree Spades	18
Generators	22
Stump Grinders	28
Screw Splitters.....	38
Stump Planers.....	38
Tree Shears	40
Tree Saws	48
Feller Bunchers.....	54
Rotary Brush Mowers	56
Boom Mowers	64
Brush Mulchers	66
Tile Drainage Plows	80
Auxiliary Electrical Connectors	84
Excavator Mounting	86

TEETH OPTIONS

FREE
 REPLACEMENT
 WITH NEW PURCHASE
 OF WHOLE GOODS
 SEE ONLINE FOR DETAILS



F2000
Flail Tooth



F3000 (Sold Individually)
Flail Tooth



G3000*
GreenTeeth®



W3000*
Wearsharp®



H3000
High Speed



S1000
Planer



P5000
Planer



R5000
Ripper



P7000
Planer



R7000
Ripper



R9000
Ripper



T9000
Planer (holder sold separate)



P11000
Planer



B8000
Beaver (holder sold separate)

*GeethTeeth® and Wearsharp® are trademarks of Green Manufacturing, Inc.



REPLACEMENT TEETH

PART #	CATEGORY	DESCRIPTION	BULK PRICE	PRICE
F2000	Flail	Mulcher Flail Tooth		\$3.60
F3000	Flail	6 mm Heavy Flail Blade (sold in singles, set of two required)		\$3.20
G3000*	Round tooth	GreenTeeth® - Carbide Tipped 3/8" Thread (nut not included)		\$19.20
D002039*	Round tooth	24-pack of G3000 GreenTeeth®	\$16.00	\$384.00
W3000*	Round tooth	Wearsharp® - Carbide Tipped 5/16" Thread (nut not included)		\$20.00
D004930*	Round tooth	24-pack of W3000 Wearsharp® Teeth	\$16.40	\$393.60
H3000	Round tooth	Baumalight High Speed Carbide Tipped 3/8" thread (nut not included)		\$11.20
D004978	300 Series	24-pack of H3000 High Speed Teeth	\$8.00	\$192.00
S1000	300 Series	Stump Grinder Tooth - 5/8" Fine Thread - 3/4" Square		\$14.40
D001627	300 Series	24-Pack of S1000 Teeth	\$9.20	\$220.80
P5000	500 Series	Planer Mulcher Tooth with 5/8" Shank		\$14.80
D001774	500 Series	24-Pack of 500 Series Planer Teeth	\$11.20	\$268.80
R5000	500 Series	Ripper Mulcher Tooth with 5/8" Shank		\$16.40
D002330	500 Series	24-Pack of 500 Series Ripper Teeth	\$12.00	\$288.00
P7000	700 Series	Planer Mulcher Tooth		\$38.40
D002267	700 Series	30 Pack of 700 Series Planer Mulcher Teeth	\$28.80	\$864.00
R7000	700 Series	Ripper Mulcher Tooth		\$36.00
D002268	700 Series	30 Pack of 700 Series Ripper Mulcher Teeth	\$26.40	\$792.00
R9000	900 Series	Ripper Mulcher Tooth		\$65.60
D005540	900 Series	14 - Pack of R9000 Series Ripper Mulcher Teeth	\$58.40	\$817.60
T9000	900 Series	Bolt-on Planer Tip Tooth (holder sold separate)		\$30.40
P11000	1100 Series	Planer Mulcher Tooth		\$36.00
D004861	1100 Series	12- Pack of 1100 Series Planer Mulcher Teeth	\$30.40	\$364.80
B8000	Saw tooth	Beaver Planer Tooth for Tree Saws (holder sold separate)		\$29.60

*GeethTeeth® and Wearsharp® are trademarks of Green Manufacturing, Inc.

WEAR PARTS (See pictures online)

PART #	CATEGORY	DESCRIPTION	BULK PRICE	PRICE
D003977	Flail	D-Ring for Hanging Flail Teeth		\$2.80
D003978	Flail	Clip for Hanging Flail Teeth		\$2.40
D004931	Round tooth	5/16" Standard Lock Nut for Round Teeth		\$0.74
D001625	Round tooth	3/8" Standard Lock Nut for Round Teeth		\$0.76
D001678	Round Tooth	Shim for Round Teeth		\$1.56
D005084	Tooth Holder	300 Series Round Tooth Holder - Angled Baumalight (cannot sell in US)		\$9.60
D001679	Tooth Holder	300 Series Round Tooth Holder - Angled 700LP-A Green Mfg (US Patent #US9241448B2)		\$20.00
D002741	Tooth Holder	300 Series Round Tooth Holder - Straight		\$15.60
D001676	300 Series	Inner (weld-on) Plate for Outer Round Tooth Holder (Mulchers)		\$14.80
D001775	Round Tooth	5/8" Bolt for Round Tooth Holder		\$4.40
D002494	Round tooth	G3000 4x Tooth Holder for GXM350 Stump Grinder (AR400)		\$42.40
D002169	Round Tooth	G3000 5x Tooth Holder for GXM550/GXM750 Stump Grinder (AR400)		\$96.00
D002930	Round Tooth	1/2" x 4.5" Allen Bolt (for above)		\$4.40
D003328	Round Tooth	1/2" Fine Stover Lock Nut (for above)		\$1.40
D001773	General	5/8" Fine Stover Lock Nut for S1000 & 500 Series Teeth		\$2.08
D002121	Bulk Pack	52 Pack of 5/8" Fine Stover Lock Nut for S1000 & 500 Series Teeth	\$1.54	\$80.00
D002924	Weld-on	Tooth Holder Block for S1000 Teeth (Weld-in)		\$6.72
D001343	Weld-on	Tooth Holder for 500 Series Teeth (Weld-on)		\$26.40
D001776	700 Series	Bolt for 700 Series Mulcher Teeth (5/8" Fine Thread x 3")		\$4.80
D002269	Bulk Pack	75 Pack of Bolts for 700 Series Mulcher Teeth (5/8" Fine Thread x 3")	\$2.40	\$180.00
D001671	Weld-on	Tooth Holder for 700 Series Teeth (Weld-on)		\$46.40
D003950	Disk Mulcher	700 Series Disc Mulcher Tooth Holder - Down Angle		\$52.00
D002836	Disk Mulcher	700 Series Disc Mulcher Teeth Holder - Top		\$56.00
D002837	Disk Mulcher	700 Series Disc Mulcher Teeth Holder - Straight		\$37.60
D002860	Disk Mulcher	700 Series Disc Mulcher Teeth Holder - Bottom		\$72.00
D004928	900 Series	Bolt for 900 Series Mulcher Teeth (M20-1.5 x 60)		\$5.60
D004427	Weld-on	Tooth Holder for 900 & 1100 Series Teeth (Weld-on)		\$52.00
D004728	900 Series	Bolt-on Sub-holder for T9000 Mulcher Tooth		\$41.60
D004929	900 Series	Bolt to Bolt-on T9000 tip (M14x1.5x35)		\$4.00
D004261	Tooth Holder	Tooth Holder for B8000 Beaver Teeth		\$120.00

Visit baumalight.com for full teeth details

AUGERS

OWNER OPERATOR & CONTRACTOR



PRODUCT FEATURES

- Variety of mounting options, drive sizes and shapes
- Many available bits, adapters and extensions
- Single bolt-on bit design for quick bit changes
- Universal joint for strength and self-leveling
- Quick lead-time and free shipping
- Optional hydraulic hoses with flat-faced couplers

Visit baumalight.com for additional product information and product videos.

OWNER OPERATOR SERIES



RC442 - 2" Round Drive

6-14 Rec. GPM to 18 Max. GPM
Gear drive
1" pivot pins
Standard frame
Skidsteer size: 1500 - 5000 lbs
Excavator size: 2000 - 4000 lbs
3.18:1 gear ratio
98 lbs. shipping weight (drive only)
Adapter code: A

\$1,608 (Drive with hoses)

\$1,400 (Drive only)



RC582 - 2" Hex Drive

6-24 Rec. GPM to 25 Max. GPM
Planetary drive
1" pivot pins
Standard frame
Skidsteer size: 1500 - 6000 lbs
Excavator size: 2000 - 6000 lbs
3.6:1 gear ratio
124 lbs. shipping weight (drive only)
Adapter code: B

\$2,352 (Drive with hoses)

\$2,144 (Drive only)



RC442 Flow Chart

■ RPM ■ Foot Pounds Torque

GPM	1,000 PSI		1,250 PSI		1,500 PSI		1,750 PSI	
6	52.5	305	51.3	380	49.4	407	47.8	540
10	88.1	293	86.5	368	84.3	441	81.8	521
14	125.2	274	123.3	352	121.4	425	118.9	497
16	146.2	249	145.3	328	143.4	399	140.6	485

On low flows torque is more important than speed

RC582 Flow Chart

■ RPM ■ Foot Pounds Torque

GPM	1,500 PSI		2,000 PSI		2,500 PSI		3,000 PSI	
6	29.4	757	28.3	1,028	26.4	1,290	23.3	1,538
10	50.6	734	48.9	1,004	46.4	1,272	41.7	1,529
16	82.2	678	80.3	944	75.8	1,207	71.4	1,479
20	103.3	630	101.4	893	96.7	1,160	91.9	1,426
22	113.9	602	111.9	866	106.9	1,135	102.2	1,400
24	124.7	572	122.5	837	117.5	1,108	112.5	1,374

CONTRACTOR SERIES



RC586 - 2" Hex Drive

10-24 Rec. GPM to 25 Max. GPM
Heavy duty planetary drive
1 1/2" pivot pins with brass bushings
Heavy duty frame
Skidsteer size: 2000 - 8,000 lbs
Excavator size: 3000 - 20,000 lbs
6:1 gear ratio
158 lbs. shipping weight (drive only)
Adapter code: D

\$2,808 (Drive with hoses)

\$2,600 (Drive only)



RC780 - 2" Hex Drive

20-40 Rec. GPM to 45 Max. GPM
Heavy duty planetary drive
1 1/2" pivot pins with brass bushings
Heavy duty frame
Skidsteer size: 3000 - 12,000 lbs
Excavator size: 4000 - 30,000 lbs
5:1 gear ratio
460 lbs. shipping weight (drive only)
Adapter code: D

\$3,400 (Drive with hoses)

\$3,192 (Drive only)



WHY HEX DRIVE?

With a round auger drive, in time the cross pin can wear and the torque can cause the pin holes to warp. With a hex auger drive, you get 6 flat surfaces driving the auger, allowing for greater torque and a longer life.

Prices do not include mounting plate, see mounting plate page for mounting options. Additional Contractor Series models are available online at baumalight.com.

RC586 Flow Chart

■ RPM ■ Foot Pounds Torque

GPM	1,500 PSI		2,000 PSI		2,500 PSI		3,000 PSI	
6	17.7	1,262	17.0	1,713	15.8	2,150	14.0	2,564
10	30.3	1,223	29.3	1,673	27.8	2,120	25.0	2,549
16	49.3	1,130	48.2	1,573	45.5	2,011	42.8	2,465
20	62.0	1,050	60.8	1,489	58.0	1,934	55.2	2,377
22	68.3	1,004	67.2	1,444	64.2	1,892	61.3	2,333
24	74.8	954	73.5	1,395	70.5	1,847	67.5	2,291

RC780 Flow Chart

■ RPM ■ Foot Pounds Torque

GPM	2,000 PSI		2,500 PSI		3,000 PSI		3,500 PSI	
20	44.8	2,294	42.8	2,870	39.8	3,447	36.4	4,006
24	54.1	2,289	51.5	2,879	49.1	3,463	45.9	4,023
28	63.4	2,281	61.0	2,870	58.4	3,459	54.1	4,006
32	72.9	2,243	70.1	2,841	67.5	3,438	63.4	3,973
40	90.3	2,167	87.3	2,769	84.6	3,375	79.8	3,880

AUGER BITS



AGGRESSOR AUGERS - 30"

2" SHAFT	DIMENSIONS DIAM. X LEN.	WEIGHT (LBS.)	PRICE
137140	6" x 30"	35	\$307
137141	9" x 30"	39	\$309
137142	12" x 30"	47	\$320



AG AUGERS

2" SHAFT	DIMENSIONS DIAM. X LEN.	WEIGHT (LBS.)	PRICE
553228	6" x 48"	40	\$316
553229	9" x 48"	60	\$320
553230	12" x 48"	65	\$328



AGGRESSOR AUGERS - TREE AUGER

2" SHAFT	2-9/16" SHAFT	2" HEX	DIMENSIONS DIAM. X LEN.	WEIGHT (LBS.)	PRICE
103785	135532	135533	4" x 48"	39	\$496
135578	135542	135554	18" Tree Auger	150	\$680
135579	135543	135555	24" Tree Auger	175	\$824
135580	135544	135556	30" Tree Auger	240	\$1178
135581	135545	135557	36" Tree Auger	315	\$1528



4" Augers have a Special Pilot Tip (#133407)



BOLT-ON ROCK HEAD (replaces teeth and pilot bit)

	DIMENSIONS	WEIGHT	PRICE
137991	6-BOR kit 6"	24	\$396
137992	9-BOR kit 9"	36	\$488
137993	12-BOR kit 12"	43	\$528
137994	15-BOR kit 15"	47	\$584
137995	18-BOR kit 18"	62	\$620
137996	24-BOR kit 24"	79	\$760
137990	P-21-RR Carbide Tooth (rock head)	0.6	\$13



AGGRESSOR PARTS

	DIMENSIONS	WEIGHT	PRICE
134519	40/50 Carbide Tooth (Aggressor)	0.4	\$27
134802	40/50 HFF Hardfaced tooth (Aggressor)	0.4	\$17
D001743	Nut & Bolt for Aggressor Tooth	0.2	\$7
135088	T350 Tri-Flow Pilot Bit	5	\$36
133407	Pilot Bit for 4" auger [SB-45]	3	\$64
134501	Standard 40/50 tooth for Aggressor auger	0.4	\$7



INTERLOK AUGER BITS



The Interlok system of auger bits and couplers offers exceptional versatility – you can now connect to more drive sizes with one bit. Equipped with an innovative coupler system, Interlok Aggressor augers feature a heavy-duty twist lock collar on the bits. Drive side couplers are available in 2” and 2-9/16” round and 2” and 2 ½” hex sizes to fit the most common drive sizes.

INTERLOK AUGERS

ITEM	NUMBER	WEIGHT	PRICE
6” Aggressor Sub	157200	49	\$214
9” Aggressor Sub	157201	73	\$356
12” Aggressor Sub	157202	109	\$432
15” Aggressor Sub	157203	112	\$576
18” Aggressor Sub	157204	140	\$672
24” Aggressor Sub	157205	205	\$796
30” Aggressor Sub	157206	215	\$1,160
36” Aggressor Sub	157207	290	\$1,440



154015

INTERLOK COUPLERS

ITEM	NUMBER	WEIGHT	PRICE
R-200 INTERLOK (2” Round)	154073	5	\$133
R-256 INTERLOK (2-9/16” Round)	154074	5	\$133
R-256 INTERLOK (2” Hex)	154075	5	\$135
R-250 INTERLOK (2.5” Hex)	154076	5	\$133
Lock bolt	154015	1	\$30



2” HEX Drive



2 1/2” HEX Drive



2” Round Drive



2 9/16” Round Drive

Visit baumalight.com for more information on available auger bits.

CHEATER ADAPTERS



2" ROUND ADAPTERS

D001286 \$152
2" Round FM to 2-9/16" Round Male Adapter - 15 lbs 

D001287 \$60
2" Round FM to 2-9/16" Round Male Bushing - 2 lbs 

D001319 \$188
2" Round FM to 2" Hex Male Adapter - 17 lbs 

2 9/16" ROUND ADAPTERS

D001279 \$280
2-9/16" Round FM to 2" Round Male Adapter - 18 lbs 

D001318 \$280
2-9/16" Round FM to 2" Hex Male Adapter - 17 lbs 

D002997 \$316
2-9/16" FM to 2.5" Hex Male Adapter - 27 lbs 

2" HEX ADAPTERS

D001280 \$280
2" Hex FM to 2" Round Male Adapter - 17 lbs 

D001310 \$252
2" Hex FM to 2-9/16" Round Male Adapter - 17 lbs 

D002996 \$360
2" Hex FM to 2.5" Hex Male Adapter - 23 lbs 

2.5" HEX ADAPTERS

D002791 \$636
2.5" Hex FM to 2" Hex Male Adapter - 27 lbs 

D002995 \$608
2.5" Hex FM to 2-9/16" Male Adapter - 32 lbs 

BIT EXTENSIONS

PART #	LENGTH	DESCRIPTION	WEIGHT	PRICE
D001381	24"	2" Round Male to Female Bit Extension	28 lbs	\$236
D001382	48"	2" Round Male to Female Bit Extension	50 lbs	\$296
D001384	24"	2-9/16" Round Male to Female Bit Extension	49 lbs	\$304
D001385	48"	2-9/16" Round Male to Female Bit Extension	85 lbs	\$460
D001734	24" (Full Length)	2" Hex Male to Female Bit Extension	49 lbs	\$288
D001735	48" (Full Length)	2" Hex Male to Female Bit Extension	85 lbs	\$384
D001549	24" (Adjustable)	2" Hex Male to Female Bit Extension	49 lbs	\$520
D001551	48" (Adjustable)	2" Hex Male to Female Bit Extension	85 lbs	\$760
D002793	24" (Full Length)	2.5" Hex Male to Female Bit Extension	53 lbs	\$720
D002795	48" (Full Length)	2.5" Hex Male to Female Bit Extension	88 lbs	\$860

FASTENER FOR 2" ROUND EXTENSIONS



D001918 \$5
1/2 x 3.75 Bolt
2" Round
Auger Bit
Extension



D001919 \$2
1/2 Nylon
Insert Locknut



D001920 \$7
7/8 x 5.5 Bolt
2-9/16" Round
Auger Bit
Extension



D001921 \$4
7/8 Nylon
Insert Locknut

FASTENER FOR 2-9/16" ROUND EXTENSIONS



D002008 \$6
3/4" Pin
2" Hex Auger
Bit Extension



S1014 \$2
2" Hex
Linch Pin

PINS FOR 2" HEX EXTENSIONS

MOUNTING PLATES

BOBCAT MINI SKIDSTEER

ASV RC30 & TEREC PT30

PART #	PIN SIZE	ADAPTOR CODE	DESCRIPTION	OPERATOR	PRICE
D001648	1"	A & B	1" pin Bob Cat mini plate	Owner Operator	\$416
D003454	1"	A & B	1" pin ASV & Terex RC30 & PT30	Owner Operator	\$446
D003544	1.5"	D	1.5" pin Bobcat Mini Skidsteer	Construction	\$500
D003568	1.5"	D	1.5" pin ASV & Terex RC30 & PT30	Construction	\$520

BUCKET MOUNT

PART #	PIN SIZE	ADAPTOR CODE	DESCRIPTION	OPERATOR	PRICE
D001308	1"	A & B	1" cross pin and 8 ft. chain	Owner	\$668
D001420	1.5"	D	1.5" cross pin and 8 ft. chain	Owner	\$720

MINI SKIDSTEER

PART #	PIN SIZE	ADAPTOR CODE	DESCRIPTION	OPERATOR	PRICE
D001145	1"	A & B	1" pin Mini Skid steer plate	Owner Operator	\$320
D003532	1.5"	D	1.5" pin mini skidsteer plate / cradle	Construction	\$472
D004684	1"	B	1" pin mini skidsteer plate with cradle	Owner	\$464

UNIVERSAL MOUNT

PART #	PIN SIZE	ADAPTOR CODE	DESCRIPTION	OPERATOR	PRICE
D001369	1"	A & B	1" Pin Standard plate	Owner Operator	\$460
D003472	1"	B	1" Pin Standard plate with cradle	Owner Operator	\$592
D001032	1.5"	D	1.5" Pin Standard plate	Owner Operator	\$720
D003473	1.5"	D	1.5" Pin (Heavy) Plate with cradle	Construction	\$760

WELD-ON PLATE

PART #	PIN SIZE	ADAPTOR CODE	DESCRIPTION	OPERATOR	PRICE
D001328	1"	A & B	Blank weld-on plate with shear pins	Owner	\$96
D003527	1"	B	1" pin blank weld on plate with cradle	Construction	\$212
D003528	1.5"	D	1.5" pin blank weld on plate / cradle	Construction	\$296
D001386	1.5"	D	Blank for weld-on plate	Owner	\$100
D002014	1.5"	F	Blank for weld-on plate	Owner	\$136
D003187	2"	H	Blank for weld-on plate	Owner	\$168

HYDRAULIC HOSE KIT

PART #	DESCRIPTION	PRICE
D002118	1/2 Hose Set without couplers 4 ft	\$108
D002119	1/2 Hose Set without couplers 8 ft	\$132
D001698	Skid Steer Hose Set with Standard Flow Couplers (shown) 8 ft	\$208

Hoses not offered for excavator mount



MOUNT FOR EXCAVATORS

DESCRIPTION
Turn to our excavator mounting section for turn key normal adapters 1/2 price for type pictured on the right, call for details. 866-820-7603



Visit baumalight.com for more mounting plate information and photos.

TRENCHERS



PRODUCT FEATURES

- Side auger keeps dirt clear when trenching
- Crumb scraper bar sweeps debris into the chain
- Planetary drive system
- Heavy duty solid steel nose
- Grease cylinder adjustable chain tensioner
- Wide variety of chain options & excavator mounts
- Optional 3PH mount and external controls

Visit baumalight.com for additional product information and product videos.

MODELS



TN236

36" Trencher Depth
4" to 6" Trencher Width
2-9/16" solid hardened steel main shaft
Hydraulic relief over torque protection
810 lbs.
Mini Skidsteer
20 GPM Max (10 GPM min)

Standard Cup Tooth Chain	50/50 Rock & Cup Tooth Chain
\$4,760 (36x4" chain)	\$5,356 (36x4" chain)
\$4,796 (36x6" chain)	\$5,540 (36x6" chain)



TN336

36" Trencher Depth
4" to 6" Trencher Width
2-9/16" solid hardened steel main shaft
Hydraulic relief over torque protection
Skidsteer up to 3 ton
Quick Hitch Compatible: No
850 lbs.
Skidsteer
20 GPM Max (10 GPM min)
Tractor/Excavator
21 GPM Max (15 GPM min)

Standard Cup Tooth Chain	50/50 Rock & Cup Tooth Chain
\$5,680 (36x4" chain)	\$6,276 (36x4" chain)
\$5,716 (36x6" chain)	\$6,460 (36x6" chain)



TN548

48" Trencher Depth
6" to 10" Trencher Width
2-9/16" solid hardened steel main shaft
Hydraulic relief over torque protection
Skidsteer up to 4 ton
Quick Hitch Compatible: No
1,250 lbs.
Skidsteer
25 GPM Max (12 GPM min)
Tractor/Excavator
25 GPM Max (18 GPM min)

Standard Cup Tooth Chain	50/50 Rock & Cup Tooth Chain
\$5,960 (48x6" chain)	\$6,716 (48x6" chain)
\$6,320 (48x8" chain)	\$7,180 (48x8" chain)
\$6,620 (48x10" chain)	\$7,516 (48x10" chain)



TN560

60" Trencher Depth
6" to 10" Trencher Width
2-9/16" solid hardened steel main shaft
Hydraulic relief over torque protection
Skidsteer from 3.5 ton
Quick Hitch Compatible: No
1,500 lbs.
Skidsteer
25 GPM Max (12 GPM min)
Tractor/Excavator
25 GPM Max (22 GPM min)

Standard Cup Tooth Chain	50/50 Rock & Cup Tooth Chain
\$6,668 (60x6" chain)	\$7,520 (60x6" chain)
\$6,772 (60x8" chain)	\$8,280 (60x8" chain)
\$7,340 (60x10" chain)	\$8,440 (60x10" chain)



TN760

60" Trencher Depth
6" to 10" Trencher Width
Hex solid hardened steel main shaft
Hydraulic relief over torque protection
Skidsteer from 4 ton
Quick Hitch Compatible: No
1,800 lbs.
Skidsteer
42 GPM Max (20 GPM min)
Tractor/Excavator
42 GPM Max (28 GPM min)

Standard Cup Tooth Chain	50/50 Rock & Cup Tooth Chain
\$8,028 (60x6" chain)	\$8,880 (60x6" chain)
\$8,132 (60x8" chain)	\$9,640 (60x8" chain)
\$8,700 (60x10" chain)	\$9,800 (60x10" chain)

OPTIONS



3PH TRACTOR MOUNT

This Baumalight Trencher can also be mounted to a tractor. The optional 3-point hitch tractor mount has a cylinder that provides angle and depth control. To use this 3PH adapter, your tractor must have a hydro-static drive and two hydraulic remotes. External control kit(S1050) is available for tractors with only one set of external hydraulic connections.
Quick Hitch Compatible: No

D001393 \$1,024

3PH EXTERNAL CONTROL

This optional external control kit is mounted on an adjustable arm. The control is great for smaller tractors with limited HP and for tractors with only one hydraulic remote.
Quick Hitch Compatible: No

S1050 \$680

TREE SPADES

TRACTOR



PRODUCT FEATURES

- Available with Electric control (see pictures online)
- Secure hydraulic connections and easy servicing
- All hoses are sleeved for operator and hose protection
- Heavy-duty construction and a durable powder-coated finish
- Lifting eyes for easy storage and transport
- Semi truncated blades
- Cylinders push for maximum efficiency
- Universal skidsteer adaptor if 3P is removed
- JIC fittings on hoses
- Power Built-in
- Greasable Pins
- Optional stabilizer
- Metal shipping stand (picture online)

Visit baumalight.com for additional product information and product videos.

TRACTOR MOUNT MODELS



PT324

20" Opening width
 2" Tree size (Evergreen)
 1.5" Tree size (Hardwood)
 24" Root ball diameter
 23" Root ball depth
 25° Blade angle
 3 blades
 1/4" Mild steel blades, Steel slides
 Semi blade truncation
 Quick Hitch Compatible: No
 1,100 lbs unit weight
 1,400 lbs weight with root ball
Minimum Carrier Weight
 3PH 3,000 lbs min

\$9,232 (Manual Controls)
\$10,192 (Electric Controls*)



PT330

23" Opening width
 3" Tree size (Evergreen)
 2.5" Tree size (Hardwood)
 30" Root ball diameter
 29" Root ball depth
 25° Blade angle
 3 blades
 3/8" Mild steel blades, Steel slides
 Semi blade truncation
 Quick Hitch Compatible: No
 1,356 lbs unit weight
 1,865 lbs weight with root ball
Minimum Carrier Weight
 3PH 4,000 lbs min

\$11,600 (Manual Controls)
\$12,560 (Electric Controls*)



PS330

60" Opening width
 3" Tree size (Evergreen)
 2.5" Tree size (Hardwood)
 30" Root ball diameter
 29" Root ball depth
 25° Blade angle
 3 blades
 3/8" Mild steel blades, Steel slides
 Semi blade truncation
 Towers Swing Hinge
 Quick Hitch Compatible: No
 1,550 lbs unit weight
 2,050 lbs weight with root ball
Minimum Carrier Weight
 3PH 4,000 lbs min

\$12,800 (Manual Controls)
\$13,840 (Electric Controls*)



PT440

52" Opening width
 4" Tree size (Evergreen)
 3" Tree size (Hardwood)
 40" Root ball diameter
 30" Root ball depth
 25° Blade angle
 4 blades
 1/4" High alloy AR400 blades, Steel slides
 Full blade truncation
 Towers Swing Hinge
 Quick Hitch Compatible: No
 1,934 lbs unit weight
 3,134 lbs weight with root ball
Minimum Carrier Weight
 3PH 6,000 lbs min

\$15,876 (Manual Controls)
\$17,040 (Electric Controls*)



PT650

47" Opening width
 3" Tree size (Evergreen)
 2.5" Tree size (Hardwood)
 30" Root ball diameter
 29" Root ball depth
 25° Blade angle
 3 blades
 1/4" High alloy AR400 blades, Steel slides
 Semi blade truncation
 Towers Swing Hinge
 Quick Hitch Compatible: No
 3,238 lbs unit weight
 5,785 lbs weight with root ball
Minimum Carrier Weight
 3PH 10,000 lbs min

\$26,720 (Manual Controls)
\$27,880 (Electric Controls*)

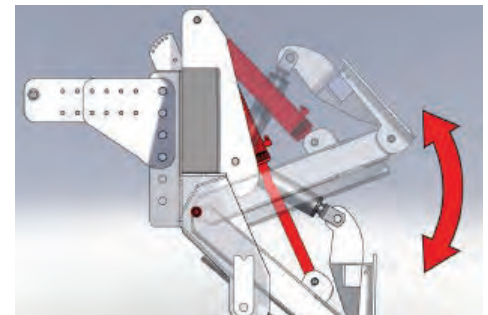

Power Built-In

The 3-point hitch mount is designed for power and function. Attached to your tractor by a rigid top link and the lower arms in their lowest position, this rugged power house is ready to take on all the heavy lifting and positioning. The built-in hydraulics are designed to provide, tilt for positioning, down pressure to help keep the frame in position and lift to get the Nomad out of the hole. These powerful tools are also field installable, meaning you can add 3PH mount to an existing Nomad.

*Comes with 20 ft of wire - Needs 12V wire to spade

TREE SPADES

SKIDSTEER



PRODUCT FEATURES

- Non slip step pads for easy entry
- Available with Electric control (pictures online)
- All hoses are sleeved for operator and hose protection
- Heavy-duty construction and a durable powder-coated finish
- Lifting eyes for easy storage and transport
- Semi truncated blades
- Cylinders push for maximum efficiency
- Universal skidsteer adaptor
- Bolt in tractor loader adaptors available
- Optional stabilizer
- Optional Outrigger for skidsteers

Visit baumalight.com for additional product information and product videos.

SKIDSTEER MOUNT MODELS



ST324

20" Opening width
2" Tree size (Evergreen)
1.5" Tree size (Hardwood)
24" Root ball diameter
23" Root ball depth
3 blades, 25° Blade angle
1/4" Mild steel blades, Steel slides
Semi blade truncation
1,100 lbs unit weight (1,400 lbs w/ root ball)

\$6,112 (Manual Controls)
\$7,072 (Electric Controls*)
\$7,392 (Wireless Hand Controls*)
\$6,948 (Wireless Controls - AUX)
\$6,632 (AUX Connections~)



ST440

52" Opening width
4" Tree size (Evergreen)
3" Tree size (Hardwood)
40" Root ball diameter
30" Root ball depth
4 blades, 25° Blade angle
1/4" AR400 steel blades, Steel slides
Full blade truncation
Towers Swing Hinge
1,934 lbs unit weight (3,134 lbs w/ root ball)

\$784 (D005198 Extension Plate*)**
\$11,476 (Manual Controls)
\$12,640 (Electric Controls*)
\$13,280 (Wireless Hand Controls*)
\$12,600 (Wireless Controls - AUX)
\$13,156 (AUX Connections~)

Minimum Carrier Weight

MODEL	ST324	ST330	SS330	ST440	ST650
Wheeled Skidsteer	5,000 lbs	6,000 lbs	6,000 lbs	7,000 lbs	9,200 lbs
Tracked Skidsteer	4,500 lbs	5,200 lbs	5,200 lbs	6,500 lbs	8,500 lbs
Wheel Loader	4,000 lbs min	4,800 lbs min	4,800 lbs min	6,000 lbs min	8,000 lbs min
Tracked Loader	4,000 lbs min	5,200 lbs min	5,200 lbs min	7,800 lbs min	13,000 lbs min
Backhoe	4,000 lbs	4,800 lbs	4,800 lbs	6,000 lbs	8,000 lbs
Telehandler	4,000 lbs	4,800 lbs	4,800 lbs	6,000 lbs	8,000 lbs



ST330

23" Opening width
2" Tree size (Evergreen)
2.5" Tree size (Hardwood)
30" Root ball diameter
29" Root ball depth
3 blades, 25° Blade angle
3/8" Mild steel blades, Steel slides
Semi blade truncation
1,356 lbs unit weight (1,865 lbs w/ root ball)

\$7,200 (Manual Controls)
\$8,160 (Electric Controls*)
\$8,480 (Wireless Hand Controls*)
\$8,036 (Wireless Controls - AUX)
\$7,720 (AUX Connections~)



ST650

47" Opening width
5" Tree size (Evergreen)
4" Tree size (Hardwood)
50" Root ball diameter
43" Root ball depth
6 blades, 25° Blade angle
1/4" AR400 steel blades, Steel slides
Semi blade truncation
Towers Swing Hinge
3,238 lbs unit weight (5,785 lbs w/ root ball)

\$19,120 (Manual Controls)
\$20,280 (Electric Controls*)
\$21,552 (Wireless Hand Controls*)
\$20,920 (Wireless Controls - AUX)
\$21,120 (AUX Connections~)



SS330

60" Opening width
3" Tree size (Evergreen)
2.5" Tree size (Hardwood)
30" Root ball diameter
29" Root ball depth
3 blades, 25° Blade angle
3/8" Mild steel blades, Steel slides
Semi blade truncation
Towers Swing Hinge
1,550 lbs unit weight (2,050 lbs w/ root ball)

\$8,400 (Manual Controls)
\$9,440 (Electric Controls*)
\$10,000 (Wireless Hand Controls*)
\$9,416 (Wireless Controls - AUX)
\$9,120 (AUX Connections~)

CONTROL OPTIONS



Baumalight Tree Spades are available with multiple control options. Visit www.baumalight.com for full details.

*Comes with 20 ft of wire - Needs 12V wire to spade

**Priced without adaptor

***Extension plate required for some skidsteers, more information online (\$560 if shipped with spade)

~Check online to see how many live pins are required

TREE SPADES

 Holt industrial SKIDSTEER

PRODUCT FEATURES

- Simple to use electronic over hydraulic control
- Dual cylinder design provides greater control
- Tower slides effortlessly with no binding and no greasing needed
- Two cylinders on each blade, this will allow you to disconnect one and keep planting should one fail
- Spades have a goose necked base allows the base to compress and keep the rootball intact while the blades dig in
- Frame is made from T1 material
- Full truncated blades
- Outside towers swing open
- Optional AUX Electrical Connection

Visit baumalight.com for additional product information and product videos.



QUALITY BASKETS AT
DOWN-TO-EARTH PRICES

www.settler.biz
sales@settler.biz
call/text 519-589-1603



SKIDSTEER MOUNT MODELS



Holt industrial 34S

- 3.5" Tree size (Evergreen)
- 3" Tree size (Hardwood)
- 34" Root ball diameter
- 23" Root ball depth
- 4 blades, 25° Blade angle
- 5/16 T1 blades, Nylon slides
- Full blade truncation
- 5-25 gpm Hydraulic flow requirements
- 2,000 min hydraulic psi
- 1.47 Gallon Hydraulic Oil displacement
- 1,650 lbs unit weight (2,100 lbs w/ root ball)
- Electric Controls*

\$17,000



Holt industrial 38S

- 4" Tree size (Evergreen)
- 3.5" Tree size (Hardwood)
- 38" Root ball diameter
- 27" Root ball depth
- 4 blades, 25° Blade angle
- 5/16 T1 blades, Nylon slides
- Full blade truncation
- 5-25 gpm Hydraulic flow requirements
- 2,000 min hydraulic psi
- 1.71 Gallon Hydraulic Oil displacement
- 1,920 lbs unit weight (2,720 lbs w/ root ball)
- Electric Controls*

\$17,520



Holt industrial 44S

- 4.5" Tree size (Evergreen)
- 4" Tree size (Hardwood)
- 44" Root ball diameter
- 31" Root ball depth
- 4 blades, 25° Blade angle
- 5/16 T1 blades, Nylon slides
- Full blade truncation
- 5-25 gpm Hydraulic flow requirements
- 2,000 min hydraulic psi
- 1.96 Gallon Hydraulic Oil displacement
- 2,210 lbs unit weight (3,410 lbs w/ root ball)
- Electric Controls*

\$18,800



Holt industrial 48S

- 5" Tree size (Evergreen)
- 4.5" Tree size (Hardwood)
- 48" Root ball diameter
- 38" Root ball depth
- 4 blades, 25° Blade angle
- 5/16 T1 blades, Nylon slides
- Full blade truncation
- 5-25 gpm Hydraulic flow requirements
- 2,000 min hydraulic psi
- 1.96 Gallon Hydraulic Oil displacement
- 2,740 lbs weight (5,240 lbs w/ root ball)
- Electric Controls*

\$21,600



Holt industrial 50S

- 5.5" Tree size (Evergreen)
- 5" Tree size (Hardwood)
- 50" Root ball diameter
- 44" Root ball depth
- 4 blades, 25° Blade angle
- 5/16 T1 blades, Nylon slides
- Semi blade truncation
- 5-25 gpm Hydraulic flow requirements
- 2,000 min hydraulic psi
- 2.94 Gallon Hydraulic Oil displacement
- 3,220 lbs weight (5,705 lbs w/ root ball)
- Electric Controls*

\$25,240



Minimum Carrier Weight

MODEL	34S	38S	44S	48S	50S
Wheeled Skidsteer	6,200 lbs	7,000 lbs	8,800 lbs	10,000 lbs	10,500 lbs
Tracked Skidsteer	5,900 lbs	6,500 lbs	8,300 lbs	9,500 lbs	10,000 lbs
Wheel Loader	5,400 lbs min	6,000 lbs min	7,500 lbs min	8,500 lbs min	9,000 lbs min
Tracked Loader	7,000 lbs min	7,800 lbs min	10,400 lbs min	12,500 lbs min	13,000 lbs min
Backhoe	5,400 lbs	6,000 lbs	7,500 lbs	8,500 lbs	9,000 lbs
Telehandler	5,400 lbs	6,000 lbs	7,500 lbs	8,500 lbs	9,000 lbs

*Comes with 20 ft of wire - Needs 12V wire to spade

TREE SCOOPS



PRODUCT FEATURES

- Safety grip step strips on the top make getting in and out of your skid steer safe and easier
- The mounting plate/adapter/tool carrier is double reinforced at both the top and the bottom.
- gusseted for additional strength
- 8 panel structured shape gives the scoop added strength
- Sharp blade truncation

Visit baumalight.com for additional product information and product videos.

TREE SCOOP MODELS

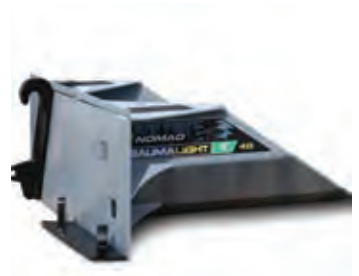

X4M

23" Scoop width
 24" Plate width
 1.5" Tree size (Evergreen)
 1" Tree size (Hardwood)
 22" Root ball diameter
 20" Root ball depth
 1/4" High Alloy AR400 blade
 Standard Mini Skid Steer attachment
 35" Length

\$720

X4C

23" Scoop width
 36" Plate width
 1.5" Tree size (Evergreen)
 1" Tree size (Hardwood)
 22" Root ball diameter
 20" Root ball depth
 1/4" High Alloy AR400 blade
 Bobcat Mini Skid Steer attachment
 36" Length

\$840

X4S

28" Scoop width
 44" Plate width
 2" Tree size (Evergreen)
 1.5" Tree size (Hardwood)
 28" Root ball diameter
 25" Root ball depth
 1/4" High Alloy AR400 blade
 Standard Universal Skid Steer attachment
 Bolt-on loader adapter available
 43" Length
Minimum Carrier Weight
 Wheeled Skidsteer 4,400 lbs
 Tracked Skidsteer 4,000 lbs
 Wheel Loader 3,500 lbs min
 Backhoe 3,500 lbs
 Telehandler 3,500 lbs

\$1,104

X4B

28" Scoop width
 44" Plate width
 2" Tree size (Evergreen)
 1.5" Tree size (Hardwood)
 28" Root ball diameter
 25" Root ball depth
 1/4" High Alloy AR400 blade
 Blank Weld-On Skid Steer attachment
 43" Length
Minimum Carrier Weight
 Wheeled Skidsteer 4,400 lbs
 Tracked Skidsteer 4,000 lbs
 Wheel Loader 3,500 lbs Min.
 Backhoe 3,500 lbs
 Telehandler 3,500 lbs

\$1,000

TREE SPADES TRAILER



PRODUCT FEATURES

- Hydraulic Tongue
- Hydraulic lateral placement
- 2 stage vertical placement
- Gas powered
- Intergrated Safety Chain
- Standard Pintle Hitch
- Hardened Steel Bushing
- Greasable pins
- 20 HP Honda GX630 - 688cc Engine

Visit baumalight.com for additional product information and product videos.

TRAILER MOUNT MODELS



TR330

60" Opening width
 3" Tree size (Evergreen)
 2.5" Tree size (Hardwood)
 30" Root ball diameter
 29" Root ball depth
 3 25° Blade angle
 3/8" Mild steel blades, Steel slides
 Semi blade truncation
 Towers Swing Hinge
 Quick Hitch Compatible: No
 3,950 lbs unit weight
 4450 lbs weight with root ball

\$26,000 (without Power Pack)
\$31,496 (with Power Pack)



TR440

52" Opening width
 4" Tree size (Evergreen)
 3" Tree size (Hardwood)
 40" Root ball diameter
 30" Root ball depth
 4 25° angle blades
 1/4" AR400 steel blades
 Full blade truncation
 Towers Swing Hinge
 Quick Hitch Compatible: No
 4,150 lbs unit weight
 4,986 lbs weight with root ball

\$29,076 (without Power Pack)
\$34,572 (with Power Pack)



TR650

47" Opening width
 5" Tree size (Evergreen)
 4" Tree size (Hardwood)
 50" Root ball diameter
 43" Root ball depth
 6 25° angle blades
 1/4" AR400 steel blades
 Semi blade truncation
 Towers Swing Hinge
 Quick Hitch Compatible: No
 8,238 lbs unit weight
 10,785 lbs weight with root ball

\$56,200 (without Power Pack)
\$61,696 (with Power Pack)



M33-HOLT50S

61/2"*12' Size
 5.5" Tree size (Evergreen)
 4" Tree size (Hardwood)
 50" Root ball diameter
 44" Root ball depth
 4 25° angle blades
 5/16" T1 blades, nylon slides
 Semi blade truncation
 Quick Hitch Compatible: No
 7,250 lbs unit weight
 9,735 lbs weight with root ball

\$ (without Power Pack)
\$42,576 (with Power Pack)

GENERATORS

TX SERIES

8 WEEKS
SAVES \$8%

PRE-ORDER DISCOUNT



GENERATOR ASSEMBLY MADE IN CANADA
MAIN COMPONENT IS MADE IN EUROPE

PRODUCT FEATURES

- Easy view voltage meter
- Brushless design and copper windings
- Push button circuit breaker reset
- Internal operating speed of 3,600 rpm
- Multiple connections on panel
- Self-regulated power within +/- 6%
- 2 year/2000 hour limited warranty

Visit baumalight.com for additional product information and product videos.

TX GENERATOR MODELS



TX MODEL SPECIFICATIONS

MODEL	MAX ELECTRIC MOTOR SIZE CONNECTION	KW	MOMENTARY SURGE KW	MIN TRACTOR 50% LOAD	100% LOAD	120V 20 AMP DUPLEX	WELDER RECEPT VOLTAGE	VOLTS	FULL OUTPUT AMPS	PHASE	SHIP WEIGHT (LBS)	PRICE
TX 7	Dedicated	7	14	5HP	11HP	1	240	120/240	30	1	300	\$2,520
TX 12	Dedicated	12	24	10HP	21HP	2	240	120/240	50	1	370	\$2,940
TX 18	Dedicated	18	37	15HP	34HP	2	240	120/240	80	1	474	\$3,992
TX 25	Dedicated	25	50	19HP	42HP	2	240	120/240	100	1	563	\$4,620
TX 31	Dedicated	31	62	22HP	50HP	2	240	120/240	125	1	596	\$5,320

SEE GENERATOR SIZE CALCULATOR ONLINE

**8 WEEKS 8%
\$ SAVES \$8**

PLANNING AHEAD PAYS OFF. PRE-ORDER DISCOUNT PROGRAM.

To reward and encourage you to plan ahead, Baumalight is offering an 8% discount on pre-ordered generators. This program allows you to order a generator at a discount for delivery in 8 weeks. We all know being prepared before an emergency is best but we all get caught off guard once in a while. This program allows us to reward the prepared and also keep stock for the times when customers have immediate needs.

GENERATORS

KR SERIES

8 WEEKS
\$ SAVES \$8%

PRE-ORDER DISCOUNT



**GENERATOR ASSEMBLY MADE IN CANADA
MAIN COMPONENT IS MADE IN EUROPE**

PRODUCT FEATURES

- Comes with DisplayMaster1 monitoring system
- Reset circuit breakers - protect against short circuit damage
- Brushless design means improved performance with less maintenance
- 4 Copper windings provide more efficient power generation
- Oversized windings enhance quality and stability of power
- Neutral bonded to ground
- Internal operating speed of 1,800 RPM
- Lower Operating Speed increases duty cycle and operating life
- Speed indicating lights make set up quick and easy
- Automatic voltage regulation keeps power stable within 1% +/- down to 56Hz
- High momentary surge capacity up to 3 times working wattage rating for excellent motor starting
- Multiple connection options including:
 - Full power outlet with locking cover
 - 20 amp duplex receptacle
 - 50 amp welder receptacle
- Drip Proof design
- Limited 2 Year/2000 hour Warranty

Visit baumalight.com for additional product information and product videos.

KR GENERATOR MODELS



KR MODEL SPECIFICATIONS

MODEL	CONNECTION	KW	MOMENTARY SURGE KW	MIN TRACTOR 50% LOAD	100% LOAD	120V 20 AMP DUPLEX	WELDER RECEPT VOLTAGE	VOLTS	FULL OUTPUT AMPS	PHASE	SHIP WEIGHT (LBS)	PRICE
KR30	Dedicated	30	85	23	45	2	240	120/240	125	1	750	\$7,080
KR44	Dedicated	44	115	34	65	2	240	120/240	175	1	990	\$8,960
KR52	Dedicated	52	140	39	76	2	240	120/240	225	1	1,060	\$9,600
KR65	Dedicated	65	180	52	97	2	240	120/240	250	1	1,210	\$11,680

SEE GENERATOR SIZE CALCULATOR ONLINE

DisplayMaster1

AT A GLANCE PERFORMANCE MONITOR

- Voltage, Frequency & Amperage
- KW, KVA, Power Factor
- Runtime & KW Hours
- Peak/Average KVA
- Speed indicating lights

WATCH ONLINE VIDEO FOR MORE INFORMATION



Included on all KR & QC Models

GENERATORS

QC SERIES

8 WEEKS
SAVES \$8%

PRE-ORDER DISCOUNT

DisplayMaster1



**GENERATOR ASSEMBLY MADE IN CANADA
MAIN COMPONENT IS MADE IN AMERICA**

PRODUCT FEATURES

- Comes with DisplayMaster1 monitoring system
- Reset circuit breakers - protect against short circuit damage
- Brushless design means improved performance with less maintenance
- 4 Copper windings provide more efficient power generation
- Oversized windings enhance quality and stability of power
- Neutral bonded to ground
- Internal operating speed of 1,800 RPM
- Lower Operating Speed increases duty cycle and operating life
- Speed indicating lights make set up quick and easy
- Automatic voltage regulation keeps power stable within 1% +/- down to 56Hz
- High momentary surge capacity up to 3 times working wattage rating for excellent motor starting
- Multiple connection options including:
 - Full power outlet with locking cover
 - 20 amp duplex receptacle
 - 50 amp welder receptacle
- Drip Proof design
- Limited 2 Year/2000 hour Warranty

Visit baumalight.com for additional product information and product videos.

QC GENERATOR MODELS



QC MODEL SPECIFICATIONS

MODEL	CONNECTION	KW	MOMENTARY SURGE KW	MIN TRACTOR 50% LOAD	MIN TRACTOR 100% LOAD	RPM	WELDER RECEPT VOLTAGE	VOLTS	FULL OUTPUT AMPS	PHASE	SHIP WEIGHT (LBS)	PRICE
QC12	Dedicated	12	25	9HP	21HP	540	240	120/240	50	1	645	\$7,080
QC19	Dedicated	19	35	16HP	34HP	540	240	120/240	90	1	685	\$7,560
QC30	Dedicated	30	85	20HP	49HP	540	240	120/240	125	1	725	\$8,760
QC45	Dedicated	45	120	31HP	75HP	540	240	120/240	175	1	941	\$11,000
QC55	Dedicated	55	150	42HP	89HP	540	240	120/240	225	1	1037	\$12,464
QC65	Dedicated	65	180	48HP	102HP	540	240	120/240	250	1	1156	\$13,440
QC80	Dedicated	80	225	55HP	122HP	1000	240	120/240	320	1	1358	\$14,960
QC100	Dedicated	100	300	71HP	153HP	1000	240	120/240	400	1	1450	\$16,400
SEE GENERATOR SIZE CALCULATOR ONLINE												
QC30-2	Parallel Low WYE	30	85	20HP	49HP	540	208	120/208	100	3	779	\$9,440
QC45-2	Parallel Low WYE	45	120	31HP	75HP	540	208	120/208	150	3	980	\$11,360
QC68-2	Parallel Low WYE	68	190	50HP	105HP	540	208	120/208	250	3	1160	\$13,520
QC105-2	Parallel Low WYE	105	315	72HP	155HP	1000	208	120/208	400	3	1474	\$16,000
QC30-3	Series High DELTA	30	85	20HP	49HP	540	240	120/240	90	3	779	\$9,520
QC45-3	Series High DELTA	45	120	31HP	75HP	540	240	120/240	150	3	995	\$11,440
QC68-3	Series High DELTA	68	190	50HP	105HP	540	240	120/240	225	3	1160	\$13,560
QC105-3	Series High DELTA	105	315	72HP	155HP	1000	240	120/240	320	3	1474	\$16,080
QC30-4	Series High WYE	33	99	20HP	49HP	540	n/a	277/480	50	3	779	\$9,360
QC45-4	Series High WYE	50	150	31HP	75HP	540	n/a	277/480	80	3	995	\$11,200
QC68-4	Series High WYE	76	228	50HP	105HP	540	n/a	277/480	125	3	1160	\$13,440
QC105-4	Series High WYE	113	339	72HP	155HP	1000	n/a	277/480	150	3	1474	\$15,840
QC27-6	Dedicated	27	45	18HP	47HP	540	n/a	347/600	35	3	779	\$8,320
QC50-6	Dedicated	50	130	35HP	80HP	540	n/a	347/600	60	3	1010	\$10,800
QC75-6	Dedicated	75	200	52HP	110HP	1000	n/a	347/600	90	3	1175	\$12,920
QC100-6	Dedicated	100	100	71HP	153HP	1000	n/a	347/600	150	3	1475	\$16,240

STUMP GRINDERS

TRACTOR

FREE
6 Pack of REPLACEMENT
Teeth
WITH PURCHASE
SEE ONLINE FOR DETAILS



PRODUCT FEATURES

- Adjustable flow control for optimal performance
- High number of carbide tipped cutting teeth
- Rugged gear boxes rated from 803 to 1050 ft.-lbs of torque
- 3/4" thick steel rotor
- Floating deflector shield
- Stabilizer base for consistent grinding

Visit baumalight.com for additional product information and product videos.

TRACTOR MOUNT MODELS



1P24

20-45 Recommended HP
50 Maximum Engine HP
40 Maximum PTO HP
24" Rotor Size
540 RPM Cutting Wheel Speed
10" Cutting Height - Above Ground
6" Cutting Depth - Below Ground
5" Maximum Cutting Depth - Per Pass
22" Maximum Horizontal Cut
0° Swing Arc
803 Ft.-Lbs. Hub Torque
Shear bolt Over Torque Protection
Cat I Hitch
Quick Hitch Compatible: Yes
Slip Clutch PTO Shaft
Remote not required
12 Volt DC Not Required
540 Input Speed
350 Lbs Unit Weight (Shipping)
48" Width (Shipping)
48" Length (Shipping)
Replacement Teeth: S1000 Teeth*
34 Teeth

Tractor must have hydro-static drive

\$2,716

3P24

25-55 Recommended HP
65 Maximum Engine HP
55 Maximum PTO HP
5-20 Hydraulic GPM
24" Rotor Size
810 RPM Cutting Wheel Speed
18" Cutting Height - Above Ground
8" Cutting Depth - Below Ground
6" Maximum Cutting Depth - Per Pass
22" Maximum Horizontal Cut
65° Swing Arc
803 Ft.-Lbs. Hub Torque
Slip Clutch Over Torque Protection
Cat I or II Hitch
Quick Hitch Compatible: No
2 Remotes Required - Hydraulic**
12 Volt DC Not Required
540 Input Speed
624 Lbs Unit Weight (Shipping)
42" Width (Shipping)
49" Length (Shipping)
Replacement Teeth: S1000 Teeth*
34 Teeth

\$5,840

3P34

45-80 Recommended HP
85 Maximum Engine HP
75 Maximum PTO HP
5-20 Hydraulic GPM
34" Rotor Size
810 RPM Cutting Wheel Speed
25" Cutting Height - Above Ground
14" Cutting Depth - Below Ground
9" Maximum Cutting Depth - Per Pass
32" Maximum Horizontal Cut
65° Swing Arc
803 Ft.-Lbs. Hub Torque
Slip Clutch Over Torque Protection
Cat II Hitch
Quick Hitch Compatible: No
2 Remotes Required - Hydraulic**
12 Volt DC Not Required
540 Input Speed
1231 Lbs Unit Weight (Shipping)
48" Width (Shipping)
54" Length (Shipping)
Replacement Teeth: S1000 Teeth*
54 Teeth

\$7,360

3P40

60-120 Recommended HP
125 Maximum Engine HP
115 Maximum PTO HP
5-20 Hydraulic GPM
34" Rotor Size
1000 RPM Cutting Wheel Speed
25" Cutting Height - Above Ground
14" Cutting Depth - Below Ground
9" Maximum Cutting Depth - Per Pass
32" Maximum Horizontal Cut
65° Swing Arc
1050 Ft.-Lbs. Hub Torque
Slip Clutch Over Torque Protection
Cat II Hitch
Quick Hitch Compatible: No
2 Remotes Required - Hydraulic**
12 Volt DC Not Required
1,000 Input Speed
1280 Lbs Unit Weight (Shipping)
48" Width (Shipping)
54" Length (Shipping)
Replacement Teeth: S1000 Teeth*
54 Teeth

\$9,400

*See front of the catalog for teeth details and pricing

**S1050 External Control required if only 1 remote available



TRACTOR STUMP CUTTING TIMES BASED ON 30" STUMP

MODEL	20 HP	30 HP	40 HP	60 HP	70 HP	80 HP	90 HP	120 HP
1P24	30 min	20 min	15 min	--	--	--	--	--
3P24	--	15 min	12 min	10 min	--	--	--	--
3P34	--	--	--	6 min	5 min	4 min	--	--
3P40	--	--	--	6 min	5 min	4 min	3 min	2 min

STUMP GRINDERS

SKIDSTEER

FREE
6 Pack of REPLACEMENT
Teeth
WITH PURCHASE
SEE ONLINE FOR DETAILS



PRODUCT FEATURES

- Adjustable flow control for optimal performance
- High number of carbide tipped cutting teeth
- AUX electrical connection available for in cab controls
- Double shielded hoses
- Floating deflector shield
- 12V remote control if no AUX plug

Visit baumalight.com for additional product information and product videos.

SKIDSTEER MOUNT MODELS



S16

Mini Skidsteer model with swing cylinder
Check GPM & PSI for Maximum Carrier Size
Gear Motor
Check Stump Cutting Size Chart for Hydraulic GPM

Cutting Wheel Speed Depends on GPM
No limit Cutting Height - Above Ground

Relieve valve Over Torque Protection
Mini Plate Hitch
1 Remote Required - Hydraulic
Requires 12 Volt DC

Replacement Teeth: W3000 Wearsharp®*

**New model, check out
Factory discounts**

Includes adapter.
Hoses and couplers included.

S24

30-80 Recommended HP size
Check GPM & PSI for Maximum Carrier Size
Roller Vane Motor
Check Stump Cutting Size Chart for Hydraulic GPM
24" Rotor Size
Cutting Wheel Speed Depends on GPM
No limit Cutting Height - Above Ground
10" Cutting Depth - Below Ground
6" Maximum Cutting Depth - Per Pass
22" Maximum Horizontal Cut
80° Swing Arc
250 Ft.-Lbs. Hub Torque
Relieve valve Over Torque Protection
Quick Attach Hitch
1 Remote Required - Hydraulic
Requires 12 Volt DC
920 Lbs Unit Weight (Shipping)
Replacement Teeth: S1000*
34 Teeth

**\$6,700 (S445 motor)
\$7,040 (S545 motor)**

Includes adapter.
Hoses included, couplers NOT included.
Deduct \$100 if ordered with AUX.

S28

50-120 Recommended HP size
Check GPM & PSI for Maximum Carrier Size
Roller Vane Motor
Check Stump Cutting Size Chart for Hydraulic GPM
24" Rotor Size
Cutting Wheel Speed Depends on GPM
No limit Cutting Height - Above Ground
10" Cutting Depth - Below Ground
6" Maximum Cutting Depth - Per Pass
22" Maximum Horizontal Cut
80° Swing Arc
803 Ft.-Lbs. Hub Torque
Relieve valve Over Torque Protection
Quick Attach Hitch
1 Remote Required - Hydraulic
Requires 12 Volt DC
995 Lbs Unit Weight (Shipping)
Replacement Teeth: S1000*
34 Teeth

\$7,880 (S645 motor)

Includes adapter.
Hoses included, couplers NOT included.
Deduct \$100 if ordered with AUX.

S40

50-130 Recommended HP size
Check GPM & PSI for Maximum Carrier Size
High Efficiency Bent Axis Piston
Check Stump Cutting Size Chart for Hydraulic GPM
24" Rotor Size
Cutting Wheel Speed Depends on GPM
No limit Cutting Height - Above Ground
24" Cutting Depth - Below Ground
2" Maximum Cutting Depth - Per Pass
22" Maximum Horizontal Cut
85° Swing Arc (cuts both ways)
Relieve valve Over Torque Protection
Quick Attach Hitch
1 Remote Required - Hydraulic
Requires 12 Volt DC
1,200 Lbs Unit Weight (Shipping)
Replacement Teeth: W3000 Wearsharp®*
20 Teeth

**\$10,520 (S740 motor)
\$11,800 (S770 motor)**

Includes adapter.
Hoses included, couplers NOT included.
Deduct \$100 if ordered with AUX.

*See front of the catalog for teeth details and pricing



SKIDSTEER STUMP CUTTING TIMES BASED ON 24" STUMP

MOTOR	CASE DRAIN	PSI	12 GPM	15 GPM	20 GPM	25 GPM	30 GPM	35 GPM	40 GPM	50 GPM	CC	MOTOR TYPE	RPM AT MAX GPM
S400 Motor Available for: S16	Required	2,500	50 min	40 min	--	--	--	--	--	--	25	Gear	2300
		3,000	40 min	35 min	--	--	--	--	--				
S445 Motor Available for: S24	Recommended	2,500	--	60 min	40 min	35 min	--	--	--	--	125	Roller Vane	520
		3,000	--	50 min	30 Min	30 Min	--	--	--				
S545 Motor Available for: S24	Recommended	2,500	--	--	40 min	35 min	25 min	20 min	--	--	130	Roller Vane	700
		3,000	--	--	30 Min	30 Min	20 Min	16 Min	--				
S645 Motor Available for: S28	Recommended	2,500	--	--	--	40 min	25 Min	15 Min	12 Min	10 Min	130	Roller Vane	540
		3,000	--	--	--	40 min	25 Min	15 Min	12 Min	10 Min			
S540 Motor Available for: S40	Required	2,500	--	--	30 min	15 min	12 min	10 min	--	--	56	Piston	2100
		3,000	--	--	25 min	12 min	10 min	8 min	--				
S570 Motor Available for: S40	Required	2,500	--	--	--	30 min	12 min	10 min	8 min	7 min	84	Piston	2000
		3,000	--	--	--	25 min	10 min	8 min	7 min	6 min			

*Motors will run at this PSI, but excess pressure is dumping over relief.
5 GPM is used for swing cylinder.

STUMP GRINDERS

DEDICATED EXCAVATOR

FREE
6 Pack ^{of REPLACEMENT}
Teeth
WITH PURCHASE
SEE ONLINE FOR DETAILS



PRODUCT FEATURES

- Concave shaped carbide tipped green teeth
- High number of teeth means they last longer
- Bent axis piston motor
- More tooth clearance for better performance
- Chain curtain blast shield
- Heavy duty steel rotor

Visit baumalight.com for additional product information and product videos.

EXCAVATOR MOUNT MODELS

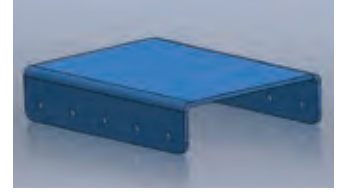

GXM350

1.5-4.5 ton Recommended Carrier Size
High Efficiency Bent Axis Piston Motor
Check motor options for Hydraulic GPM
19" Rotor Size
Cutting Wheel Speed Depends on GPM
No limit Cutting Height - Above Ground
16" Cutting Depth - Below Ground
3/4" Maximum Cutting Depth - Per Pass
12" Maximum Horizontal Cut
Relieve valve Over Torque Protection
Bolt on adapter
1 remote required - hydraulic
12 Volt DC not required
650 Lbs (shipping)
Replacement Teeth: W3000 Wearsharp®*
16 Teeth

\$6,120 (X508 motor)
\$6,320 (X510 motor)
\$6,760 (X530 motor)

Adapter sold separately.
Hoses and couplers NOT included.

GXM550

3.5 - 8 ton Recommended Carrier Size
High Efficiency Bent Axis Piston Motor
Check motor options for Hydraulic GPM
24" Rotor Size
Cutting Wheel Speed Depends on GPM
No limit Cutting Height - Above Ground
24" Cutting Depth - Below Ground
1" Maximum Cutting Depth - Per Pass
22" Maximum Horizontal Cut
Relieve valve Over Torque Protection
Bolt on adapter
1 remote required - hydraulic
12 Volt DC not required
822 Lbs (shipping)
Replacement Teeth: W3000 Wearsharp®*
20 Teeth

\$7,480 (X510 motor)
\$7,680 (X510 motor)
\$8,120 (X530 motor)
\$8,320 (X540 motor)
\$8,360 (X550 motor)

Adapter sold separately.
Hoses and couplers NOT included.

GXM750

7 - 18 ton Recommended Carrier Size
High Efficiency Bent Axis Piston Motor
Check motor options for Hydraulic GPM
24" Rotor Size
Cutting Wheel Speed Depends on GPM
No limit Cutting Height - Above Ground
24" Cutting Depth - Below Ground
1" Maximum Cutting Depth - Per Pass
22" Maximum Horizontal Cut
Relieve valve Over Torque Protection
Bolt on adapter
1 remote required - hydraulic
12 Volt DC not required
1300 Lbs (shipping)
Replacement Teeth: W3000 Wearsharp®*
20 Teeth

\$9,120 (X540 motor)
\$9,160 (X550 motor)
\$10,080 (X570 motor)
\$10,960 (X590 motor)

Adapter sold separately.
Hoses and couplers NOT included.

EXCAVATOR ADAPTER

D001161
Blank Weld-on Plate
Bolt on Connection
48 lbs
See the back of the catalog for pricing
and our turn-key mounting options.

*See front of the catalog for teeth details and pricing



EXCAVATOR STUMP CUTTING TIMES BASED ON 24" STUMP

MOTOR	CASE DRAIN	PSI	12 GPM	15 GPM	20 GPM	25 GPM	30 GPM	35 GPM	40 GPM	50 GPM	60 GPM	CC	MOTOR TYPE	RPM AT MAX GPM
X508 Motor Available for: GXM350, GXM550	Critical	3,000	25 min	20 min	--	--	--	--	--	--	--	25	Piston	2300
		4,000	20 min	15 min	--	--	--	--	--	--	--			
X510 Motor Available for: GXM350, GXM550	Critical	3,000	25 min	15 min	8 min	7 min	--	--	--	--	--	34	Piston	4290
		4,000	20 min	10 min	7 Min	5 Min	--	--	--	--	--			
X530 Motor Available for: GXM350, GXM550	Critical	3,000	--	16 min	8 min	7 min	7 min	--	--	--	--	47	Piston	2100
		4,000	--	11 min	7 Min	5 Min	5 min	--	--	--	--			
X540 Motor Available for: GXM550, GXM750	Critical	3,000	--	--	8 min	7 min	6 min	5 min	--	--	--	65	Piston	2100
		4,000	--	--	7 min	5 min	5 min	4 min	--	--	--			
X550 Motor Available for: GXM550, GXM750	Critical	3,000	--	--	--	7 min	6 min	5 min	4 min	--	--	64	Piston	2140
		4,000	--	--	--	5 min	5 min	4 min	3 min	--	--			
X570 Motor Available for: GXM750	Critical	3,000	--	--	--	--	7 min	6 min	4 min	3 min	--	84	Piston	2000
		4,000	--	--	--	--	6 min	4 min	3 min	3 min	--			
X590 Motor Available for: GXM750	Critical	3,000	--	--	--	--	--	--	5 min	3 min	3 min	108	Piston	1900
		4,000	--	--	--	--	--	--	3 min	3 min	2 min			

STUMP GRINDERS

MULTI CARRIER

FREE
6 Pack of REPLACEMENT
TEETH
WITH PURCHASE
SEE ONLINE FOR DETAILS



PRODUCT FEATURES

- Mounted on either Skidsteer or Excavator
- High number of teeth means they last longer
- All available hydraulic power goes to Hydraulic Motor
- Very few moving parts
- Simple design for simple maintenance

Visit baumalight.com for additional product information and product videos.

MULTI CARRIER MOUNT MODELS



S14

Skidsteer Mount Specs:

12-30 Recommended HP
Check GPM & PSI for Max. Carrier Size
Check Stump Cutting Size Chart for Hydraulic GPM

Excavator Mount Specs:

1-2 Ton Recommended Carrier Size
Check Motor Options for Hydraulic GPM

Gerotor Motor
18" Rotor Size
Cutting Wheel Speed Depends on GPM
No limit Cutting Height - Above Ground
6" Cutting Depth - Below Ground
2" Maximum Cutting Depth - Per Pass
12" Maximum Horizontal Cut
Self-feeding Swing Arc
150 Ft.-Lbs. Hub Torque
Relieve valve Over Torque Protection
1" Pivot Pins Hitch
1 Remotes Required - Hydraulic
Doesn't Require 12 Volt DC
394 Lbs Unit Weight (Shipping)
Replacement Teeth: W3000 Wearsharp®*
12 Teeth

\$2,940 (S250 motor) Adapter sold separately.
\$3,280 (S450 motor) Hoses & couplers included.

*See front of the catalog for teeth details and pricing



S18

Skidsteer Mount Specs:

25-80 Recommended HP
Check GPM & PSI for Max. Carrier Size
Check Stump Cutting Size Chart for Hydraulic GPM

Excavator Mount Specs:

1.5-4 Ton Recommended Carrier Size
Check Motor Options for Hydraulic GPM

Gerotor Motor
24" Rotor Size
Cutting Wheel Speed Depends on GPM
No limit Cutting Height - Above Ground
10" Cutting Depth - Below Ground
5" Maximum Cutting Depth - Per Pass
22" Maximum Horizontal Cut
Self-feeding Swing Arc
250 Ft.-Lbs. Hub Torque
Relieve valve Over Torque Protection
1" Pivot Pins Hitch
1 Remotes Required - Hydraulic
Doesn't Require 12 Volt DC
642 Lbs Unit Weight (Shipping)
Replacement Teeth: S1000*
34 Teeth

\$4,360 (S450 motor) Adapter sold separately.
\$4,592 (S550 motor) Hoses included.
\$4,980 (S650 motor) Couplers NOT included for high flow.

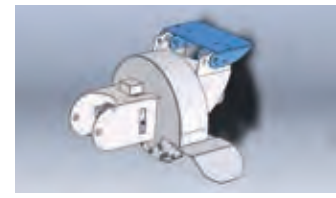

EXCAVATOR ADAPTORS

Weld-on excavator adapter for S14 or S18.

D002112
Unpainted & Not welded
\$104

D001421
Painted & Welded
\$280

See the back of the catalog for our turn-key mounting options.

SKIDSTEER ADAPTORS

D001126	S14 or S18 Mini Skid Steer Attachment	1" Pivot Pin	60 lbs	\$120
D001943	S14 or S18 Bob Cat Mini Skid Steer Attachment (35.5" wide)	1" Pivot Pin	60 lbs	\$220
D001127	S14 or S18 Universal Skid Steer Attachment	1" Pivot Pin	60 lbs	\$200
D003504	S14 or S18 ASV & Terex RC30 & PT30 Skid Steer Plate			\$



STUMP CUTTING TIMES BASED ON 24" STUMP

MOTOR	CASE DRAIN	PSI	12 GPM	15 GPM	20 GPM	25 GPM	30 GPM	35 GPM	40 GPM	CC	MOTOR TYPE	RPM AT MAX GPM
S250 Motor Available for: S14	Not required	2,500	50 min	40 min	--	--	--	--	--	50	Roller Vane	910
		3,000	40 min	35 min	--	--	--	--				
S450 Motor Available for: S14, S18	Not required	2,500	60 min	40 min	35 min	--	--	--	--	125	Roller Vane	520
		3,000	50 min	30 Min	30 Min	--	--	--				
S550 Motor Available for: S18	Recommended	3,000	--	30 Min	25 Min	20 min	16 min	--	--	130	Roller Vane	700
		3,500	--	30 Min	25 Min	20 min	16 min	--				
S650 Motor Available for: S18	Recommended	3,000	--	--	40 min	25 min	15 min	12 min	10 min	245	Roller Vane	540
		3,500	--	--	40 min	25 min	15 min	12 min	10 min			

*Motor will run at this PSI but excess pressure is dumping over relief.

STUMP GRINDERS

ALTERNATIVE MODELS

FREE
6 Pack ^{of REPLACEMENT}
TEETH
WITH PURCHASE
SEE ONLINE FOR DETAILS



ALTERNATIVE MODELS



8 WEEKS \$ SAVES \$ 8%



WB44 WALK BEHIND

- 13 HP-Honda GX390 389cc Motor
- 13" Cutting Wheel
- 2 Band V-Belt Drive
- Manual Walk Behind Wheel Drive
- Centrifugal Clutch
- 15" Tires
- 80" Length
- 29.75" Width
- 370 Lbs Unit Weight (Shipping)
- Replacement Teeth: W3000 Wearsharp®*
- 12 Teeth

\$4,560

*See front of the catalog for teeth details and pricing

HGW30 SELF-PROPELLED

- 30 HP-Kohler 999cc Motor
- 19" Rotor Size
- Cutting Wheel Speed 1800 RPM
- 28" Height - Above Ground
- 12" Cutting Depth - Below Ground
- 3" Maximum Cutting Depth - Per Pass
- 46" Maximum Horizontal Cut
- 85° Swing Arc
- Relieve valve Over Torque Protection
- 3300 RPM input speed
- Manual Control
- 2-wheel Drive
- 105" Length
- 35" Width
- 1820 Lbs Unit Weight (Shipping)
- 2195 Lbs Unit Weight - with Optional Weight Kit (Shipping)
- Replacement Teeth: W3000 Wearsharp® *
- 16 Teeth

8 WEEKS \$ SAVES \$ 8%

\$18,368

\$16,899

*See front of the catalog for teeth details and pricing
D003888 Weight kit **\$716.80**

HGS50F CHRISTMAS TREE STUMP GRINDER

- 20-42 GMP Motor
- 90 HP bevel gearbox
- 36 carbide tipped cutting teeth
- 6" wide rotor
- Nylon wrapping hoses for extra protection
- Heavy Duty frame
- Angled skidsteer plate for better visibility
- Powder coated finish and crated to ship
- Anti-slip safety pads on step
- Chain curtain to contain flying chip
- Replacement Teeth: S1000*
- 28 teeth

\$6,360

*See front of the catalog for teeth details and pricing

AVAILABLE OPTIONS

TRACTOR MODEL EXTERNAL CONTROL

PART# S1050

This optional control is mounted on an adjustable arm. The control is great for smaller tractors with limited HP for better cutting control and required for tractors with only one remote. Recommended for improved feathering control on smaller tractors.

Not available for 1P24

\$680 (if ordered with stump grinder)

\$930 (if ordered separately, a complete new hose set is required)



SCREW SPLITTERS STUMP PLANERS



PRODUCT FEATURES

- Heavy duty construction with a durable powder coat finish
- Easy to change bits from screw splitter to stump planer
- Hydraulically-driven planetary drive up to 11,000 ft./lbs. of torque
- No 12V electrical connection required
- Flange protects the main shaft seal to prevent damage from debris
- Hardened replaceable entry tip for extra-long life

Visit baumalight.com for additional product information and product videos.



SOLD BY
EQUIPMENT DEALERS
FOR LOCAL SUPPORT

SKIDSTEER MOUNT MODELS



RSS380

Skidsteer: 4000 lbs. (Max)
Rec. GPM: 15-40
Max GPM: 45
Rec. PSI: 2500-3000
Max PSI: 3500
2" Hex Planetary Drive
Hoses Included*

\$4,688 (Drive Only, Bits Extra)

*Hoses included on Skidsteer models, but no couplers.



RSS580

Skidsteer: 6000 lbs. (Max)
Rec. GPM: 15-40
Max GPM: 45
Rec. PSI: 2500-3000
Max PSI: 3500
2" Hex Planetary Drive
Hoses Included*

\$4,960 (Drive Only, Bits Extra)



RSS780

Skidsteer: 10,000 lbs. (Max)
Rec. GPM: 20-55
Max GPM: 65
Rec. PSI: 2500-4500
Max PSI: 5000
8 Bolt Flange Planetary Drive
Hoses Included* (Case drain critical)

\$8,640 (Drive Only, Bits Extra)

EXCAVATOR MOUNT MODELS

RSX380

Bolt-on Adaptor
Excavator: 3 Ton (Max)
Rec. GPM: 15-40
Max GPM: 45
Rec. PSI: 2500-3000
Max PSI: 3500
2" Hex Planetary Drive
Hoses Not Included

\$4,480 (Drive Only, Bits Extra)



RSX580

Bolt-on Adaptor
Excavator: 8 Ton (Max)
Rec. GPM: 15-40
Max GPM: 45
Rec. PSI: 2500-3000
Max PSI: 3500
2" Hex Planetary Drive
Hoses Not Included

\$4,784 (Drive Only, Bits Extra)



RSX780

Bolt-on Adaptor
Excavator: 18 Ton (Max)
Rec. GPM: 20-55
Max GPM: 65
Rec. PSI: 2500-4500
Max PSI: 5000
8 Bolt Flange Planetary Drive
Hoses Not Included

\$8,400 (Drive Only, Bits Extra) [Case drain critical]



SCREW SPLITTER TOOLS



MODEL	DESCRIPTION	PRICE
D002507	2" Hex 14x8 splitter cone assembly with replaceable tip	\$960
D003935	8-bolt flange mount 14x8 splitter cone assembly with replaceable tip	\$1,040
D002506	Splinter Tip - Hardened 4140 40/45RC for D002507 & D003935	\$312

FLOW & PRESSURE SPECIFICATIONS

RSS380, RSS580, RSX380, RSX580

GPM	2,000 PSI	2,500 PSI	3,000 PSI	3,500 PSI
20	45	2,294	43	2,870
24	54	2,289	51	2,879
28	63	2,281	61	2,870
32	72	2,243	70	2,841
40	90	2,167	87	2,769

■ RPM ■ Foot Pounds Torque Case Drain: Good to Have

RSS780, RSX780

GPM	3,000 PSI	3,300 PSI	4,000 PSI
20	19	8,424	19
25	24.7	8,424	24.7
30	29.6	8,424	29.6
40	39	8,424	39
50	49	8,424	49
60	59	8,424	59
70	69	8,424	69

■ RPM ■ Foot Pounds Torque Case Drain: Crucial

STUMP PLANER TOOLS



MODEL	DESCRIPTION	PRICE
D002771	2" Hex 20" dia. 4-knife stump planer	\$1,000
D003381	8-bolt flange mount stump planer	\$1,480
D003508	Planer Spiral Tip - 4140 40/45RC for D002771 & D003381	\$280
D003930	Small blade assembly for D002771 Planer	\$360
D003434	Small Blade Assembly for D003381 Planer	\$440

TREE SHEARS

SKIDSTEER



PRODUCT FEATURES

- Blades built with durable AR400 steel
- Greasable pins on all pivot points
- Hardened steel bushings
- Flexible hose support and double shielded hoses
- Push bar to control where trees fall
- AUX In-cab control available (rotating models only)

Visit baumalight.com for additional product information and product videos.

SKIDSTEER ROTATING & VERTICAL MODELS



ISR 90° ROTATE SERIES



ISV VERTICAL SERIES

ISR MODEL SPECIFICATIONS

MODEL	CARRIER	BLADE ANGLE	WEIGHT CLASS	LIMB SIZE	GPM	PRICE
ISR508	Skidsteer	Rotating	3,000 - 6,000	8	5-40	\$5,400
ISR510	Skidsteer	Rotating	4,000 - 7,000	10	10-50	\$5,800
ISR512	Skidsteer	Rotating	5,000 - 8,000	12	15-60	\$6,280

ISV MODEL SPECIFICATIONS

MODEL	CARRIER	BLADE ANGLE	WEIGHT CLASS	LIMB SIZE	GPM	PRICE
ISV508	Skidsteer	Vertical	3,000 - 6,000	8	5-40	\$2,800
ISV510	Skidsteer	Vertical	4,000 - 7,000	10	10-50	\$3,600
ISV512	Skidsteer	Vertical	5,000 - 8,000	12	15-60	\$4,120

TREE SIZE CUTTING PERFORMANCE

MODEL	WOOD TYPE	2000 PSI	2500 PSI	2800 PSI	3000 PSI	3400 PSI	4000 PSI
ISR508	Hardwood	N/A	3"	5"	6"	7"	8"
	Softwood	3"	5"	6"	7"	8"	8"
ISR510	Hardwood	N/A	4"	7"	8"	9"	10"
	Softwood	4"	7"	8"	9"	10"	10"
ISR512	Hardwood	N/A	5"	9"	10"	11"	12"
	Softwood	5"	9"	10"	11"	12"	12"
ISV308	Hardwood	N/A	4"	5"	6"	7"	8"
	Softwood	2"	5"	6"	7"	8"	8"
ISV510	Hardwood	N/A	4"	7"	8"	9"	10"
	Softwood	3"	5"	8"	9"	10"	10"
ISV512	Hardwood	N/A	5"	9"	10"	11"	12"
	Softwood	5"	9"	10"	11"	12"	12"

SKIDSTEER HORIZONTAL MODELS



**ISH HORIZONTAL
500 SERIES**



**ISH HORIZONTAL
600 SERIES**



**ISH HORIZONTAL
700 SERIES**

ISH MODEL SPECIFICATIONS

MODEL	CARRIER	BLADE ANGLE	WEIGHT CLASS	LIMB SIZE	GRABBER	GPM	PRICE
ISH508	Skidsteer	Horizontal	3,000 - 6,000	8	No	5-40	\$3,000
ISH510	Skidsteer	Horizontal	4,000 - 7,000	10	No	10-50	\$3,996
ISH512	Skidsteer	Horizontal	5,000 - 8,000	12	No	15-60	\$4,200
ISH508G	Skidsteer	Horizontal	3,000 - 6,000	8	Yes	5-40	\$4,120
ISH510G	Skidsteer	Horizontal	4,000 - 7,000	10	Yes	10-50	\$4,680
ISH512G	Skidsteer	Horizontal	5,000 - 8,000	12	Yes	15-60	\$5,080
ISH610G	Skidsteer	Horizontal	4,000 - 7,000	10	Yes	10-50	\$5,960
ISH612G	Skidsteer	Horizontal	5,000 - 8,000	12	Yes	15-60	\$6,720
ISH712G	Skidsteer	Horizontal	6,000 - 12,000	12	Yes	15-60	\$10,360

TREE SIZE CUTTING PERFORMANCE

MODEL	WOOD TYPE	2000 PSI	2500 PSI	2800 PSI	3000 PSI	3400 PSI	4000 PSI
ISH508	Hardwood	N/A	3"	5"	6"	7"	8"
	Softwood	3"	5"	6"	7"	8"	8"
ISH510	Hardwood	N/A	4"	7"	8"	9"	10"
	Softwood	4"	7"	8"	9"	10"	10"
ISH512	Hardwood	N/A	5"	9"	10"	11"	12"
	Softwood	5"	9"	10"	11"	12"	12"
ISH308G	Hardwood	N/A	3"	5"	6"	7"	8"
	Softwood	3"	5"	6"	7"	8"	8"
ISH510G	Hardwood	N/A	4"	7"	8"	9"	10"
	Softwood	4"	7"	8"	9"	10"	10"
ISH512G	Hardwood	N/A	5"	9"	10"	11"	12"
	Softwood	5"	9"	10"	11"	12"	12"
ISH610G	Hardwood	N/A	7"	8"	9"	10"	10"
	Softwood	7"	8"	9"	10"	10"	10"
ISH612G	Hardwood	N/A	9"	10"	11"	12"	12"
	Softwood	9"	10"	11"	12"	12"	12"
ISH712G	Hardwood	8"	10"	11"	12"	12"	12"
	Softwood	10"	11"	12"	12"	12"	12"

TREE PULLERS

SKIDSTEER

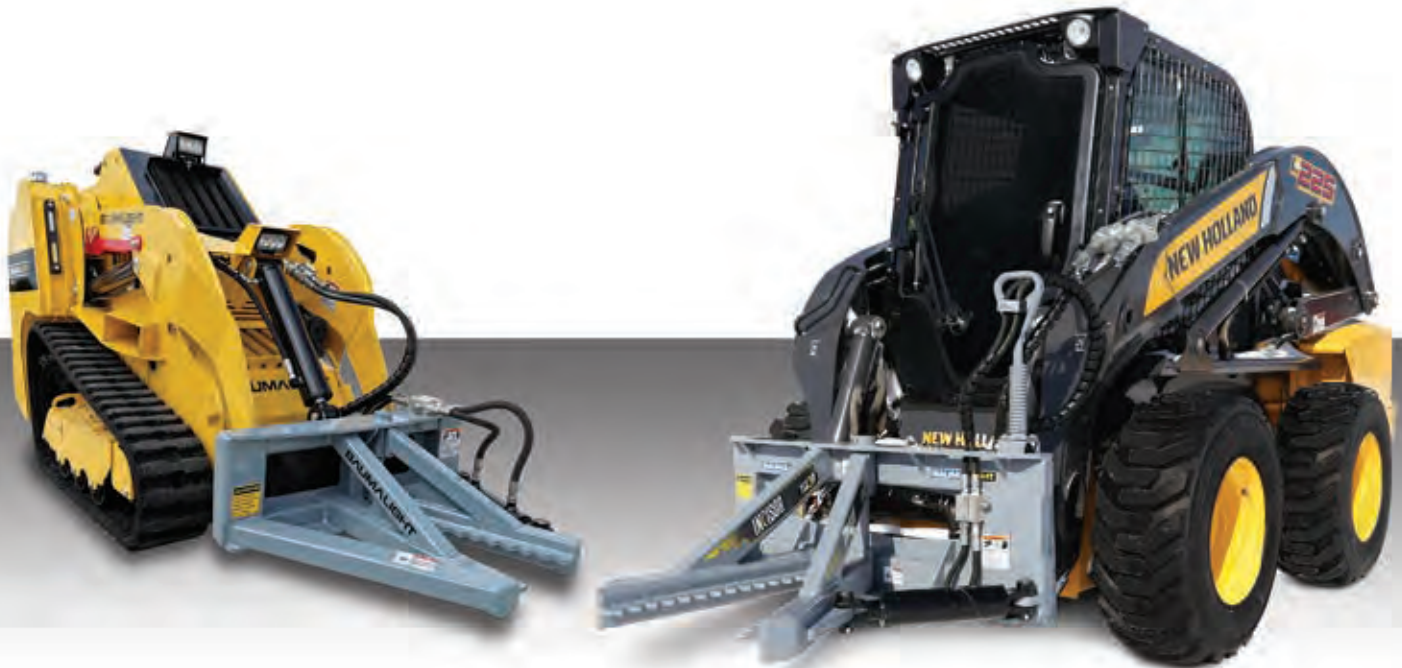

PRODUCT FEATURES

- Cross over relief to protect over pressurizing
- Standard flat faced hydraulic couplers included
- Nylon wrapped hoses
- Spring mounted strain relief hose holder prevents pinching, but allows full forward curl
- Anti-slip safety step pads

Visit baumalight.com for additional product information and product videos.



ISH3M MINI SKIDSTEER



ISH3P SKIDSTEER



ISH3S SKIDSTEER

ISH TREE PULLER MODEL SPECIFICATIONS

MODEL	CARRIER	LIMB SIZE	CYLINDER SIZE	PIN DIAMETER	SHIPPING SIZE	SKIDSTEER SIZE RANGE	PRICE
ISH3M	Mini Skidsteer	2"	2" Bore	1"	33" x 28" x 15"	1,500 - 4,000 lbs	\$1,516
ISH3P	Skidsteer	4"	3" Bore	1.5"	40" x 50" x 21"	4,000 - 8,000 lbs	\$1,720
ISH3S	Skidsteer	3"	3" Bore	1.5"	62" x 35" x 42"	3,500 - 8,000 lbs	\$1,700

TREE SHEARS

EXCAVATOR - ROTATING

EXCAVATOR

MOUNTING

**WELD-ON & TURN-KEY
EXCAVATOR MOUNTING
OPTIONS AVAILABLE!**

SEE BACK OF CATALOG FOR DETAILS.

PRODUCT FEATURES

- Blades built with durable AR400 steel
- Greasable pins on all pivot points
- Hardened steel bushings
- Grabber arms to securely handle sheared limbs (G models only)
- 180 degree helical rotary actuator (IXA models only)

Visit baumalight.com for additional product information and product videos.

EXCAVATOR ROTATING MODELS



**IXP 90° ROTATE
300 & 500 SERIES**



**IXP 90° ROTATE
700 SERIES**



**IXA 180° ROTATE
500 SERIES**



**IXA 180° ROTATE
700 SERIES**

IXP MODEL SPECIFICATIONS

MODEL	CARRIER	BLADE ANGLE	WEIGHT CLASS	LIMB SIZE	GRABBER	GPM	PRICE
IXP308G	Excavator	Pivoting	3-10 ton	8	Yes	5-40	\$5,800 *
IXP510G	Excavator	Pivoting	5-15 ton	10	Yes	10-15	\$6,680 *
IXP512G	Excavator	Pivoting	8-20 ton	12	Yes	15-60	\$7,080 *
IXP715G	Excavator	Pivoting	15-26 ton	15	Yes	20-100	\$9,800 *

* Priced without excavator adaptor, hoses and control wire.

IXA MODEL SPECIFICATIONS

MODEL	CARRIER	BLADE ANGLE	WEIGHT CLASS	LIMB SIZE	GRABBER	GPM	PRICE
IXD508G	Excavator	Rotating Actuator	3-10 ton	8	Yes	5-40	\$12,200 *
IXD512G	Excavator	Rotating Actuator	8-20 ton	12	Yes	15-60	\$15,600 *
IXD715G	Excavator	Rotating Actuator	15-26 ton	15	Yes	20-100	\$18,000 *

* Priced without excavator adaptor, hoses and control wire.

TREE SIZE CUTTING PERFORMANCE

MODEL	WOOD TYPE	2000 PSI	2500 PSI	2800 PSI	3000 PSI	3400 PSI	4000 PSI
IXP308G	Hardwood	N/A	3"	5"	6"	7"	8"
	Softwood	3"	5"	6"	7"	8"	8"
IXP510G	Hardwood	N/A	4"	7"	8"	9"	10"
	Softwood	4"	7"	8"	9"	10"	10"
IXP512G	Hardwood	N/A	5"	9"	10"	11"	12"
	Softwood	5"	9"	10"	11"	12"	12"
IXP715G	Hardwood	10"	11"	12"	13"	14"	15"
	Softwood	11"	12"	13"	14"	15"	15"
IXA508G	Hardwood	N/A	3"	5"	6"	7"	8"
	Softwood	3"	5"	6"	7"	8"	8"
IXA512G	Hardwood	N/A	5"	9"	10"	11"	12"
	Softwood	5"	7"	10"	11"	12"	12"
IXA715G	Hardwood	10"	11"	12"	13"	14"	15"
	Softwood	11"	12"	13"	14"	15"	15"

TREE SHEARS

EXCAVATOR - VERTICAL

EXCAVATOR

MOUNTING

**WELD-ON & TURN-KEY
EXCAVATOR MOUNTING
OPTIONS AVAILABLE!**

SEE BACK OF CATALOG FOR DETAILS.

PRODUCT FEATURES

- Blades built with durable AR400 steel
- Greasable pins on all pivot points
- Hardened steel bushings
- Customized stiff brace for added strength
- Laser cut teeth give the jaws a powerful grip
- No additional hydraulic hoses are required

Visit baumalight.com for additional product information and product videos.

EXCAVATOR VERTICAL MODELS



IXV VERTICAL 500 SERIES



IXV VERTICAL 700 SERIES

IXV MODEL SPECIFICATIONS

MODEL	CARRIER	BLADE ANGLE	WEIGHT CLASS	LIMB SIZE	GPM	PRICE
IXV508	Excavator	Vertical	3-10 ton	8	5-40	\$3,600 *
IXV510	Excavator	Vertical	5-15 ton	10	10-15	\$5,240 *
IXV512	Excavator	Vertical	8-20 ton	12	15-60	\$6,040 *
IXV715	Excavator	Vertical	15-26 ton	15	20-100	\$7,960 *

* Priced without excavator adaptor, hoses and control wire.

TREE SIZE CUTTING PERFORMANCE

MODEL	WOOD TYPE	2000 PSI	2500 PSI	2800 PSI	3000 PSI	3400 PSI	4000 PSI
IXV508	Hardwood	2"	5"	6"	7"	7"	7"
	Softwood	3"	6"	7"	8"	8"	8"
IXV510	Hardwood	3"	4"	7"	8"	9"	10"
	Softwood	4"	7"	8"	9"	10"	10"
IXV512	Hardwood	4"	5"	9"	10"	11"	12"
	Softwood	5"	9"	10"	11"	12"	12"
IXV715	Hardwood	10"	11"	12"	13"	14"	15"
	Softwood	11"	12"	13"	14"	15"	15"



TREE SAWS

SKIDSTEER

FREE
6 Pack of REPLACEMENT
TEETH
WITH PURCHASE
SEE ONLINE FOR DETAILS



PRODUCT FEATURES

- 180 degree rotating cutting head (manual or actuator)
- Blade mounted on heavy duty bearing support
- Saw blade shield protects operator from debris
- Hoses are double shielded and then internally routed for protection
- Roll back mount angle for better flexibility
- Angled push bar with protective mesh
- Serrated steel front push bar plate
- Zinc plated greaseable pins to prevent corrosion

Visit baumalight.com for additional product information and product videos.

SKIDSTEER MOUNT MODELS



DSM230

180° Manual Rotation
Mini Skidsteer Connection
Doesn't require 12 V Electric
Hydraulic Hoses Included
Hydraulic Couplers NOT Included
30" Blade Diameter (10" Max Cut)
AR400 Steel Blade
3/4" Cut Thickness
15 Green Teeth with 3 Edges Per Tooth
Replacement Teeth: H3000 High Speed*

\$4,240 (T508G Motor)
\$5,480 (T508 Motor)

DSM530

180° Manual Rotation
Universal Skidsteer Connection
Doesn't require 12 V Electric
Hydraulic Hoses Included
Hydraulic Couplers NOT Included
30" Blade Diameter (10" Max Cut)
AR400 Steel Blade
3/4" Cut Thickness
15 Green Teeth with 3 Edges Per Tooth
Replacement Teeth: H3000 High Speed*

\$5,080 (T508G Motor)
\$6,320 (T508 Motor)
\$5,220 (T530G Motor)
\$7,040 (T530 Motor)

DSA530

180° Actuator Rotation
Universal Skidsteer Connection
Helical Actuator
Requires 1 Positive Pin AUX or 12 V Electric
Hydraulic Hoses Included
Hydraulic Couplers NOT Included
30" Blade Diameter (10" Max Cut)
AR400 Steel Blade
3/4" Cut Thickness
15 Green Teeth with 3 Edges Per Tooth
Replacement Teeth: H3000 High Speed*

\$9,760 (T508G Motor)
\$11,000 (T508 Motor)
\$9,900 (T530G Motor)
\$11,720 (T530 Motor)

*See front of the catalog for teeth details and pricing

MOTOR OPTIONS - DSM230, DSM530 & DSA530

Cutting Time for 10" Limb

MOTOR	MOTOR TYPE	CC	CASE DRAIN	RPM AT MAX GPM	PSI	9 GPM	12 GPM	15 GPM	20 GPM	25 GPM	30 GPM	40 GPM
T508G	Gear	26	Critical	2500	2,500 3,000	50 sec	30 sec	20 sec	15 sec	--	--	--
T508	Piston	25				30 sec	20 sec	15 sec				
T530G	Gear	46	Critical	2600	3,000 4,000	--	--	15 sec	10 sec	8 sec	5 sec	5 sec
T530	Piston	47				10 sec	8 sec	5 sec	5 sec	5 sec		



TREE SAWS

EXCAVATOR

FREE REPLACEMENT
Teeth WITH PURCHASE
SEE ONLINE FOR DETAILS



PRODUCT FEATURES

- 180 degree rotating cutting head - (DXM & DXA models only)
- Blade mounted on heavy duty bearing support
- Saw blade shield protects operator from debris
- Bolt-on excavator adapter mount
- Powder Coated
- Designed with maximum visibility for accurate cuts
- Fast lead time which is shown on our website
- Rotate teeth for double or triple life

Visit baumalight.com for additional product information and product videos.

EXCAVATOR MOUNT MODELS



DXM530

180° Manual Rotation

Doesn't require 12 V Electric
Hydraulic Hoses NOT Included
Hydraulic Couplers NOT Included
30" Blade Diameter (10" Max Cut)
AR400 Steel Blade - 3/4" Cut Thickness
15 Green Teeth with 3 Edges Per Tooth
Replacement Teeth: H3000 High Speed*

- \$4,240 (T508G Motor)
- \$5,480 (T508 Motor)
- \$4,380 (T530G Motor)
- \$6,200 (T530 Motor)

*See front of the catalog for teeth details and pricing

DXA530

180° Actuator Rotation

Helical Actuator
Requires 1 Positive Pin for AUX or 12 V Electric
Hydraulic Hoses NOT Included
Hydraulic Couplers NOT Included
30" Blade Diameter (10" Max Cut)
AR400 Steel Blade - 3/4" Cut Thickness
15 Green Teeth with 3 Edges Per Tooth
Replacement Teeth: H3000 High Speed*

- \$8,920 (T508G Motor)
- \$10,160 (T508 Motor)
- \$9,060 (T530G Motor)
- \$10,880 (T530 Motor)

DXH752

Fixed Horizontal

Doesn't require 12 V Electric
Hydraulic Hoses NOT Included
Hydraulic Couplers NOT Included
52" Blade Diameter (20" Max Cut)
1" Thick Steel Blade - 1-5/8" Cut Thickness
17 Beaver Teeth with 4 Edges Per Tooth
Replacement Teeth: B8000 Beaver Teeth *

- \$18,360 (T550 Motor)
- \$19,280 (T570 Motor)
- \$20,160 (T590 Motor)

MOTOR OPTIONS - DXM530 & DXA530

Cutting Time for 10" Limb

MOTOR	MOTOR TYPE	CC	CASE DRAIN	RPM AT MAX GPM	PSI	9 GPM	12 GPM	15 GPM	20 GPM	25 GPM	30 GPM	40 GPM
T508G	Gear	26	Critical	2500	2,500 3,000	50 sec	30 sec	20 sec	15 sec	--	--	--
T508	Piston	25				30 sec	20 sec	15 sec	10 sec	--	--	--
T530G	Gear	46	Critical	2600	3,000 4,000	--	--	15 sec	10 sec	8 sec	5 sec	5 sec
T530	Piston	47				10 sec	8 sec	5 sec	5 sec	5 sec	5 sec	

MOTOR OPTIONS - DXH752

Cutting Time for 20" Limb

MOTOR	MOTOR TYPE	CC	CASE DRAIN	RPM AT MAX GPM	PSI	20 GPM	25 GPM	30 GPM	35 GPM	40 GPM	50 GPM	60 GPM
T550	Piston	64	Critical	2140	3,000 4,000	--	20 sec 10 sec	10 sec 8 sec	8 sec 5 sec	8 sec 5 sec	--	--
T570	Piston	84	Critical	2000	3,000 4,000	--	--	15 sec 10 sec	10 sec 5 sec	5 sec 5 sec	5 sec 5 sec	--
T590	Piston	108	Critical	1900	3,000 4,000	--	--	--	--	8 sec 5 sec	5 sec 5 sec	5 sec 5 sec



WELD-ON & TURN-KEY EXCAVATOR MOUNTING OPTIONS AVAILABLE!

SEE BACK OF CATALOG FOR DETAILS.



TREE SAWS

TRACTOR

FREE
6 Pack of REPLACEMENT
TEETH
WITH PURCHASE
SEE ONLINE FOR DETAILS



PRODUCT FEATURES

- Durable powder coated protective finish
- Handy pusher bar to guide falling trees
- Heavy duty gearbox delivers a smooth transfer of power
- A slip clutch protects the gearbox and drive system from over torquing
- Rotatable teeth with 3 edges
- Bolt-on blade direct to gearbox
- Designed to cut close to the ground
- Simple and rugged design

Visit baumalight.com for additional product information and product videos.

TRACTOR MOUNT MODELS



DPH530

50 Hp Maximum Engine
40 Hp Maximum PTO

- CAT 1 3-point hitch
- Quick Hitch Compatible: Yes
- Fixed Horizontal Blade
- 540 Drive Shaft
- Slip clutch Gearbox protection
- 30" Blade Diameter (10" Max Cut)
- AR400 Blade Material
- 3/4" Cut Thickness
- 15 Green Teeth with 3 Edges Per Tooth
- Replacement Teeth: H3000 High Speed*

\$4,792.00

DPH735

85 Hp Maximum Engine
75 Hp Maximum PTO

- CAT 2 3-point hitch
- Quick Hitch Compatible: No
- Fixed Horizontal Blade
- 540 Drive Shaft
- Slip clutch Gearbox protection
- 35" Blade Diameter (12" Max Cut)
- Steel Blade Material
- 1-5/8" Cut Thickness
- 12 Beaver Teeth with 4 Edges Per Tooth
- Replacement Teeth: B8000 Beaver Teeth*

\$7,040.00

*See front of the catalog for teeth details and pricing

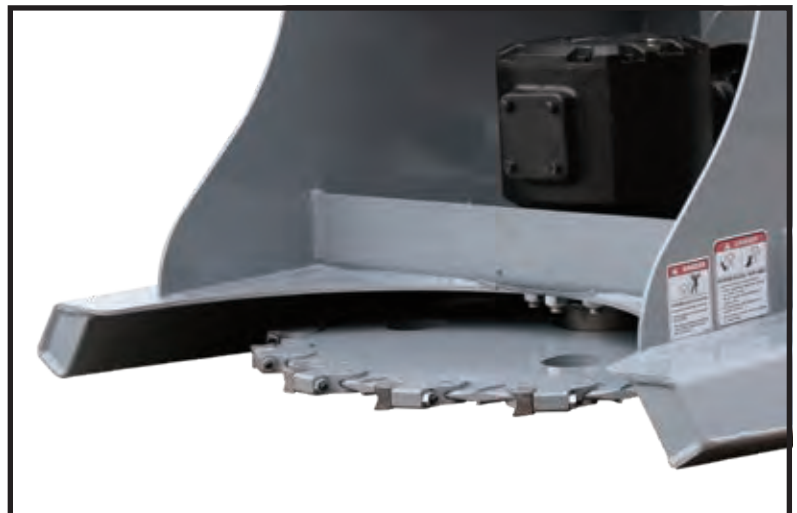

FELLER BUNCHERS

SKIDSTEER / EXCAVATOR



PRODUCT FEATURES

- 52 inch cutting disc
- Cuts up to 20" trees
- 18 sharpenable teeth
- Powder coat finish
- Grabber arms secure trees and allow you to place where you want
- Double shielded hoses on skidsteer model
- Bunching arm to accumulate multiple small trees
- AUX plug in option

Visit baumalight.com for additional product information and product videos.

SKIDSTEER / EXCAVATOR MODELS



SKIDSTEER MOUNTED MODEL

FBS752

Skidsteer Mounted Fixed Horizontal Blade
 Universal Skidsteer Adaptor
 4000 PSI
 Requires 12 V Electric
 Four 12V positive signals required
 Wire Supplied to AUX on boom
 Hoses Included. Couplers NOT Included
 52" Diameter Blade
 20" Max Cut
 36" Throat Opening
 Throat Opening at teeth: 36"
 1" Steel Blade/ 1 5/8" Cut Thickness
 2500 lbs
 4 Edges Per Tooth
 18 Teeth
 B8000 Beaver Teeth
\$23,840 (T570 Motor)
\$25,200 (T590 Motor)

FBXH752

Excavator Mounted Fixed Horizontal Blade
 Bolt-on Adaptor
 4000 PSI
 Requires 12 V Electric
 Four 12V positive signals required
 Wire & Plug NOT Supplied
 Hoses & Couplers NOT Included
 52" Diameter Blade
 20" Max Cut
 36" Throat Opening
 1" Steel Blade
 1 5/8" Cut Thickness
 4 Edges Per Tooth
 18 Teeth
 B8000 Beaver Teeth
\$25,440 (T570 Motor)
\$26,800 (T590 Motor)

Optional Hand Control

If you don't have AUX, available hand control connects to the 14 pin plug on FBS752.

\$380 (D004956)

*See front of the catalog for teeth details and pricing

MOTOR OPTIONS

MOTOR	MOTOR TYPE	CC	CASE DRAIN	IDEAL RPM	20 GPM	25 GPM	30 GPM	35 GPM	40 GPM	45 GPM
T570	Bent Axis Piston	84	Critical	800 - 1000	800 RPM	1000 RPM	1020 RPM	1220 RPM	--	
T590	Bent Axis Piston	108	Critical	800 - 1200	--	--	800 RPM	950 RPM	1100 RPM	1260 RPM

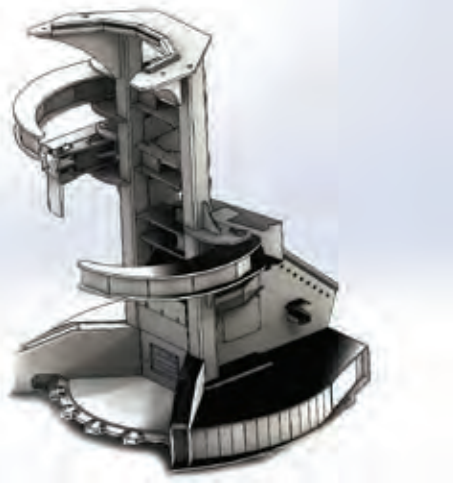

EXCAVATOR MOUNTED MODEL

FBXP752

Excavator Mounted 90° Pivot Blade (Flat to Left)
 Bolt-on Adaptor
 Cylinder Actuator
 4000 PSI
 Requires 12 V Electric
 Four 12V positive signals required
 Wire & Plug NOT Supplied
 Hoses & Couplers NOT Included
 52" Diameter Blade
 20" Max Cut
 36" Throat Opening
 1" Steel Blade
 1 5/8" Cut Thickness
 4 Edges Per Tooth
 18 Teeth
 B8000 Beaver Teeth
\$27,040 (T570 Motor)
\$28,400 (T590 Motor)

FBXD752

Excavator Mounted 180° Rotation with Slew Drive (Left - Flat - Right)
 Bolt-on Adaptor
 Helical Actuator
 4000 PSI
 Requires 12 V Electric
 Four 12V positive signals required
 Wire & Plug NOT Supplied
 Hoses & Couplers NOT Included
 52" Diameter Blade
 20" Max Cut
 36" Throat Opening
 1" Steel Blade
 1 5/8" Cut Thickness
 4 Edges Per Tooth
 18 Teeth
 B8000 Beaver Teeth
\$30,240 (T570 Motor)
\$31,600 (T590 Motor)



WELD-ON & TURN-KEY EXCAVATOR MOUNTING OPTIONS AVAILABLE!

SEE BACK OF CATALOG FOR DETAILS.



ROTARY BRUSH MOWERS

TRACTOR



PRODUCT FEATURES

- Two cuts per pass for each blade
- PTO Shaft with Slip Disk Clutch for Gearbox protection
- Heavy duty chain curtain reduces discharge debris
- 1/4" deck thickness and powercoat finish
- Shield protects the output shaft from impact or contamination by debris
- Open front with push bar for extra control of felling trees

Visit baumalight.com for additional product information and product videos.

TRACTOR MOUNT MODELS



CP560

Open Front with Push Bar
Chain Curtain Protection on Back
70" Path Width
60" Cutting Width
Cuts as low as 2.5"
4 Blades
52 Slashes per Second
CAT 2 3PH
Quick Hitch Compatible: No
75 HP Engine Maximum
65 HP PTO Maximum
4000 lb. Minimum Carrier Weight
2-Disk Clutch System Protection
1/4" Steel Deck Structure
1600 lbs.

\$5,440.00

CP572

Open Front with Push Bar
Chain Curtain Protection on Back
82" Path Width
72" Cutting Width
Cuts as low as 2.5"
4 Blades
52 Slashes per Second
CAT 2 3PH
Quick Hitch Compatible: No
85 HP Engine Maximum
75 HP PTO Maximum
5000 lb. Minimum Carrier Weight
4-Disk Clutch System Protection
1/4" Steel Deck Structure
1900 lbs.

\$6,240.00

ROTARY BRUSH MOWER WEAR PARTS

PART #	DESCRIPTION	CARRIER	CLASS/MODEL	PRICE
D001041	CF/CP Series Swing Blade (per pc)	Skidsteer & 3-Point Hitch	CF/CP	\$34.80
D001275	1" Castle Nut for Swing Blade	Skidsteer & 3-Point Hitch	CF/CP	\$4.80
D001276	1" Blade bolt with Cross hole for Swing blade	Skidsteer & 3-Point Hitch	CF/CP	\$12.80
D001779	1" hardened washer for swing blade	Skidsteer & 3-Point Hitch	CF/CP	\$1.60
D001866	Cotter Pin for swing blade Bolt	Skidsteer, 3-Point Hitch & Excavator	CF/CP	\$1.60
D003970	CXC530 Swing Blade	Excavator	CXC530	\$28.40
D004325	CXC542 Swing Blade	Excavator	CXC542	\$28.40
D003014	CXC550 Swing Blade	Excavator	CXC550	\$42.00
D002543	1" Step Bolt for Swing Blade	Excavator	All 500	\$35.60
D003397	1" Nut for Step bolt	Excavator	All 500	\$18.00

See Tooth Options page at front of catalogue for 700 series mulcher teeth & accessories

ROTARY BRUSH MOWERS

SKIDSTEER



PRODUCT FEATURES

- Two cuts per pass for each blade
- Gear box prevents cutting stress from being passed to the drive motor
- Hose armour prevents damage to hoses by falling brush or trees
- 4-way blade assembly provides up to 52 slashes per second(only applies to 500 Series)
- Shield protects the output shaft from impact or contamination by debris
- Open front with push bar for extra control of felling trees(only applies to 500 Series)

Visit baumalight.com for additional product information and product videos.

SKIDSTEER MOUNT MODELS



CF360

Chain Curtain Protection on Front and Back
 70" Path Width
 60" Cutting Width
 Cuts as low as 2.5"
 2 Blades
 Universal Skid-Steer Plate Attachment
 Hoses & Couplers Included (M450 Motor)
 Hoses Included, Couplers NOT Included (M550 & M650 Motor)
 4000 lb. Minimum Carrier Weight
 Built In Hydraulic System Protection
 1/4" Steel Deck Structure
 1342 lbs.

\$6,040.00 (M450 Motor)
\$6,400.00 (M550 Motor)
\$7,352.00 (M650 Motor)

CF372

Chain Curtain Protection on Front and Back
 82" Path Width
 72" Cutting Width
 Cuts as low as 2.5"
 2 Blades
 Universal Skid-Steer Plate Attachment
 Hoses & Couplers Included (M450 Motor)
 Hoses Included, Couplers NOT Included (M550 & M650 Motor)
 4,500 lb. Minimum Carrier Weight
 Built In Hydraulic System Protection
 1/4" Steel Deck Structure
 1390 lbs.

\$7,080.00 (M450 Motor)
\$7,440.00 (M550 Motor)
\$8,392.00 (M650 Motor)



SKIDSTEER MOUNT MODELS



CF560

Open Front with Push Bar
 Chain Curtain Protection on Back
 70" Path Width
 60" Cutting Width
 Cuts as low as 2.5"
 4 Blades
 Universal Skid-Steer Plate Attachment
 Hoses & Couplers Included (M450 Motor)
 Hoses Included, Couplers NOT Included (M550 & M650 Motor)
 4500 lb. Minimum Carrier Weight
 Built In Hydraulic System Protection
 1/4" Steel Deck Structure
 1540 lbs.

\$6,920.00 (M450 Motor)
\$7,280.00 (M550 Motor)
\$8,232.00 (M650 Motor)

CF572

Open Front with Push Bar
 Chain Curtain Protection on Back
 82" Path Width
 72" Cutting Width
 Cuts as low as 2.5"
 4 Blades
 Universal Skid-Steer Plate Attachment
 Hoses & Couplers Included (M450 Motor)
 Hoses Included, Couplers NOT Included (M550 & M650 Motors)
 5000 lb. Minimum Carrier Weight
 Built In Hydraulic System Protection
 1/4" Steel Deck Structure
 1570 lbs.

\$7,320.00 (M450 Motor)
\$7,680.00 (M550 Motor)
\$8,632.00 (M650 Motor)

BRUSH CUTTING SIZE CHART (Brush Diameter in Inches)

MOTOR	MOTOR TYPE	PSI	CASE DRAIN	12 GPM	15 GPM	18 GPM	20 GPM	22 GPM	25 GPM	30 GPM	40 GPM
Motor RPM				420	520	600	650	700			
M450	Roller-Vane	2500 3000	Not Needed	0.75" 1"	1" 1.25"	1.25" 1.5"	1.5" 2"	2" 2.5"	Damage to motor will occur		
Motor RPM				280			480	540	600	760	
M550	Roller-Vane	2500 3000	Recommended	1" 1.25"	-- --	-- --	1.75" 2"	2" 2.25"	2.5" 2.75"	3" 3.25"	-- --
Motor RPM							260	300	370	480	615
M650	Roller-Vane	2500 3000	Recommended	-- --	-- --	-- --	1.75" 2"	2" 2.25"	2.5" 2.75"	2.75" 3"	3" 4"

Gearbox is a 1 to 1.46 increaser
 Triple diameter capacity for felling trees



CSC744

Double Chain Curtain Protection on Back
57" Path Width
44" Cutting Width
Cuts as low as 0.5"
Universal Skid-Steer Plate Attachment
5500 lb. Minimum Carrier Weight
Built In Hydraulic System Protection
1/4" T1 Steel Deck Structure
Hoses Included, Couplers NOT Included
2000 lbs.
20 Teeth
R7000 Ripper Teeth*

\$18,800 (HS430 Motor)
\$19,200 (HS450 Motor)
\$21,200 (HS490 Motor)

CSC760

Double Chain Curtain Protection on Back
72" Path Width
60" Cutting Width
Cuts as low as 0.5"
Universal Skid-Steer Plate Attachment
8000 lb. Minimum Carrier Weight
Built In Hydraulic System Protection
1/4" T1 Steel Deck Structure
Hoses Included, Couplers NOT Included
2850 lbs.
30 Teeth
R7000 Ripper Teeth*

\$26,800 (HS790 Motor)

FIXED TOOTH ROTOR DISC

The 700 Series models are Disk Mulchers with fixed teeth, the same style as our 700 series Brush Mulchers. Additional information is available on-line.



*See front of the catalog for teeth details and pricing

BRUSH CUTTING SIZE CHART (Brush Diameter in Inches)

MOTOR	MOTOR TYPE	PSI	CASE DRAIN	15 GPM	20 GPM	25 GPM	30 GPM	35 GPM	40 GPM	45 GPM	50 GPM
RPM				1087	1449	1800					
HS430	Piston	3000	Critical	2.25"	3"	3.5"	Exceeding max value will not damage motor but performance will decrease and rotor may become unstable				
		3500		2.75"	3.5"	3.75"					
		4000		3"	3.75"	4"					
RPM				1219	1340	1607					
HS450	Piston	3000	Critical	--	3.25"	3.75"	4.5"	Exceeding max value will not damage motor but performance will decrease and rotor may become unstable			
		3500		--	3.75"	4"	4.75"				
		4000		--	4"	4.25"	5"				
RPM				789	964	140	1262	1420			
HS490	Piston	3000	Critical	--	--	4"	4.75"	5.5"	6"	6.75"	
		3500		--	--	4.25"	5"	6"	6.5"	7"	
		4000		--	--	4.5"	5.25"	6.25"	6.75"	7.25"	
RPM				789	964	140	1262	1420	1577		
HS790	Piston	3000	Critical	--	--	4"	4.75"	5.5"	6"	6.75"	Too fast -
		3500		--	--	4.25"	5"	6"	6.5"	7"	Unsafe
		4000		--	--	4.5"	5.25"	6.25"	6.75"	7.25"	

Direct drive setup. Triple diameter capacity for felling trees

ROTARY BRUSH MOWERS

EXCAVATOR



PRODUCT FEATURES

- Two cuts per pass for each blade
- Bent axis piston motor
- Carburized alloy steel shafts, 2.95" diameter
- 3-way blade assembly provides 75-100 slashes per second
- Heavy duty top and bottom rotors secure the 3-way blade assembly
- Solid platform deck built with 1/4" AR400 steel(3/8" on CXC550)

Visit baumalight.com for additional product information and product videos.

EXCAVATOR MOUNT MODELS



CXC530

40" Path Width
 30" Cutting Width
 Cuts as low as 2.5"
 3 Blades
 80 Slashes per Second
 Bolt-on Attachment
 2 Ton Min Carrier Weight (Max 10 Ton)
 Hydraulic Relief Valve System Protection
 1/4" AR400 Steel Deck
 Hoses & Couplers NOT Included
 550 lbs.

CXC542

50" Path Width
 42" Cutting Width
 Cuts as low as 2.5"
 3 Blades
 80 Slashes per Second
 Bolt-on Attachment
 3 Ton Min Carrier Weight (Max 15 Ton)
 Hydraulic Relief Valve System Protection
 1/4" AR400 Steel Deck
 Hoses & Couplers NOT Included
 640 lbs.

CXC550

67" Path Width
 50" Cutting Width
 Cuts as low as 2.5"
 3 Blades
 90 Slashes per Second
 Bolt-on Attachment
 8 Ton Min Carrier Weight (Max 20 Ton)
 Hydraulic Relief Valve System Protection
 3/8" AR400 Steel Deck
 Hoses & Couplers NOT Included
 1380 lbs.

\$8,400 (HX508 motor)
\$8,720 (HX510 motor)
\$8,960 (HX530 motor)

\$10,960 (HX530 motor)
\$11,080 (HX550 motor)
\$11,920 (HX570 motor)

\$12,040 (HX550 motor)
\$12,880 (HX570 motor)
\$13,680 (HX590 motor)

BRUSH CUTTING SIZE CHART (Brush Diameter in Inches)

MOTOR	PSI	CASE DRAIN	6 GPM	12 GPM	15 GPM	20 GPM	25 GPM	30 GPM	35 GPM	40 GPM	45 GPM	50 GPM
RPM			827	1637	2046							
HX508	3000	Critical	0.5"	2"	2.25"	--	--	--	--	--	--	--
	3500		0.75"	2.5"	2.75"	--	--	--	--	--	--	--
	4000		1.25"	2.75"	3"	--	--	--	--	--	--	--
RPM				1190	1492	1990						
HX510	3000	Critical	--	2.25"	2.5"	2.75"	--	--	--	--	--	--
	3500		--	2.75"	3"	3.5"	--	--	--	--	--	--
	4000		--	3"	3.25"	3.75"	--	--	--	--	--	--
RPM					1075	1450	1800					
HX530	3000	Critical	--	--	2.75"	3"	3.5"	--	--	--	--	--
	3500		--	--	3.5"	3.75"	4"	--	--	--	--	--
	4000		--	--	3.75"	4"	4.25"	--	--	--	--	--
RPM						1072	1340	1600				
HX550	3000	Critical	--	--	--	3.5"	3.75"	4"	--	--	--	--
	3500		--	--	--	4"	4.25"	4.5"	--	--	--	--
	4000		--	--	--	4.25"	4.5"	4.75"	--	--	--	--
RPM							1019	1223	1427	1631		
HX570	3000	Critical	--	--	--	--	4"	4.5"	5"	5.5"	--	--
	3500		--	--	--	--	4.5"	5"	5.5"	6"	--	--
	4000		--	--	--	--	4.75"	5.5"	6"	7"	--	--
RPM								946	1100	1260	1420	1580
HX590	3000	Critical	--	--	--	--	--	5"	5.5"	6"	7"	8"
	3500		--	--	--	--	--	5.5"	6"	7"	8"	9"
	4000		--	--	--	--	--	6"	7"	8"	9"	10"

Triple diameter capacity for felling trees, a rotor speed of over 1,800 rpm is not recommended on 42" model or larger

BOOM MOWERS

SKIDSTEER



PRODUCT FEATURES

- Curved boom for extra clearance
- Boom folds up for travel
- Pressure gauge to see your work load
- AR400 steel plate used on booms
- Available with AUX in-cab controls
- Armoured and sleeved hose protection
- Zinc plated greaseable pins
- Heavy duty cylinders
- Anti-slip mat for easy access to cab

Visit baumalight.com for additional product information and product videos.

SKIDSTEER MODELS



SWA500 SERIES



SWF500 SERIES



SWA700 SERIES

SWA540

4,500 lbs. Minimum Carrier Weight
6 ft. Reach (when flat)
48" Head (38 flail clusters)
Single Arm Boom
F2000 Flail Teeth (F3000 Teeth Optional)

- \$10,800 (D510G motor)**
- \$10,960 (D530G motor)**
- \$11,520 (D510 motor)**
- \$11,920 (D530 motor)**

SWF560

6,000 lbs. Minimum Carrier Weight
10 ft Reach (when flat)
48" Head (38 flail clusters)
Boom & Stick
F2000 Flail Teeth (F3000 Teeth Optional)

- \$12,480 (D510G motor)**
- \$12,640 (D530G motor)**
- \$13,200 (D510 motor)**
- \$13,600 (D530 motor)**

SWA550

5,000 lbs. Minimum Carrier Weight
7.5 ft Reach (when flat)
60" Head (48 flail clusters)
Single Arm Boom
F2000 Flail Teeth (F3000 Teeth Optional)

- \$11,040 (D510G motor)**
- \$11,200 (D530G motor)**
- \$11,760 (D510 motor)**
- \$12,160 (D530 motor)**

SWF580

8,000 lbs. Minimum Carrier Weight
14 ft Reach (when flat)
48" Head (38 flail clusters)
Boom & Stick
F2000 Flail Teeth (F3000 Teeth Optional)

- \$14,040 (D510G motor)**
- \$14,200 (D530G motor)**
- \$14,760 (D510 motor)**
- \$15,160 (D530 motor)**

SWA560

5,500 lbs. Minimum Carrier Weight
10 ft Reach (when flat)
60" Head (48 flail clusters)
Single Arm Boom
F2000 Flail Teeth (F3000 Teeth Optional)

- \$11,520 (D510G motor)**
- \$11,680 (D530G motor)**
- \$12,240 (D510 motor)**
- \$12,640 (D530 motor)**

SWA750

8,000 lbs. Minimum Carrier Weight
7 ft Reach (when flat)
42" Head (3 blades)
Single Arm Boom
Rotary Cutter Blades (CXC542)

- \$16,400 (HX550 motor)**
- \$16,680 (HX570 motor)**

All prices are without controls - see control options below.
Hoses included, couplers not included.
Custom configurations may be available upon request.

MOTOR OPTIONS Running a skidsteer at half throttle is ideal.

MOTOR	MOTOR TYPE	CC	CASE DRAIN	IDEAL RPM	20 GPM	25 GPM	30 GPM	35 GPM	40 GPM
D510G*	Gear	33							
D510*	Piston	34	Critical	2200	1500 RPM	2000 RPM	2500 RPM	2900 RPM	3400 RPM
D530G*	Gear	46							
D530*	Piston	47	Critical	2100	1000 RPM	1500 RPM	1800 RPM	2100 RPM	2500 RPM
HX550**	Piston	64	Critical	1400	800 RPM	1100 RPM	1350 RPM	1600 RPM	1875 RPM
HX570**	Piston	84	Critical	1200	600 RPM	850 RPM	1000 RPM	1200 RPM	1450 RPM

* 500 Series brush cutting size charts are available online at baumalight.com
** 700 Series brush cutting size charts are available in the Rotary Brush Mower section of this catalog

CONTROLLER OPTIONS Must be priced separately.

SERIES	PART #	REQUIRED LIVE AUX PINS ON BOOM	CONTROLLER DESCRIPTION	PRICE
SWA	D004904 **	4 live	Best option - use buttons built right into joy sticks in skidsteer	\$1,120
	D004905 **	3 live	Second Best option - use joystick buttons - required to hold two for some functions	\$1,200
	D004906	Plug into 12V in cab	Plug into D004904 and have a control box on your lap - D004904 also needed	\$360.00
	D004907 ~	Plug into 12V in cab	Plug into D004905 and have a control box on your lap - D004905 also needed	\$384.00
SWF	D004908 **	6 live	Best option - use buttons built right into joy sticks in skidsteer	\$1,480
	D004909 **	4 live	Second Best option - use joystick buttons - required to hold two for some functions	\$1,640
	D004910	Plug into 12V in cab	Plug into D004908 and have a control box on your lap - D004908 also needed	\$400.00
	D004911 ~	Plug into 12V in cab	Plug into D004909 and have a control box on your lap - D004909 also needed	\$480.00

**Add \$500 if field installed
~Operation for this option will be difficult

BRUSH MULCHERS

TRACTOR



PRODUCT FEATURES

- Integrated push bar bends taller brush
- Spiral tooth pattern for smoother mulching
- Powder coated heavy duty frame
- Heavy duty gearbox for high performance
- Reinforced belt delivers force from the gear box to the rotor
- Hydraulic door opens and closes to control mulching action (500 and 700 Series)

Visit baumalight.com for additional product information and product videos.

TRACTOR MOUNT MODELS



MP572

- 87" Path Width
- 72" Rotor Width
- 50 HP Engine Minimum (125 HP Maximum)
- 115 HP PTO Maximum
- 1.5" Above to 1" Below Grade Cutting Depth
- 2" Rotor Shaft
- 15" Rotor Diameter (tool tips)
- 700 lb. Rotor (with tools)
- CAT 2 3PH
- Quick Hitch Compatible: No
- 1000 RMP Drive Speed
- Optional 540 RPM Drive Speed (Max 110 HP)
- 1 3/8" Gearbox Spline Size
- 1 3/8" Tractor End Spline Size
- Slip Clutch Protection
- 2500 lb.
- 160 Teeth
- 2 hydraulic remotes required
- P5000 Planer Teeth* (Standard)
- R5000 Ripper Teeth* (Optional)

\$23,600

\$25,100

- Optional 540RPM Gearbox
- Not to exceed 110HP

*See front of the catalog for teeth details and pricing



iMP772

- 84" Path Width
- 72" Rotor Width
- 90 HP Engine Minimum (135 HP Maximum)
- 125 HP PTO Maximum
- Level to 4" Below Cutting Depth
- Front and rear doors hydraulically controlled from the cab
- 2" Rotor Shaft
- 17.25" Rotor Diameter (tool tips)
- 930 lb. Rotor (with tools)
- CAT 2 or 3 3PH
- Quick Hitch Compatible: No
- 1000 RMP Drive Speed
- 1 3/8" Gearbox Spline Size
- 1 3/8" Tractor End Spline Size
- Slip Clutch Protection
- 4558 lb.
- 94 Teeth
- 2 hydraulic remotes required
- R7000 Ripper Teeth* (Standard)
- P7000 Planer Teeth* (Can be switched out by customer only)

\$33,600

\$35,100

Max 110 Hp (1,000 rpm)

Optional 540)RPM

\$1,480

- Optional larger PTO shaft to increase HP
- Not to exceed 165 engine HP (1,000 rpm)
- 1.75" Tractor End Spline (20-spline)

BRUSH CUTTING SIZE CHART (Brush Diameter in Inches)

MODEL	TRACTOR SPEED	RPM	65 HP	75 HP	100 HP	125 HP	150 HP
MP572	Low Gear		2.5"	3"	3.5"	4"	--
	Creep	1800	4"	5"	6"	7"	--
	Hydrostatic		6"	8"	10"	12"	--
iMP772	Low Gear		--	--	5"	7"	8"
	Creep	1800	--	--	7"	8"	10"
	Hydrostatic		--	--	11"	13"	15"

Double brush size for "stop and chew" cutting.

NOTICE: HP value must never be exceeded or slip clutch will burn, warranty is void

TRACTOR MOUNT MODELS



MP348

60" Path Width
 48" Rotor Width
 25 HP Engine Minimum (50 HP Maximum)
 40 HP PTO Maximum
 Level Cutting Depth
 2" Rotor Shaft
 15" Rotor Diameter (tool tips)
 230 lb. Rotor (with tools)
 CAT 1 3PH
 Quick Hitch Compatible: No
 540 RMP Drive Speed
 1 3/8" Gearbox Spline Size
 1 3/8" Tractor End Spline Size
 Slip Clutch Protection
 1050 lb.
 H3000 Speed Teeth*
 60 Teeth

\$10,080

MP360

72" Path Width
 60" Rotor Width
 30 HP Engine Minimum (55 HP Maximum)
 45 HP PTO Maximum
 Level Cutting Depth
 2" Rotor Shaft
 15" Rotor Diameter (tool tips)
 315 lb. Rotor (with tools)
 CAT 1 3PH
 Quick Hitch Compatible: No
 540 RMP Drive Speed
 1 3/8" Gearbox Spline Size
 1 3/8" Tractor End Spline Size
 Slip Clutch Protection
 1200 lb.
 H3000 Speed Teeth*
 74 Teeth

\$11,400

*See front of the catalog for teeth details and pricing

BRUSH CUTTING SIZE CHART (Brush Diameter in Inches)

MODEL	TRACTOR SPEED	RPM	25 HP	30 HP	40 HP	55 HP
300 Series	Low Gear Slow Reverse	1800	0.5"	1"	1.5"	2"
	Low Gear Stop & Chew		1"	1.5"	2"	2.5"
	Hydrostatic Slow Reverse		1.5"	2"	2.5"	3"
	Hydrostatic Stop & Chew		2"	3"	4"	5"

Double brush size for "stop and chew" cutting.

NOTICE: This value must never be exceeded or slip clutch will burn, warranty is void



MP548

- 62" Path Width
- 48" Rotor Width
- 40 HP Engine Minimum (75 HP Maximum)
- 65 HP PTO Maximum
- Level Cutting Depth
- 2" Rotor Shaft
- 15" Rotor Diameter (tool tips)
- 480 lb. Rotor (with tools)
- CAT 2 3PH
- Quick Hitch Compatible: No
- 540 RMP Drive Speed
- 1 3/8" Gearbox Spline Size
- 1 3/8" Tractor End Spline Size
- Slip Clutch Protection
- 1600 lb.
- 104 Teeth
- P5000 Planer Teeth* (Standard)
- R5000 Ripper Teeth* (Optional)

Quote

*See front of the catalog for teeth details and pricing

MP560

- 75" Path Width
- 60" Rotor Width
- 45 HP Engine Minimum (75 HP Maximum)
- 65 HP PTO Maximum
- 1.5" Above to 1" Below Grade Cutting Depth
- Back door hydraulically controlled from the cab gives control of the mulching action
- 2" Rotor Shaft
- 15" Rotor Diameter (tool tips)
- 575 lb. Rotor (with tools)
- CAT 2 3PH
- Quick Hitch Compatible: No
- 540 RMP Drive Speed
- 1 3/8" Gearbox Spline Size
- 1 3/8" Tractor End Spline Size
- Slip Clutch Protection
- 2145 lb.
- 126 Teeth
- 1 hydraulic remote required
- P5000 Planer Teeth* (Standard)
- R5000 Ripper Teeth* (Optional)

\$16,440

BRUSH CUTTING SIZE CHART (Brush Diameter in Inches)

MODEL	TRACTOR SPEED	RPM	45 HP	50 HP	60 HP	68 HP
MP548/ MP560	Low Gear	1800	1"	1.5"	2"	2.5"
	Creeper		2"	2.5"	3"	4"
	Hydrostatic		3"	4"	5"	6"

Double brush size for "stop and chew" cutting.

NOTICE: HP value must never be exceeded or slip clutch will burn, warranty is void

BRUSH MULCHERS

SKIDSTEER



PRODUCT FEATURES

- Integrated push bar bends taller brush
- Spiral tooth pattern for smoother mulching
- Powder coated heavy duty frame
- Armoured and sleeved hose protection
- V-Notch hardened tooth holders resist bending (500 Series)
- Over-torque protection relief valve protects motor
- Reinforced belt delivers force from the gearbox to rotor

Visit baumalight.com for additional product information and product videos.

SKIDSTEER MOUNT MODELS



MS248

- 60" Path Width
- 48" Rotor Width
- 2000lb min carrier weight
- Level Cutting Depth
- Swing Holder Style
- 17.25" Rotor Diameter (tool tips)
- 125 lb. Rotor (with tools)
- Built-In Relief System Protection
- Hydraulic Couplers Included
- 750 lb. Unit Shipping Weight
- 30 Teeth
- F2000 Flail Teeth* (Standard)
- F3000 Flail Teeth* (Optional)

\$4,792 MS248 IS FOR LARGE SKIDSTEER PLATE
FMM148 IS FOR MINI SKIDSTEER PLATE

See back of Brush Mulcher section for motor specific brush size charts.
*See front of the catalog for teeth details and pricing

MS348

- 60" Path Width
- 48" Rotor Width
- 3000lb min carrier weight
- Level Cutting Depth
- Fixed Holder Style
- 15" Rotor Diameter (tool tips)
- 230 lb. Rotor (with tools)
- Built-In Relief System Protection
- Hydraulic Couplers Included
- 950 lb. Unit Shipping Weight
- 60 Teeth
- H3000* Speed Teeth

\$8,636

SKIDSTEER MOUNT MODELS



MS548

62" Path Width
 48" Rotor Width
 4000lb min carrier weight
 1.5" Above to 1" Below Grade Cutting Depth
 Fixed Holder Style
 15" Rotor Diameter (tool tips)
 480 lb Rotor (with tools)
 Built-In Relief System Protection
 Large PSI pressure gauge for maintaining optimal flow
 Check with Dealer for Couplers
 1491 lb.
 104 Teeth
 P5000 Planer Teeth* (Standard)
 R5000 Ripper Teeth* (Optional)

\$13,280 (A450 Motor)
\$13,520 (B550 Motor)
\$16,200 (C508 Motor)
\$16,360 (C510 Motor)
\$17,200 (C530 Motor)
\$17,400 (C540 Motor)

See back of Brush Mulcher section for MOTOR OPTIONS - BRUSH SIZE CHART
 *See front of the catalog for teeth details and pricing



MS560

75" Path Width
 60" Rotor Width
 5500lb min carrier weight
 1.5" Above to 1" Below Grade Cutting Depth
 Fixed Holder Style
 15" Rotor Diameter (tool tips)
 575 lb. Rotor (with tools)
 Built-In Relief Protection
 Large PSI pressure gauge for maintaining optimal flow
 Check with Dealer for Couplers
 2115 lb.
 126 Teeth
 P5000 Planer Teeth* (Standard)
 R5000 Ripper Teeth* (Optional)

\$18,520 (C508 Motor)
\$18,680 (C510 Motor)
\$19,520 (C530 Motor)
\$19,720 (C540 Motor)
\$19,840 (C550 Motor)

MS572

87" Path Width
 72" Rotor Width
 6000lb min carrier weight
 1.5" Above to 1" Below Grade Cutting Depth
 Fixed Holder Style
 15" Rotor Diameter (tool tips)
 700 lb. Rotor (with tools)
 Built-In Relief Protection
 Large PSI pressure gauge for maintaining optimal flow
 Check with Dealer for Couplers
 2266 lb.
 160 Teeth
 P5000 Planer Teeth (Standard) **\$21,280 (C530 Motor)**
 R5000 Ripper Teeth (Optional) **\$21,480 (C540 Motor)**
\$21,600 (C550 Motor)





MS960

75" Path Width
60" Rotor Width
7,000lb min carrier weight
Level standard - optional skid shoes for below ground
Fixed Holder Style
18.5" Rotor Diameter (tool tips)
860 lb. Rotor (with tools)
Built-In Relief Protection
Large PSI pressure gauge for maintaining optimal flow
Couplers NOT Included
2,724 lb.
38 Teeth
R9000 Ripper Teeth (Standard)
P9000 Planer Teeth (Can be switched out by customer only)

\$25,680 (C930 Motor)
\$25,880 (C940 Motor)
\$26,000 (C950 Motor)
\$26,400 (C970 Motor)

See back of Brush Mulcher section for MOTOR OPTIONS - BRUSH SIZE CHART
*See front of the catalog for teeth details and pricing

MS972

84" Path Width
72" Rotor Width
7,500lb min carrier weight
Level standard - optional skid shoes for below ground
Fixed Holder Style
18.5" Rotor Diameter (tool tips)
1,105 lb. Rotor (with tools)
Built-In Relief Protection
Large PSI pressure gauge for maintaining optimal flow
Couplers NOT Included
3115 lb.
43 Teeth
R9000 Ripper Teeth (Standard)
P9000 Planer Teeth (Can be switched out by customer only)

\$27,360 (C930 Motor)
\$27,560 (C940 Motor)
\$27,680 (C950 Motor)
\$28,080 (C970 Motor)



MS1160

75" Path Width
60" Rotor Width
7,000lb min carrier weight
Level standard - optional skid shoes
Fixed Holder Style
19.3" Rotor Diameter (tool tips)
860 lb. Rotor (with tools)
Built-In Relief Protection
Large PSI pressure gauge for maintaining optimal flow
Couplers NOT Included
2,800 lb.
31 Teeth
R11000 Sharpenable Planer Teeth

\$30,240 (C1130 Motor)
\$30,440 (C1140 Motor)
\$30,560 (C1150 Motor)
\$30,960 (C1170 Motor)

BRUSH MULCHERS EXCAVATOR



PRODUCT FEATURES

- Spiral tooth pattern for smoother mulching
- Powder coated heavy duty frame
- V-North hardened tooth holders resist bending
- Over-torque protection relief valve protects motor
- Reinforced belt delivers force from the gearbox to rotor
- Overhung load adapter with tapered roller bearings
- Wire fencing protection kit
- Integrated skid shoes to float along ground

Visit baumalight.com for additional product information and product videos.

EXCAVATOR MOUNT MODELS



MX230

- 38" Path Width
- 30" Rotor Width
- 6 Ton Maximum Carrier Weight
- 2 Ton Minimum Carrier Weight
- Level Cutting Depth
- Swing Holder Style
- 1.5" Rotor Shaft
- 17.25" Rotor Diameter (tool tips)
- 125 lb. Rotor (with tools)
- Built-In Relief System Protection
- 500 lb.
- 22 Teeth
- F2000 Flail Teeth* (Standard)
- F3000 Flail Teeth* (Optional)

\$4,784

See back of Brush Mulcher section for MOTOR OPTIONS - BRUSH SIZE CHART
*See front of the catalog for teeth details and pricing



MX330

- 38" Path Width
- 30" Rotor Width
- 8 Ton Maximum Carrier Weight
- 3 Ton Minimum Carrier Weight
- Level Cutting Depth
- Fixed Holder Style
- 2" Rotor Shaft
- 15" Rotor Diameter (tool tips)
- 175 lb. Rotor (with tools)
- Built-In Relief System Protection
- 750 lb.
- 36 Teeth
- H3000* Speed Teeth

\$7,344



MX530

- 40" Path Width
- 30" Rotor Width
- 12 Ton Maximum Carrier Weight
- 4 Ton Minimum Carrier Weight
- Level Cutting Depth
- Fixed Holder Style
- 2" Rotor Shaft
- 15" Rotor Diameter (tool tips) **\$10,640 (A450 Motor)**
- 300 lb. Rotor (with tools) **\$10,880 (B550 Motor)**
- Built-In Relief System Protection **\$13,560 (C508 Motor)**
- 1036 lb. **\$13,720 (C510 Motor)**
- 64 Teeth **\$14,560 (C530 Motor)**
- Carbit Tipped Bolt In Cutting Style **\$14,760 (C540 Motor)**
- \$14,880 (C550 Motor)**

EXCAVATOR MOUNT MODELS



MX548

62" Path Width
 48" Rotor Width
 20 Ton Maximum Carrier Weight
 8 Ton Minimum Carrier Weight
 Level Cutting Depth
 Fixed Holder Style
 2" Rotor Shaft
 15" Rotor Diameter (tool tips)
 408 lb. Rotor (with tools)
 Built-In Relief System Protection
 Hoses & Couplers NOT Included
 2167 lb.
 104 Teeth
 P5000 Planer Teeth* (Standard)
 R5000 Ripper Teeth* (Optional)

\$16,440 (C508 Motor)
\$16,600 (C510 Motor)
\$17,440 (C530 Motor)
\$17,640 (C540 Motor)
\$17,760 (C550 Motor)
\$18,160 (C570 Motor)
\$18,960 (C590 Motor)

See back of Brush Mulcher section for MOTOR OPTIONS - BRUSH SIZE CHART

*See front of the catalog for teeth details and pricing



MX548R with Root Rake

62" Path Width
 48" Rotor Width
 20 Ton Maximum Carrier Weight
 8 Ton Minimum Carrier Weight
 Level Cutting Depth
 Fixed Holder Style
 2" Rotor Shaft
 15" Rotor Diameter (tool tips)
 408 lb. Rotor (with tools)
 Built-In Relief System Protection
 Hoses & Couplers NOT Included
 2167 lb.
 104 Teeth
 P5000 Planer Teeth* (Standard)
 R5000 Ripper Teeth* (Optional)

\$16,920 (C508 Motor)
\$17,080 (C510 Motor)
\$17,920 (C530 Motor)
\$18,120 (C540 Motor)
\$18,240 (C550 Motor)
\$18,640 (C570 Motor)
\$19,440 (C590 Motor)

iMX748

65" Path Width
 48" Rotor Width
 25 Ton Maximum Carrier Weight
 18 Ton Minimum Carrier Weight
 Level Cutting Depth
 Fixed Holder Style
 2" Rotor Shaft
 17.25" Rotor Diameter (tool tips)
 670 lb. Rotor (with tools)
 Built-In Relief System Protection
 Hoses & Couplers NOT Included
 3180 lb.
 62 Teeth
 R7000 Ripper Teeth (Standard)
 P7000 Planer Teeth (Can be switched out by customer only)

\$23,560 (C740 Motor)
\$23,680 (C750 Motor)
\$24,080 (C770 Motor)
\$24,880 (C790 Motor)





iMX748R with Root Rake

- 70" Path Width
- 48" Rotor Width
- 33 Ton Maximum Carrier Weight
- 20 Ton Minimum Carrier Weight
- Level Cutting Depth
- Fixed Holder Style
- 2" Rotor Shaft
- 17.25" Rotor Diameter (tool tips)
- 670 lb. Rotor (with tools)
- Built-In Relief System Protection
- Hoses & Couplers NOT Included
- 3300 lb.
- 62 Teeth
- R7000 Ripper Teeth* (Standard)
- P7000 Planer Teeth* (Can be switched out by customer only)

- \$25,720 (C740 Motor)**
- \$25,840 (C750 Motor)**
- \$26,240 (C770 Motor)**
- \$27,040 (C790 Motor)**

See back of Brush Mulcher section for MOTOR OPTIONS - BRUSH SIZE CHART
*See front of the catalog for teeth details and pricing



MX960R

- 90" Path Width
- 60" Rotor Width
- 33 Ton Maximum Carrier Weight
- 18 Ton Minimum Carrier Weight
- Level Cutting Depth
- Fixed Holder Style
- 2" Rotor Shaft
- 18.5" Rotor Diameter (tool tips)
- 860 lb. Rotor (with tools)
- Built-In Relief System Protection
- Hoses & Couplers NOT Included
- 2910 lb.
- 38 Teeth
- R9000 Ripper Teeth* (Standard)
- T9000 Planer Teeth* (Can be switched out by customer only)

- \$29,480 (C940 Motor)**
- \$29,600 (C950 Motor)**
- \$30,000 (C970 Motor)**
- \$30,800 (C990 Motor)**



MX1160R

- 90" Path Width
- 60" Rotor Width
- 33 Ton Maximum Carrier Weight
- 18 Ton Minimum Carrier Weight
- Level Cutting Depth
- Fixed Holder Style
- 2" Rotor Shaft
- 18.5" Rotor Diameter (tool tips)
- 870 lb. Rotor (with tools)
- Built-In Relief System Protection
- Hoses & Couplers NOT Included
- 2925 lb.
- 31 Teeth
- P11000 Ripper Teeth* (Standard)
- T9000 Planer Teeth* (Can be switched out by customer only)

- \$33,480 (C1140 Motor)**
- \$33,600 (C1150 Motor)**
- \$34,000 (C1170 Motor)**
- \$34,800 (C1190 Motor)**

SKIDSTEER & EXCAVATOR BRUSH CUTTING SIZE CHARTS

(Brush Diameter in Inches)

MOTOR	PSI	CASE DRAIN	12 GPM	15 GPM	18 GPM	20 GPM
RPM			832	1060	1250	1390
200 Series Motor Standard Cup Teeth	2500	Not	0.25"	0.375"	0.5"	0.75"
	3000	Important for Roller-Vane motors	0.375"	0.5"	0.75"	1"
	3500		0.375"	0.5"	0.75"	1"
RPM			832	1060	1250	1390
200 Series Motor Heavy Blade Teeth	2500	Not	0.5"	0.75"	1"	1.5"
	3000	Important for Roller-Vane motors	0.75"	1"	1.5"	2"
	3500		0.75"	1"	1.5"	2"
RPM			832	1060	1250	1390
300 Series Motor	2500	Not	0.75"	1"	1.25"	2"
	3000	Important for Roller-Vane motors	1"	1.25"	1.5"	2.5"
	3500		1"	1.25"	1.5"	2.5"

(Brush Diameter in Inches)

MOTOR	PSI	CASE DRAIN	8 GPM	12 GPM	15 GPM	20 GPM	25 GPM	30 GPM	35 GPM	40 GPM	45 GPM
RPM			555	832	1060	1390					
A450 Roller-Vane	2500	Not Needed	0.25"	0.75"	1"	1.5"	--	--	--	--	--
	3000	Not Needed	0.5"	1"	1.25"	2"	--	--	--	--	--
	3500	Recommended	0.5"	1"	1.25"	2"	--	--	--	--	--
RPM			640	846	1100	1370	1600				
B550 Roller-Vane	2500	Not Needed	--	0.25"	0.75"	1.25"	2.5"	3"	--	--	--
	3000	Recommended	--	0.5"	1"	1.75"	3"	3.5"	--	--	--
	3500	Needed	--	0.5"	1"	1.75"	3"	3.5"	--	--	--
RPM			1090	1640	2050						
C508 Bent Axis Piston	3000		1.5"	2.25"	2.75"	--	--	--	--	--	--
	3500	Critical	2"	2.75"	3.25"	--	--	--	--	--	--
	4000		2.5"	3.25"	4"	--	--	--	--	--	--
RPM			1190	1490	2000	2490					
C510 Bent Axis Piston	3000		--	2"	2.5"	3"	3.5"	--	--	--	--
	3500	Critical	--	2.5"	3"	3.5"	4.5"	--	--	--	--
	4000		--	3"	3.5"	4.5"	5"	--	--	--	--
RPM					1450	1800	2100				
C530 Bent Axis Piston	3000		--	--	--	3"	4"	5"	--	--	--
	3500	Critical	--	--	--	3.5"	4.5"	5.5"	--	--	--
	4000		--	--	--	4.5"	5"	5.75"	--	--	--
RPM						1500	1800	2100			
C540 Bent Axis Piston	3000		--	--	--	--	3.75"	5.5"	6"	--	--
	3500	Critical	--	--	--	--	4.25"	5.75"	6.5"	--	--
	4000		--	--	--	--	4.75"	6"	7"	--	--
RPM							1600	1875	2140		
C550 Bent Axis Piston	3000		--	--	--	--	--	5"	6.5"	7"	--
	3500	Critical	--	--	--	--	--	5.5"	7"	7.5"	--
	4000		--	--	--	--	--	5.75"	7.5"	8"	--

Double brush size for "stop and chew" cutting for skidsteer models ONLY

NOTICE: Max GPM value must NEVER be exceeded on roller-vane motors or failure will occur, Piston motors run much faster before failure will occur

NOTICE: Above GPM values are under load flow estimates



(Brush Diameter in Inches)

MOTOR	PSI	CASE DRAIN	20 GPM	25 GPM	30 GPM	35 GPM	40 GPM	45 GPM	50 GPM	55 GPM	60 GPM
RPM						1400	1630	1830	2030		
C570 Bent Axis Piston	3000		--	--	--	6"	5.5"	7"	7.5"	--	--
	3500	Critical	--	--	--	6.5"	6"	7.5"	8"	--	--
	4000		--	--	--	7"	6.5"	8"	8.5"	--	--
RPM			1450	1800	2100						
C930 Bent Axis Piston	3000		4"	5"	6"	--	--	--	--	--	--
	3500	Critical	4.5"	5.5"	6.5"	--	--	--	--	--	--
	4000		5.5"	6"	7"	--	--	--	--	--	--
RPM				1500	1800	2100					
C940 Bent Axis Piston	3000		--	4.75"	6.5"	7"	--	--	--	--	--
	3500	Critical	--	5.25	6.75"	7.5"	--	--	--	--	--
	4000		--	5.75"	7"	8"	--	--	--	--	--
RPM					1600	1875	2140				
C950 Bent Axis Piston	3000		--	--	6"	7.5"	8"	--	--	--	--
	3500	Critical	--	--	6.5"	8"	8.5"	--	--	--	--
	4000		--	--	6.75	8.5"	9"	--	--	--	--
RPM						1400	1630	1830	2030		
C970 Bent Axis Piston	3000		--	--	--	6"	6.5"	8"	8.5"	--	--
	3500	Critical	--	--	--	7.5"	7"	8.5"	9"	--	--
	4000		--	--	--	8"	7.5"	9"	9.5"	--	--
RPM								1400	1570	1750	1900
C990 Bent Axis Piston	3000		--	--	--	--	--	6"	8.5"	10"	10.5"
	3500	Critical	--	--	--	--	--	6.5"	9"	10.5"	11"
	4000		--	--	--	--	--	7"	10"	11"	12"
RPM			1450	1800	2100						
C1130 Bent Axis Piston	3000		5"	6"	7"	--	--	--	--	--	--
	3500	Critical	5.5"	6.5"	7.5"	--	--	--	--	--	--
	4000		6.5"	7"	8"	--	--	--	--	--	--
RPM				1500	1800	2100					
C1140 Bent Axis Piston	3000		--	6.75"	8.5"	9"	--	--	--	--	--
	3500	Critical	--	7.25"	8.75"	9.5"	--	--	--	--	--
	4000		--	7.75"	9"	10"	--	--	--	--	--
RPM					1600	1875	2140				
C1150 Bent Axis Piston	3000		--	--	9"	10.5"	11"	--	--	--	--
	3500	Critical	--	--	9.5"	11"	11.5"	--	--	--	--
	4000		--	--	9.75"	11.5"	12"	--	--	--	--
RPM						1400	1630	1830	2030		
C1170 Bent Axis Piston	3000		--	--	--	10"	10.5"	12"	12.5"	--	--
	3500	Critical	--	--	--	11.5"	11"	12.5"	13"	--	--
	4000		--	--	--	12"	11.5"	13"	13.5"	--	--
RPM								1400	1570	1750	1900
C1190 Bent Axis Piston	3000		--	--	--	--	--	10.5"	13"	14.5"	15"
	3500	Critical	--	--	--	--	--	11"	13.5"	15"	15.5"
	4000		--	--	--	--	--	11.5"	14.5"	15.5"	16.5"

Double brush size for "stop and chew" cutting for skidsteer models ONLY

NOTICE: Same motor is used for 500, 700, 900 & 1100 series mulchers, the larger rotors in the bigger series can mulch more with the same motor

NOTICE: Above GPM values are under load flow estimates

TILE DRAINAGE PLOW

TRACTOR



PRODUCT FEATURES

- Strong wear resistant AR400 shank
- Adjustable mast
- Durable powder coat finish
- Up to 5' trenching depth
- Hardened steel bushings
- Danfoss valve

Visit baumalight.com for additional product information and product videos.

TRACTOR MODELS



UPP748

48" Max Depth

4" tile size
15,000-25,000 lbs. recommended tractor weight
(30,000 lbs. Max)
Minimum tractor weight depends on soil
CAT 3 Hitch size
Quick Hitch Compatible: No
*2 remotes required
Shank made with AR400 steel
2,350 lbs. weight
3,000 lbs. shipping weight

\$23,160
\$760 (shipping skid)

8 WEEKS SAVES 8%
\$21,307
\$699 (shipping skid)

*Add 1 extra remote for power tile feeder

UPP760

60" Max Depth

4" & 6" tile size
20,000-40,000 lbs. recommended tractor weight
(45,000 lbs. Max)
Minimum tractor weight depends on soil
CAT 4 Hitch size
Quick Hitch Compatible: No
*2 remotes required
Shank made with 2" AR400 solid steel
4,650 lbs. weight
5,600 lbs. shipping weight

\$29,000
\$1,596 (tile feeder)
\$1,400 (shipping skid)

8 WEEKS SAVES 8%
\$26,680
\$1,468 (tile feeder)
\$1,288 (shipping skid)



Optional Tile Feeder

As of January 1, 2021, trailers, plows and accessories are no longer offered with free freight.

Available promotions

8 WEEKS SAVES 8%

Plan ahead and save

To reward and encourage you to plan ahead Baumalight is offering an 8% discount on pre-ordered drainage plows. This program allows you to order a plow at an 8% discount for delivery in 8 weeks. This program allows us to reward the prepared and also keep stock for the times when customers have immediate needs.

FREE IN-FIELD TRAINING OR \$1000 CREDIT

When you order a Baumalight drainage plow, receive an in-field training session or a \$1000 list price purchase credit. Training session to be provided by dealer or territory manager.

TILE DRAINAGE PLOW TRAILER



PRODUCT FEATURES

- Strong 2" AR400 shank
- Adjustable mast
- Durable powder coat finish
- 5' trenching depth
- Hardened steel bushings
- Danfoss valve

Visit baumalight.com for additional product information and product videos.

**8 WEEKS
SAVES 8%**

**FREE IN-FIELD
TRAINING
OR \$1000 CREDIT**



TRAILER MODELS

UPT760

60" Max Depth

4" & 6" tile size

25,000-45,000 lbs. recommended tractor weight
(50,000 lbs. Max)

Minimum tractor weight depends on soil

Draw bar hitch size

*2 remotes required

Shank made with AR400 steel

\$33,600

**8 WEEKS
SAVES 8%**
\$30,912

*Add 1 extra remote for power tile feeder

*Must be loaded on a low deck truck or towed

As of January 1, 2021, trailers, plows and accessories are no longer offered with free freight.

PRODUCT FEATURES

- Hydraulic hoist
- Fold in wing to load
- Hardened steel bushings

Visit baumalight.com for additional product information and product videos.



TILE CART



UST510

- Single axle
- Tractor draw bar hitch
- One remote required
- Two remotes if ordered with power table turner

\$7,880

\$920 (shipping skid)

8 WEEKS SAVES 8%

\$7,250

\$846 (shipping skid)

As of January 1, 2021, trailers, plows and accessories are no longer offered with free freight.

ACCESSORIES



Laser Guidance System

Controlling bought from Latec Rugged, reliable and accurate, the Latec LT-180 is an affordable, automatic true self-leveling single slope laser. Ideal for drainage work, the Latec LT-180 is the perfect partner for your Undertow to ensure exceptional leveling when plowing.

\$Included in main price



Heavy Duty Tripod

The Undertow's heavy duty tripod features fiberglass construction with extendable legs and an adjustment range of 3' 8" to 6'.

\$680 (D003681)



Tile Feeder

Available on the UPP760 and UPT760, the optional tile feeder is designed to assist tile movement while limiting stretch in the tile, thereby improving overall drainage performance.

\$1,596 (D003644)



BAUMALIGHT.COM/AUX

AUXILIARY ELECTRICAL CONNECTORS

Connecting equipment can be confusing, difficult and time consuming especially when the attachment has more than one Hydraulic function.

All you want to do, is get down to work.

Baumlight now offers a more direct and simple way of connecting.

The Baumlight Auxiliary Electrical Connection. We can now connect to your skidsteer's auxiliary electrical connection.

So connection is as easy as connecting the hydraulics and plugging in the electrical.

Now you can control the attachment with the controls in your cab.





Getting ready for quick hook-ups and less cab clutter is easy. Let us know the make and model of your skidsteer and we will configure it so it is ready to go.

Single Skidsteers

Getting set up is extremely easy. Once you have picked your attachment, let your dealer know you want the Baumalight Aux Electrical Connection, then let us know the make and model of your skidsteer and we'll configure the connection for your individual skidsteer - for immediate plug and play operation.



Multiple Skidsteers

If you have multiple skidsteers of different makes and models, they may need different pin configurations.



We have adapter plugs to solve the problem. Let us know at the time of ordering that you want one or more adapters along with the make and model they are for and we will configure them for you. Baumalight adapter plugs will let you enjoy the convenience of operating multiple attachments with multiple skidsteers.

Pin Tool

Every Baumalight Aux Electrical Connection ships with a blue pin tool. With this tool you can re-configure the Aux connection to another skidsteer pin configuration. This allows you to change your connection to match a new skidsteer model



Retro Fit Attachments

We can also retro fit your existing Baumalight attachments to work with the Aux Electrical Connection. Pricing varies depending on age and current set up, so call for details and we will walk you through the process.



Older Skid Steers

Is one of your skidsteers older, without an auxiliary electrical connection?



We also have an in-cab adapter to plug into your Aux Electrical Connected attachments that will allow you to run them. Plug the adapter into the attachment, connect it to 12V and now you can run your new attachment on an older skidsteer.

EXCAVATOR

MOUNTING



OPTION 1: BLANK WELD ON PLATE

This blank plate is designed ready for you to weld on ear lugs for your specific Excavator application then bolted on to the attachment.

PART #	DESCRIPTION	WEIGHT (Lbs.)	PRICE
D001161	Blank Weld-on Plate - Excavator up to 10 Ton	48	\$96
D004951	Set of 10 5/8" x 2" G5 bolts w/ lock nuts - Free if mount ordered w/ whole good		\$56
D001419	Blank Weld-on Plate - Excavator over 8 Ton	90	\$160
D004952	Set of 26 5/8" x 2" G5 bolts w/ lock nuts - Free if mount ordered w/ whole good		\$146



D001161

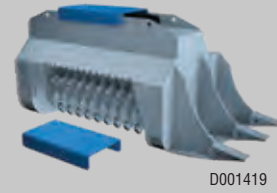

D001419

OPTION 2: SEE LEADTIME ONLINE! TURN-KEY MOUNTING. PIN ON OR QUICK COUPLER

We also have turn-key options available for both pin on and quick attach mounting. With these options your attachment arrives ready to go to work. For Pin on mounting use the worksheet to get the correct measurements so we can design and build it.

CARRIER	WEIGHT. (approx.)	CLASS	TON	WEDGE PRICE~	PIN-ON/PIN GRABBER PRICE~**	CROSS PIN PRICE~
Excavator	80 lbs	3	1.5 to 3	\$462	\$714**	\$928
Excavator	100 lbs	5	3 to 6	\$630	\$832**	\$1,081
Excavator	200 lbs	8	7 to 9	\$798	\$916**	\$1,190
Excavator	225 lbs	10	10 to 11	\$1,008	\$1,142**	\$1,485
Excavator	250 lbs	13	12 to 15	\$1,176	\$1,327**	\$1,725
Excavator	275 lbs	15	16 to 19	\$1,344	\$1,453**	\$1,889
Excavator	300 lbs	20	20 to 22	\$1,512	\$1,646**	\$2,140
Excavator	325 lbs	25	23 to 29	\$1,596	\$1,722**	\$2,239
Excavator	400 lbs	30	Over 30	Quote	Quote**	Quote

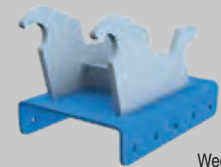

Wedge

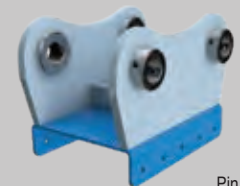

Pin On Grabber

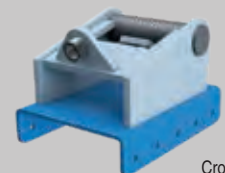

Cross Pin

~ Bolts not included if mount is ordered separately - See blank weld-on section above for prices on bolts

**Pins Not Included in Price.

Add 20% when not shipped with a whole good to get a free ride. Adaptor parts available without blank plate and unweld/unpainted for 50% off price shown

EXCAVATOR ADAPTOR PIN SIZES AND PRICES

PART NUMBER	CLASS	DIAMETER (mm)	TON	LIST PRICE (SET)
D003569	3	35-40	1.5 to 3	\$127**
D003569	5	45-50	3 to 6	\$175**
D003569	6	45-50	7 to 9	\$207**
D003569	8	45-55	10 to 11	\$233**
D003569	13	60-65	12 to 15	\$271**
D003569	15	65-80	16 to 19	\$334**
D003569	20	80	20 to 22	\$355**
D003569	25	80-90	23 to 29	\$434**
D003569	30	90-100	Over 30	\$493**

SOLD BY
EQUIPMENT DEALERS
FOR LOCAL SUPPORT



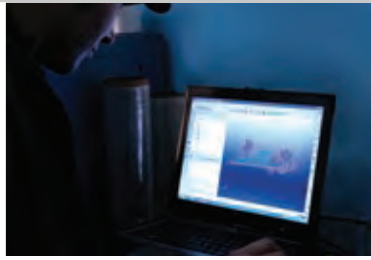

VISIT US ONLINE

LEARN MORE
baumalight.com

PIN-ON/PIN GRABBER COUPLER FORM

Pin On or Pin Grabber (Circle one)

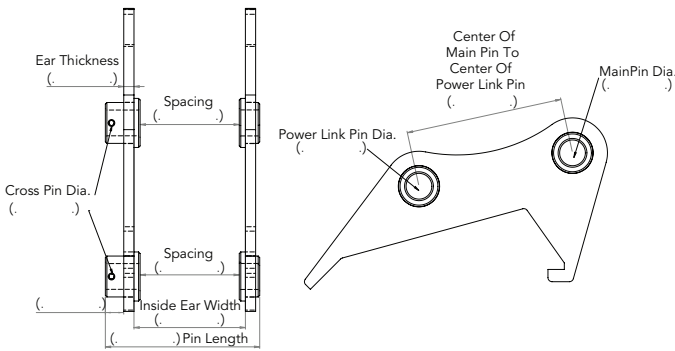

Please fill in all measurements

Check box If pins are required

WEDGE COUPLER AND CROSS PIN FORM

Please fill in all spaces below

Excavator Brand _____

Excavator Model _____

Coupler Brand _____

Coupler Model _____

Wedge Coupler, Cross Pin or Pin Grabber? _____

COLOR OPTIONS

PART #	COLOR OPTIONS	AVAILABLE FOR ANY BAUMALIGHT PRODUCTS*	PRICE
D001582	Green	Will increase lead-time	\$68
D001583	Orange	Take Number of Business Days	\$68
D001584	Blue	to build next order on	\$68
D001585	Red	www.suddenshipping.com	\$68

*up to 8 weeks extended lead time on some products

CHOOSE YOUR CUSTOM **COLOR**

Match the color of your favorite tractor company for the factory look! Additional cost and delivery lead time applicable

CONTACT YOUR DEALER TODAY!

SHIPPING POLICY

WHOLE GOODS FREIGHT

Baumalight whole good products include free freight to any non-remote Baumalight dealer in North America if no special arrangements are required for unloading. As of Jan 1 2021 Trailer plows and accessories no longer offered with free freight



PARTS SHIPPING

Parts orders over \$100 include free standard shipping to any non-remote location in North America if shipped standard. All orders under \$100 are subject to a \$20 flat rate shipping charge if shipped standard. Next Day Air or Express Courier rates are available at an additional cost for any value orders.

SOLD BY

EQUIPMENT DEALERS

FOR LOCAL SUPPORT

Most Tractor, Skidsteer or Excavator dealerships have access to the full line of Baumalight attachments.

Buy local through your Trusted Dealer for after-sales service, maintenance and product warranty.



THREE WAYS TO SAVE!



PRE-PRODUCTION TESTING



VIDEO/PHOTO SHOOTS



FLOOR AND DEMO MODELS

VISIT OUR WEBSITE FOR CURRENT FACTORY DISCOUNT OFFERS



Manufactured by: MTB MFG. INC.
4575 Powell Rd. Wallenstein, ON. Canada, N0B 2S0

1.866.820.7603 sales@baumalight.com
baumalight.com



CUMMINGS & BRICKER

www.cummingsandbricker.com
support@cummingsandbricker.com

Effective: 02/10/2021

F.O.B. C&B



[Click here for ordering programs - Select Program #9 From Bookmarks](#)

BAUMAN DROP SPREADERS

De-Ice Your Parking Lots, Driveways & Walkways

Bauman Sidewalk Sanders will dispense your de-icing material evenly in a pattern rather than in a solid layer. The distributor drum maintains the spread width to direct the material to drop exactly where you want it. This prevents material waste as well as turf damage from salt, both of which can be a problem with the spinner type spreaders.



Spread pattern



Agitator Bar

The agitator bar rotates in the hopper to reduce salt or sand from bridging and not passing through to the drum and then to the ground for an even application.



Finger Bar

A unique polymer finger bar with a flexible memory in very cold weather to retain its shape which gives an even cross hatch pattern when the material is dropped.



Salt Drum

For coarse salt distribution.
Bagged rock salt only.

Sand Drum

Rotating drum. **For sand, bulk rock salt, ice melters, and other various sized material.**



Electric Motor

¼ HP DC electric motor and reducer that drives the 440E and 1040SI drop sanders. The epoxy paint protects units from salt brine and slushy environment for long life.



Tension Lever

Included on all hydraulic units, flow control reduces hydraulic flow from tractor to the distribution drum.



Wiring Kit

A complete braided wiring harness is standard on the 440E and 1040SI electric models.



Flow Control

Included on all hydraulic units, flow control reduces the hydraulic flow from the tractor to the distribution drum. Allowing the operator to control distribution quantity.

Variable Speed Control

Allows an operator to control distribution quantity.



Standard on the 440E and 1040SI electric models.



220



440E/H



640



1140



1040SI



1040B



1560B

	220	440E/H	640	1140	1040SI	1040B	1560B
Capacity (cu. ft.)	2	4	6 ½	11	10	10	15
Spreading Width	20"	40"	40"	40"	40"	40"	60"
Spreading Distance (miles)	1	1.8	3.4	5.9	5.3	5.3	5.3
Tractor Size	NA	NA	20-40hp	20-60hp	NA	50-80hp	50-80hp
Overall Length	47"	17"	26"	33"	58"	33"	33"
Overall Width	30 ½"	47"	47"	47"	47"	49"	70"
Overall Height	NA	22"	26"	31 ½"	30"	26"	26"
Shipping Weight	90 lbs.	220 lbs.	290 lbs.	355 lbs.	300 lbs.	370 lbs.	525 lbs.
	20" wheels	Requires mounting brackets. Available with 3pt hitch or custom-made mounting bracket. Electric or Hydraulic available. Variable Speed Control	PTO or hydraulic drive (PTO shaft included)	PTO or hydraulic drive (PTO shaft included)	Fits 42" x 42" cargo box. Variable Speed Control	Requires mounting brackets. Available with 3pt hitch or custom-made mounting bracket. Other widths available.	Requires mounting brackets. Available with 3pt hitch or custom-made mounting bracket. Other widths available.

100-120 LEHIGH AVE.
P.O. BOX 928
BATAVIA, NY 14021
PHONE: 800-252-1552 FAX: 888-852-7406

100 STOVER DRIVE
CARLISLE, PA 17015
PHONE: 800-222-8969
FAX: 717-249-9384



CUMMINGS & BRICKER

www.cummingsandbricker.com
support@cummingsandbricker.com

Effective: 02/10/2021

F.O.B. C&B



BAUMAN
MANUFACTURING
BACKED BY A TRADITION OF QUALITY

220 SERIES PUSH TYPE

ITEMNUMBER	DESCRIPTION	WEIGHT	PRICE
220	Push Type with sand drum, 2 cubic feet capacity, 20" spreading width, Wheel driven, 20" Pnenmatic Wheels	90	\$1,660.00
220COVER	Hopper Cover For 220 Sander		\$102.00

220 Series EASY MANEUVERABILITY

Capacity: 2 cubic feet

Spreading Width: 20 inches



TOWABLE SPREADERS

ITEMNUMBER	DESCRIPTION	WEIGHT	PRICE
320T	Towable Drop Spreader - 3CF Capacity, 20" Spread Width-Sand Drum	250	\$2,514.00
430T	Towable Drop Spreader - 9CF Capacity, 30" Spread Width-Sand Drum	165	\$3,659.00
320LID	Hopper Cover - Hinged, Galvanized For 320T		\$167.00
430LID	Hopper Cover - Hinged, Galvanized For 430T		\$167.00

320T Series Towable

Capacity: 3 cubic feet

Spreading Width: 20 inches

Estimated Spread Distance: 1.25 miles

Sand Drum

430T Series Towable

Capacity: 9 cubic feet

Spreading Width: 30 inches

Estimated Spread Distance: 2.5 miles

Sand Drum





CUMMINGS & BRICKER

www.cummingsandbricker.com
support@cummingsandbricker.com

Effective: 02/10/2021

F.O.B. C&B



440 SERIES

Choosing which style drum: **SALT DRUM** is only to be used with bagged rock salt. **SAND DRUM** should be used for sand, bulk rock salt, ice melters, various sized material, or any other material.

440 SERIES

ITEMNUMBER	DESCRIPTION	WEIGHT	PRICE
440ESALT	Electric Drive w/salt drum (Requires mounting bracket) 4 cu. ft. capacity, 40" spreading width, 12 volt electric motor. WIRING KIT FROM SPREADER TO BATTERY IS INCLUDED.	220	\$3,580.00
440ESAND	Electric drive w/sand drum (Requires mounting bracket) 4 cu. ft. capacity, 40" spread width 12 volt electric motor electric. WIRING KIT FROM SPREADER TO BATTERY IS INCLUDED.	220	\$3,580.00
440HSALT	Hydraulic Drive W/Flow Control, Salt Drum, Spreader 4 cu. ft. capacity, 40" Spread Width. HOSES, PIONEER ENDS, & FLOW CONTROL ARE INCLUDED.	220	\$3,580.00
440HSAND	Hydraulic Drive W/Flow Control, Sand Drum, Spreader 4 cu. ft. capacity, 40" Spread Width. HOSES, PIONEER ENDS, & FLOW CONTROL ARE INCLUDED.	220	\$3,580.00

440E OPTIONS

ITEMNUMBER	DESCRIPTION	PRICE
BRACKET3PT440	3 Point Hitch Bracket For 440E	\$595.00
BRACKET440	2" Square Receiver Hitch Bracket - For 440E	\$441.00
BRACKET4100	Bracket For Ventrac 4100-440E	\$504.00
JD700440E	Bracket For John Deer X700 Click N Go - 440E	\$315.00
440COVER	Hopper Cover For 440E Sander	\$102.00
440LID	Hopper Cover - Galvanized Lid For 440E/H	\$182.00
1801440WIRE	Wire Harness - Pre 2017 Spreaders Bauman Electric Spreaders	\$107.00
1801440CONTROL	Variable Speed Electronic Control For Electric Spreaders 2017 Units Or Newer	\$416.00

440 Series

Capacity: 4 cubic feet

Spreading Width: 40 inches

Estimated Spread Distance: 1.75 miles

12 volt Electric or Hydraulic Drive

For Compact Tractors

Variable Speed Control and wiring harness included on electric models



VENTRAC MOUNTING BRACKET SHOWN



100-120 LEHIGH AVE.
P.O. BOX 928
BATAVIA, NY 14021
PHONE: 800-252-1552 FAX: 888-852-7406

100 STOVER DRIVE
CARLISLE, PA 17015
PHONE: 800-222-8969
FAX: 717-249-9384



CUMMINGS & BRICKER

www.cummingsandbricker.com
support@cummingsandbricker.com

Effective: 02/10/2021

F.O.B. C&B



Choosing which style drum: **SALT DRUM** is only to be used with bagged rock salt. **SAND DRUM** should be used for sand, bulk rock salt, ice melters, various sized material, or any other material.

640 SERIES

ITEMNUMBER	DESCRIPTION	WEIGHT	PRICE
640PSALT	3PH PTO driven w/salt drum -6.25 cu. ft. capacity & 40" spread (same specifications as 1140P). With PTO shaft	290	\$4,617.00
640PSAND	PTO driven w/sand drum -6.25 cu. ft. capacity (same specifications as 1140P). With PTO shaft.	290	\$4,617.00
640HSALT	3PH Hydraulic driven w/salt drum and flow control - 40" spread & 6.25 cu. ft. capacity (same specifications as 1140H). HYDRAULIC HOSES NOT INCLUDED.	290	\$4,617.00
640HSAND	Hydraulic Driven w/ sand drum - 6.25 cu. ft. capacity (same specifications as 1140H). HYDRAULIC HOSES NOT INCLUDED.	290	\$4,617.00

640 AND 1140 OPTIONS

ITEMNUMBER	DESCRIPTION	PRICE
640EXT	Extension-Increases Capacity From 6.25 Cu.Ft. To 8.75 Cu. Ft.	\$391.00
640EXT12	Extension 12" - Increases Capacity From 6.25 Cu. Ft. To 11.25 Cu. Ft.	\$391.00
1140EXT	Extension- Increases Capacity From 11 Cu. Ft. To 16 Cu. Ft.	\$391.00
BRACKET3PTSSL	Bracket For Skid Steer Loader 640H/1140H	\$624.00
640COVER	Hopper Cover For 640 Sander	\$108.00
1140COVER	Hopper Cover For 1140 Sander	\$120.00
640LID	Hopper Cover Hinged-Galvanized 640H/P Spreader	\$189.00
1140LID	Hopper Cover Hinged Galvanized 1140H/P Spreaders	\$199.00

640 Series PTO, HYDRAULIC OR ELECTRIC DRIVE

- Capacity: 6 1/2 cubic feet
- Extension Capacity: 8 3/4 cubic feet
- Spreading Width: 40 inches
- Estimated Spread Distance: 3.25 miles



Galvanized Hinged Hopper Cover – Available on 640/1140 Series

960 SERIES SPREADER

ITEMNUMBER	DESCRIPTION	WEIGHT	PRICE
960HSAND	3PH Hydraulic driven - 60" Spread Pattern, 9 CF Capacity-Sand Drum-W/ Flow Control	440	\$5,028.00
960COVER	Hopper Cover - Soft For 960H		\$135.00
960LID	Hopper Cover - Hinged Galvanized For 960H		\$199.00

960 Series

- Capacity: 9 cubic feet
- Spreading Width: 60 inches
- Sand Drum



100-120 LEHIGH AVE.
P.O. BOX 928
BATAVIA, NY 14021
PHONE: 800-252-1552 FAX: 888-852-7406

100 STOVER DRIVE
CARLISLE, PA 17015
PHONE: 800-222-8969
FAX: 717-249-9384



CUMMINGS & BRICKER

www.cummingsandbricker.com
support@cummingsandbricker.com

Effective: 02/10/2021

F.O.B. C&B



1140 SERIES

ITEMNUMBER	DESCRIPTION	WEIGHT	PRICE
1140PSALT	PTO driven w/salt drum-11 cu. ft. capacity, 40" spreading width, Fixed cams on drum, 3-point hitch mount to fit most popular makes of mid size tractors with 540 PTO. With PTO shaft.	355	\$5,002.00
1140PSAND	PTO driven w/sand drum-11 cu. ft. capacity, 40" spreading width, Fixed cams on drum, 3-point hitch mount to fit most popular makes of mid size tractors with 540 PTO. With PTO shaft.	355	\$5,002.00
1140HSALT	Hydraulic driven w/sand drum & flow control - 11 cu. ft. capacity, 40" spreading width, Fixed cams on drum, 3-point hitch mount to fit most popular makes of mid size tractors equipped with hydraulic system with an output of 900 PSI and a flow of 6-8 GPM. HYDRAULIC HOSES NOT INCLUDED	355	\$5,002.00
1140HSAND	Hydraulic driven w/sand drum - 11 cu. ft. capacity, 40" spreading width, Fixed cams on drum, 3-point hitch mount to fit most popular makes of mid size tractors equipped with hydraulic system with an output of 900 PSI and a flow of 6-8 GPM. HYDRAULIC HOSES NOT INCLUDED		\$5,002.00

1140 Series PTO OR HYDRAULIC DRIVE

Capacity: 11 cubic feet

Extension Capacity: 16 cubic feet

Spreading Width: 40 inches



Choosing which style drum: **SALT DRUM** is only to be used with bagged rock salt. **SAND DRUM** should be used for sand, bulk rock salt, ice melters, various sized material, or any other material.

1040 SERIES

ITEMNUMBER	DESCRIPTION	WEIGHT	PRICE
1040BSALT	Self-Loading Bucket Hydraulic Drive Sand Drum (Requires mounting bracket) 10 cubic foot capacity, 40"spreading width, Equiped with a flow control. HYDRAULIC HOSES NOT INCLUDED. ADD BRACKET	370	\$5,152.00
1040BSAND	Self-Loading Bucket Hydraulic Drive Sand Drum (Requires mounting bracket) 10 cubic foot capacity, 40"spreading width, Equiped with a flow control. HYDRAULIC HOSES NOT INCLUDED	370	\$5,152.00
1040SISALT	Slide-In with salt drum, 10 cubic foot capacity, 40"spreading width, electric drive. WIRING KIT FROM SPREADER TO BATTERY IS INCLUDED.	300	\$5,434.00
1040SISAND	Slide-In with sand drum, 10 cubic foot capacity, 40"spreading width, electric drive. WIRING KIT FROM SPREADER TO BATTERY IS INCLUDED.		\$5,434.00

1040SI – FOR UTILITY VEHICLES

Designed to work with many utility vehicles. Fits 42" x 42" cargo box

Capacity: 10 cubic feet

Spreading Width: 40 inches

Electric drive

Variable Speed Control and wiring harness included on electric models



100-120 LEHIGH AVE.
P.O. BOX 928
BATAVIA, NY 14021
PHONE: 800-252-1552 FAX: 888-852-7406

100 STOVER DRIVE
CARLISLE, PA 17015
PHONE: 800-222-8969
FAX: 717-249-9384



CUMMINGS & BRICKER

www.cummingsandbricker.com
support@cummingsandbricker.com

Effective: 02/10/2021

F.O.B. C&B



Choosing which style drum: **SALT DRUM** is only to be used with bagged rock salt. **SAND DRUM** should be used for sand, bulk rock salt, ice melters, various sized material, or any other material.

1560 SERIES

ITEMNUMBER	DESCRIPTION	WEIGHT	PRICE
1560BSALT	Self-Loading Bucket with salt drum (Requires mounting bracket) 15 cubic foot capacity, 60" spreading width, Hydraulic drive, Equipped with a flow control. HYDRAULIC HOSES NOT INCLUDED. ADD BRACKET	525	\$6,003.00
1560BSAND	Self-Loading Bucket with sand drum (Requires mounting bracket) 15 cubic foot capacity, 60" spreading width, Hydraulic drive, Equipped with a flow control. HYDRAULIC HOSES NOT INCLUDED. ADD BRACKET	525	\$6,003.00

1040B AND 1560B OPTIONS

ITEMNUMBER	DESCRIPTION	WEIGHT	PRICE
BRACKET3PTTILT	Tilting 3 Point Hitch Bracket For 1040B And 1560B	160	\$2,245.00
BRACKETALO	ALO (Global/Euro) Bracket For 1040B /1560B		\$624.00
BRACKETSSLB	Skid Loader Bracket For 1040B & 1560B		\$624.00
1040SICOVER	Hopper Cover For 1040SI Sander		\$135.00
1801440CONTROLSI	Variable Speed Electronic Control For Electric Spreaders 2017 Units Or Newer		\$416.00
1801440WIRESI	Wire Harness - Pre 2017 Spreaders Bauman Electric Spreaders		\$107.00

1040B & 1560B Series HYDRAULIC DRIVE

Equipped with hydraulic flow control valve

1040B

Capacity: 10 cubic feet
Spreading Width: 40 inches

1560B

Capacity: 15 cubic feet
Spreading Width: 60 inches

**shown with optional 3 point hitch tilting bracket*





HAY FLUFFER TEDDER



Key Features

- Heavy Duty Five Bat Reel Design
- Sealed Bearings
- Spring Tines
- Nylon Cam Rollers
- Precision Depth Adjustment
- Easy Tine Angle Adjustment
- Fully Assembled
- Standard Jack Stand

Models Available

- PTO Drive
- Hydraulic Drive
- Hydraulic Reel Lift
- Ground Drive

Options

- Tandem Wheels
- Hydraulic Reel Lift



Precision Depth Adjustment



Easy Tine Angle Adjustment



Heavy Duty Reel



Optional Tandem Wheels



HAY FLUFFER TEDDER

The **Bauman** Hay Fluffer Tedder is designed to gently lift and release hay with minimal leaf damage. The Fluffer Tedder allows air to move through hay and gives additional windrow height for faster drying time. The result is better control over how hay dries and a uniform cure.



BAUMAN
MANUFACTURING
BACKED BY A TRADITION OF QUALITY

PRICE LIST

Model #	Description	Weight (lbs.)	Price
5710	7' PTO Drive, Single Wheel	925 lbs.	\$5,534.00
5710T	7' PTO Drive, Tandem Wheel	987 lbs.	\$6,318.00
5710L	7' PTO Drive, Hydraulic Reel Lift	1120 lbs.	\$7,402.00
5710LT	7' PTO Drive, Hydraulic Lift, Tandem Wheel	1182 lbs.	\$8,187.00
5710H	7' Hydraulic Drive	925 lbs.	\$5,534.00
5710HT	7' Hydraulic Drive, Tandem Wheel	987 lbs.	\$6,318.00
5710HL	7' Hydraulic Drive, Hydraulic Reel Lift	1120 lbs.	\$7,402.00
5710HLT	7' Hydraulic Drive, Hydraulic Reel Lift, Tandem Wheel	1182 lbs.	\$8,187.00
5710GD	7' Ground Drive	925 lbs.	\$5,534.00
5910	9' PTO Drive	985 lbs.	\$5,919.00
5910T	9' PTO Drive, Tandem Wheel	1047 lbs.	\$6,705.00
5910L	9' PTO Drive, Hydraulic Reel Lift	1180 lbs.	\$7,789.00
5910LT	9' PTO Drive, Hydraulic Reel Lift, Tandem Wheel	1242 lbs.	\$8,573.00
5910H	9' Hydraulic Drive	985 lbs.	\$5,919.00
5910HT	9' Hydraulic Drive, Tandem Wheel	1047 lbs.	\$6,705.00
5910HL	9' Hydraulic Drive, Hydraulic Reel Lift	1180 lbs.	\$7,789.00
5910HLT	9' Hydraulic Drive, Hydraulic Reel Lift, Tandem Wheel	1242 lbs.	\$8,647.00
5910 Tandem	Tandem Kit only		\$1,122.00



11" SINGLE CHAIN CONVEYOR



BAUMAN
MANUFACTURING
BACKED BY A TRADITION OF QUALITY



Construction Features:

- 14 ga. galvanized steel body
- 5-1/4" trough depth
- 11" body depth
- Gear reducer drive
- 667H pintle chain is standard
- 2-1/2" high rubber flights

Operating Features:

- Approximately 90' per minute chain speed
- 18" drive unit, 18" idle unit
- Lengths include 4', 5' and 7' body sections or any multiple thereof

Options:

- Adjustable stand with wheels
- Custom hoppers
- Discharge spout

 **Made in Canada**



CONVEYOR

11" SINGLE CHAIN

667H Pintle chain

SECTIONS INCLUDED

Price	PART #	LENGTH	Price	DRV	IDLE	4ft	5ft	7ft	EST. HP
				18"	18"	48"	60"	84"	
	02806Nx3	3 ft.	\$ 1,526.00	1	1				1/2
Standard:	02806Nx7	7 ft.	\$ 1,838.00	1	1	1			1/2
Drive Assembly with Chain	02806Nx8	8 ft.	\$ 1,864.00	1	1		1		1/2
02806N-DRIVE GR-A \$1,017.00	02806Nx10	10 ft.	\$ 1,998.00	1	1			1	1/2
Idle Assembly with Chain	02806Nx12	12 ft.	\$ 2,175.00	1	1	1	1		1/2
02806N-IDLE-A \$ 510.00	02806Nx13	13 ft.	\$ 2,201.00	1	1		2		1/2
4' Section with Chain	02806Nx14	14 ft.	\$ 2,310.00	1	1	1		1	1/2
02806Nx04A \$ 311.00	02806Nx15	15 ft.	\$ 2,336.00	1	1		1	1	3/4
5' Section with Chain	02806Nx17	17 ft.	\$ 2,470.00	1	1			2	3/4
02806Nx05A \$ 472.00	02806Nx18	18 ft.	\$ 2,539.00	1	1		3		3/4
7' Section with Chain	02806Nx19	19 ft.	\$ 2,647.00	1	1	1	1	1	3/4
02806Nx07A \$ 472.00	02806Nx20	20 ft.	\$ 2,673.00	1	1		2	1	3/4
	02806Nx21	21 ft.	\$ 2,782.00	1	1	1		2	3/4
Options:	02806Nx22	22 ft.	\$ 2,808.00	1	1		1	2	3/4
Hopper	02806Nx23	23 ft.	\$ 2,876.00	1	1		4		1
02806N-HOPPER \$ 63.00	02806Nx24	24 ft.	\$ 2,942.00	1	1			3	1
Bend	02806Nx25	25 ft.	\$ 3,011.00	1	1		3	1	1
02806N-BEND \$ 660.00	02806Nx26	26 ft.	\$ 3,119.00	1	1	1	1	2	1
Discharge Spout	02806Nx27	27 ft.	\$ 3,187.00	1	1	1	4		1
02806-SPOUT \$ 173.00	02806Nx28	28 ft.	\$ 3,254.00	1	1	1		3	1
Cover /ft.	02806Nx29	29 ft.	\$ 3,322.00	1	1	1	3	1	1
02806N-COVER \$ 13.00	02806Nx30	30 ft.	\$ 3,348.00	1	1		4	1	1
Adjustable stand on wheels	02806Nx31	31 ft.	\$ 3,456.00	1	1	1	2	2	1-1/2
02806N-U/C \$1,084.00	02806Nx32	32 ft.	\$ 3,482.00	1	1		3	2	1-1/2
	02806Nx33	33 ft.	\$ 3,591.00	1	1	1	1	3	1-1/2
NOTES:	02806Nx34	34 ft.	\$ 3,659.00	1	1	1	4	1	1-1/2
Motor is extra.	02806Nx35	35 ft.	\$ 3,726.00	1	1	1		4	1-1/2
Requires C-face motor.	02806Nx36	36 ft.	\$ 3,794.00	1	1	1	3	2	1-1/2
Conveyor incline, material density and volume will affect horsepower required.	02806Nx37	37 ft.	\$ 3,902.00	1	1	2	1	3	1-1/2
HP shown is estimated for 30 degree incline and feed ration.	02806Nx38	38 ft.	\$ 3,886.00	1	1			5	1-1/2
	02806Nx39	39 ft.	\$ 4,037.00	1	1	2		4	1-1/2
	02806Nx40	40 ft.	\$ 4,063.00	1	1	1	1	4	1-1/2
	02806Nx41	41 ft.	\$ 4,089.00	1	1		2	4	1-1/2
	02806Nx42	42 ft.	\$ 4,240.00	1	1	2	2	3	1-1/2
	02806Nx43	43 ft.	\$ 4,266.00	1	1	1	3	3	1-1/2
	02806Nx44	44 ft.	\$ 4,374.00	1	1	2	1	4	1-1/2
	02806Nx45	45 ft.	\$ 4,400.00	1	1	1	2	4	1-1/2



BAUMAN

MANUFACTURING



18" DOUBLE CHAIN CONVEYOR



Construction Features:

- 14 ga. galvanized steel body
- 12 ga. galvanized floor
- 5-1/4" trough depth
- 11" body depth
- Gear reducer drive
- #662 chain is standard
- 2-1/2" high rubber flights

Operating Features:

- Approximately 90' per minute chain speed
- 18" drive unit, 18" idle unit
- Lengths include 4', 5' and 7' body sections or any multiple thereof

Options:

- Adjustable stand with wheels
- Custom hoppers
- Discharge spout
- 18" angled incline with 662 pintle chain
- Caster wheel kit for incline model



🇨🇦 Made in Canada





CONVEYOR

18" DOUBLE CHAIN

SECTIONS INCLUDED

662 Pintle Chain 2-1/2" Flight every 16"					DRV	IDLE	4ft	5ft	7ft	EST.
					18"	18"	48"	60"	84"	HP
Price	PART #	LENGTH	Price							
	02807x3	3 ft.	\$ 1,865.00		1	1				1/2
Standard:	02807x7	7 ft.	\$ 2,469.00		1	1	1			1/2
Drive Assembly with Chain	02807x8	8 ft.	\$ 2,600.00		1	1		1		1/2
02807-DRIVE GR-A \$ 1,118.00	02807x10	10 ft.	\$ 2,763.00		1	1			1	1/2
Idle Assembly with Chain	02807x12	12 ft.	\$ 3,205.00		1	1	1	1		1/2
02807-IDLE-A \$ 747.00	02807x13	13 ft.	\$ 3,336.00		1	1		2		3/4
4' Section with Chain	02807x14	14 ft.	\$ 3,368.00		1	1	1		1	3/4
02807x04A \$ 604.00	02807x15	15 ft.	\$ 3,499.00		1	1		1	1	3/4
5' Section with Chain	02807x17	17 ft.	\$ 3,662.00		1	1			2	3/4
02807x05A \$ 735.00	02807x18	18 ft.	\$ 4,071.00		1	1		3		3/4
7' Section with Chain	02807x19	19 ft.	\$ 4,103.00		1	1	1	1	1	3/4
02807x07A \$ 898.00	02807x20	20 ft.	\$ 4,234.00		1	1		2	1	1
	02807x21	21 ft.	\$ 4,266.00		1	1	1		2	1
Options:	02807x22	22 ft.	\$ 4,397.00		1	1		1	2	1
Hopper	02807x23	23 ft.	\$ 4,806.00		1	1		4		1
02807-HOPPER \$ 76.00	02807x24	24 ft.	\$ 4,560.00		1	1			3	1
Bend	02807x25	25 ft.	\$ 4,966.00		1	1		3	1	1
02807-BEND A \$ 804.00	02807x26	26 ft.	\$ 5,001.00		1	1	1	1	2	1
Discharge Spout	02807x27	27 ft.	\$ 5,410.00		1	1	1	4		1-1/2
02807-SPOUT \$ 277.00	02807x28	28 ft.	\$ 5,164.00		1	1	1		3	1-1/2
Cover/ft.	02807x29	29 ft.	\$ 5,573.00		1	1	1	3	1	1-1/2
02807-COVER \$ 15.00	02807x30	30 ft.	\$ 5,705.00		1	1		4	1	1-1/2
Adjustable stand on wheels	02807x31	31 ft.	\$ 5,736.00		1	1	1	2	2	1-1/2
02807-STAND \$ 1,307.00	02807x32	32 ft.	\$ 5,868.00		1	1		3	2	1-1/2
	02807x33	33 ft.	\$ 5,900.00		1	1	1	1	3	1-1/2
	02807x34	34 ft.	\$ 6,309.00		1	1	1	4	1	1-1/2
	02807x35	35 ft.	\$ 6,063.00		1	1	1		4	1-1/2
	02807x36	36 ft.	\$ 6,472.00		1	1	1	3	2	1-1/2
	02807x37	37 ft.	\$ 6,504.00		1	1	2	1	3	1-1/2
	02807x38	38 ft.	\$ 6,357.00		1	1			5	1-1/2
	02807x39	39 ft.	\$ 6,667.00		1	1	2		4	1-1/2
	02807x40	40 ft.	\$ 6,798.00		1	1	1	1	4	2
	02807x41	41 ft.	\$ 6,929.00		1	1		2	4	2
	02807x42	42 ft.	\$ 7,239.00		1	1	2	2	3	2
	02807x43	43 ft.	\$ 7,370.00		1	1	1	3	3	2
	02807x44	44 ft.	\$ 7,402.00		1	1	2	1	4	2
	02807x45	45 ft.	\$ 7,533.00		1	1	1	2	4	2

NOTES:

Motor is extra.
Requires C-face motor.

Conveyor incline, material density and volume will affect horsepower required.

HP shown is estimated for 30 degree incline and feed ration.





FIREWOOD CONVEYOR



Construction Features:

- 12 ga. heavy duty 5' bottom section
- 8" wide trough flared out to 18" at top
- 8" deep trough
- Flared style trough conveyor
- Standard hopper included 32" wide
- Heavy conveyor chain (662 pintle)
- 2" high serrated chain flight
- Easy bolt together construction

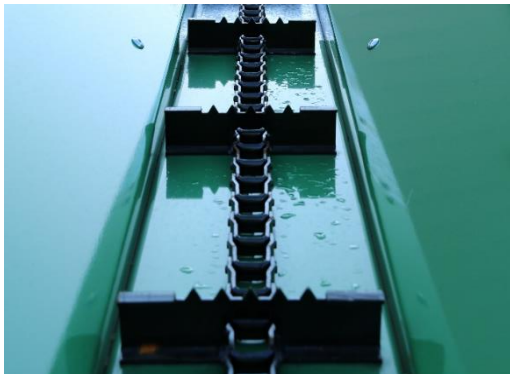

100-120 Lehigh Ave. | P.O. BOX 928
Batavia, NY 14020
PHONE: 800-252-1552 | FAX: 888-852-7406

Operating Features:

- Handles firewood and similar types of material
- Available 20', 25' & 30' lengths

Options:

- Optional undercarriage allows for easy transportation and height adjustment
- Hydraulic or electric drive
- Hydraulic power pack

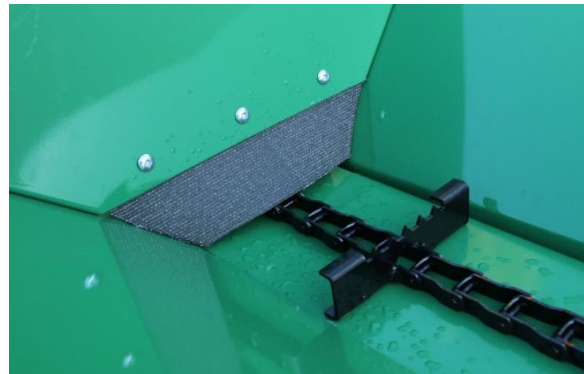

100 Stover Drive
Carlisle, PA 17015
PHONE: 800-222-9869 | FAX: 717-249-9384



FIREWOOD CONVEYOR

Price

02808x10' ELECTRIC

10' unit (no undercarriage) with electric motor..... \$ 2,616.00

02808x10' HYDRAULIC

10' unit (no undercarriage) with hydraulic motor (no hoses)..... \$ 2,616.00

02808x15' ELECTRIC

15' unit - (no undercarriage) with electric motor..... \$ 2,991.00

02808x15' HYDRAULIC

15' unit - (no undercarriage) with hydraulic motor (no hoses)..... \$ 2,991.00

02808x20' ELECTRIC

20' unit - (no undercarriage) with electric motor..... \$ 3,490.00

02808x20' HYDRAULIC

20' unit - (no undercarriage) with hydraulic motor (no hoses)..... \$ 3,490.00

02808x25' ELECTRIC

25' unit - (no undercarriage) with electric motor..... \$ 3,813.00

02808x25' HYDRAULIC

25' unit - (no undercarriage) with hydraulic motor (no hoses)..... \$ 3,813.00

02808x30' ELECTRIC

30' unit - (no undercarriage) with electric motor..... \$ 4,112.00

02808x30' HYDRAULIC

30' unit - (no undercarriage) with hydraulic motor (no hoses)..... \$ 4,112.00

02808-U/C ASSY

Undercarriage only with winch, tires and towing hitch - for 20' to 30' units only..... \$ 1,683.00





MAPLE LEAF TUBULAR BALE ELEVATOR



Construction Features:

- Steel square tube frame
- Gear reducer drive
- #55 H B4 chain
- Standard 20' basic unit, 6' and 10' extensions available
- Easy to assemble, bolt together construction
- Lightweight and easy to transport

Operating Features:

- Ideal for agricultural and commercial applications
- Light and easy to handle

Options:

- Optional undercarriage allows for easy transportation and height adjustment
- Various sizes of electric motors available





MAPLE LEAF TUBULAR BALE ELEVATOR

Price

03700x20B

20' basic unit - complete with gear box drive (No undercarriage and motor is not included)..... \$1,588.00

03700x06A

6' extension for 20' basic unit..... \$ 327.00

03700x10A

10' extension for 20' basic unit..... \$ 522.00

03700 U/C AREG

Standard duty undercarriage with winch, tires and towing hitch for 26' to 32' units..... \$2,009.00

03701 UCAHD

Heavy duty undercarriage with winch tires and towing hitch for 36' to 48' units..... \$2,456.00

03700 026

Bale chute..... \$ 428.00



AVAILABLE LENGTHS

LGTH	ELEVATOR ONLY			ACTUAL LENGTH	ELEVATING HEIGHT	MOTOR SIZE	*ELEVATOR WITH U/C & HITCH		
	PART NO.	PRICE	**WEIGHT				PART NO.	PRICE	**WEIGHT
20 ft.	03700x20B	\$ 1,588.00	207 lbs.	19.5 ft.	11.0 ft.	1/2 hp	N/A	N/A	N/A
26 ft.	03700x26	\$ 1,915.00	327 lbs.	25.9 ft.	15.0 ft.	3/4 hp	03700x26 U/C	\$4,095.00	677 lbs.
30 ft.	03700x30	\$ 2,110.00	354 lbs.	29.3 ft.	18.0 ft.	3/4 hp	03700x30 U/C	\$4,290.00	704 lbs.
32 ft.	03700x32	\$ 2,242.00	389 lbs.	32.3 ft.	20.0 ft.	3/4 hp	03700x32 U/C	\$4,422.00	739 lbs.
36 ft.	03700x36	\$ 2,437.00	417 lbs.	35.7 ft.	21.0 ft.	3/4 hp	03700x36 U/C	\$5,064.00	917 lbs.
40 ft.	03700x40	\$ 2,632.00	444 lbs.	39.0 ft.	24.0 ft.	1 hp	03700x40 U/C	\$5,259.00	944 lbs.
42 ft.	03700x42	\$ 2,765.00	480 lbs.	42.1 ft.	26.0 ft.	1 hp	03700x42 U/C	\$5,391.00	980 lbs.
46 ft.	03700x46	\$ 2,596.00	507 lbs.	45.4 ft.	28.0 ft.	1 hp	03700x46 U/C	\$5,586.00	1007 lbs.
50 ft.	03700x50	\$ 3,154.00	535 lbs.	48.8 ft.	30.0 ft.	1 hp	03700x50 U/C	\$5,781.00	1035 lbs.

* INCLUDES HITCH AND SETUP CHARGE OF \$150.00

**WEIGHT DOES NOT INCLUDE "C" FACE MOTOR WEIGHT, IF PURCHASED

TECHTOP HIGH TORQUE MOTOR, 56C ROUND BODY

HP	PART NO.	RPM	PRICE
1/2	1801 602210-C	1800	\$363.00
3/4	1801 602211-C	1800	\$397.00
1	1801 602212-C	1800	\$450.00





EBERSOL BALE ELEVATOR



Construction Features:

- Galvanized sheet metal
- V-Belt drive with #55 chain reduction
- Flared sides and hopper
- Pre-lubricated self-aligning bearings
- Heavy-duty undercarriage allows easy transportation and height adjustment

Operating Features:

- Handles bales, grain, corn cobs, silage, etc.
- Top drive pulls load rather than pushing it

Options:

- Winch conversion kit
- Corn screen

SPECIFICATION CHART

Model	Length	Approx. Height	Axle	Weight	Motor	Miscellaneous -- all sizes
24'	26'	21'	6'	935 lbs	3/4 hp	<ul style="list-style-type: none"> • Trough width at bottom - 20" • Trough width at top - 27" • Depth of straight trough - 4-1/2" • Depth of flared trough - 6" • Total depth of trough - 10-1/2" • Flight spacing - 2'4'/6" (4' standard)
28'	30'	23'	7'	1090 lbs	1 hp	
32'	34'	25'	7'	1195 lbs	1 hp	
36'	38'	28'	7'	1352 lbs	1-1/2 hp	
40'	42'	29'	7'	1510 lbs	1-1/2 hp	
48'	50'	38'	8'	1840 lbs	2 hp	

EBERSOL BALE ELEVATOR

Standard Equipment:

V-Belt, elevator pulley, chain, motor mount, wood wear strips, undercarriage, tires on rims and tow hitch

Price Per Unit - Set Up Included

	PRICE
03900 EBERSOL 2400	
24' unit.....	\$ 6,534.00
03900 EBERSOL 2800	
28' unit.....	\$ 6,948.00
03900 EBERSOL 3200	
32' unit.....	\$ 7,478.00
03900 EBERSOL 3600	
36' unit.....	\$ 7,912.00
03900 EBERSOL 4000	
40' unit.....	\$ 8,680.00
03900 EBERSOL 4800	
48' unit.....	\$ 9,860.00



Optional Equipment

	PRICE
03900 WK	
Winch conversion kit.....	\$ 602.00
1055 EBERSOL	
Extra flight	\$ 26.00



EBERSOL BELT CONVEYOR



Shown with optional undercarriage

Construction Features:

- 16 ga. galvanized body construction
- Gear reducer with sprockets and chain
- 8-1/2" body depth
- Available in 1' length increments
- Belt troughing in slider bed
- Hopper
- PVC crescent top belt is standard
- 1/2 - 3PH motor (based on length of unit ordered) *NOTE - HD drive required on units that require a 3 PH motor

Operating Features:

- Self cleaning idler pulley
- 230' per minute belt speed
- Up to 30 degree conveying incline

Options:

- 14", 18" and 24" widths available
- Galvanized sides with skirting
- Galvanized cover
- Belt scraper
- Discharge spout
- Heavy duty undercarriage with braking safety winch, tires and towing hitch
- Textured or smooth top belts
- Hydraulic power pack

Notes:

- Conveyor length for 30 degrees incline is determined by multiplying the discharge height by 2.
- Example: For a discharge height of 10', a 20' conveyor would be required for a 30 degree incline.



14" BELT CONVEYOR WITH HOPPER

Options:	02805 SCRAPER	Belt Scraper	\$171.00
Price does not include motor	02805 COVER 14	Cover / ft.	\$15.00
Requires C-face motor	02805 DS14	Discharge spout	\$296.00
	02805 DRIVE HD	HD drive required for 3 hp motor	\$998.00

NOTE:

Estimated capacity (no elevation): 35 Tons per hour @ 60 lbs / bushel
Optional sides available. Addition of sides may change the horsepower requirements.

* Motor sized for incline of 0 degrees.

Length (feet) nominal	Over All	Shaft Centres (Inches)	Motor Hp *	Price Crescent Belt	ESTIMATED WEIGHT (lbs) (no sides)	OPTIONAL SIDES ADD \$	Motor Hp *	ESTIMATED WEIGHT (lbs) (with sides)
6	6 ft. 7 ins.	75	1/2	\$2,655.06	220	\$174.42	1/2	261
7	7 ft. 7 ins.	87	1/2	\$2,868.24	249	\$224.58	1/2	298
8	8 ft. 7 ins.	99	1/2	\$2,772.48	243	\$239.40	1/2	300
9	9 ft. 7 ins.	111	1/2	\$2,951.46	269	\$285.00	1/2	335
10	10 ft. 7 ins.	123	1/2	\$3,011.88	282	\$314.64	1/2	355
11	11 ft. 7 ins.	135	1/2	\$3,011.88	276	\$327.18	1/2	358
12	12 ft. 7 ins.	147	1/2	\$3,114.48	302	\$381.90	1/2	392
13	13 ft. 7 ins.	159	1/2	\$3,192.00	317	\$411.54	1/2	415
14	14 ft. 7 ins.	171	1/2	\$3,234.18	327	\$437.76	1/2	433
15	15 ft. 7 ins.	183	1/2	\$3,309.42	340	\$477.66	1/2	454
16	16 ft. 7 ins.	195	1/2	\$3,337.92	350	\$497.04	1/2	472
17	17 ft. 7 ins.	207	1/2	\$3,535.14	376	\$549.48	1/2	507
18	18 ft. 7 ins.	219	1/2	\$3,455.34	372	\$564.30	1/2	511
19	19 ft. 7 ins.	231	1/2	\$3,637.74	399	\$608.76	3/4	546
20	20 ft. 7 ins.	243	3/4	\$3,681.06	409	\$638.40	3/4	564
21	21 ft. 7 ins.	255	3/4	\$3,602.40	405	\$650.94	3/4	569
22	22 ft. 7 ins.	267	3/4	\$3,829.26	434	\$715.92	3/4	606
23	23 ft. 7 ins.	279	3/4	\$3,857.76	444	\$735.30	3/4	624
24	24 ft. 7 ins.	291	3/4	\$3,918.18	457	\$761.52	3/4	645
25	25 ft. 7 ins.	303	3/4	\$3,959.22	467	\$791.16	3/4	663
26	26 ft. 7 ins.	315	3/4	\$4,005.96	477	\$820.80	3/4	681
27	27 ft. 7 ins.	327	3/4	\$4,231.68	505	\$885.78	3/4	718
28	28 ft. 7 ins.	339	3/4	\$4,137.06	502	\$889.20	3/4	723
29	29 ft. 7 ins.	351	3/4	\$4,349.10	528	\$953.04	1	757
30	30 ft. 7 ins.	363	1	\$4,361.64	538	\$962.16	1	775
31	31 ft. 7 ins.	375	1	\$4,284.12	535	\$974.70	1	780
32	32 ft. 7 ins.	387	1	\$4,496.16	561	\$1,038.54	1	814
33	33 ft. 7 ins.	399	1	\$4,524.66	571	\$1,060.20	1	833
34	34 ft. 7 ins.	411	1	\$4,583.94	584	\$1,085.28	1	853
35	35 ft. 7 ins.	423	1	\$4,640.94	596	\$1,114.92	1	874
36	36 ft. 7 ins.	435	1	\$4,686.54	606	\$1,145.70	1	892
37	37 ft. 7 ins.	447	1	\$4,883.76	632	\$1,195.86	1	927
38	38 ft. 7 ins.	459	1	\$4,803.96	629	\$1,212.96	1 1/2	931
39	39 ft. 7 ins.	471	1	\$4,986.36	655	\$1,257.42	1 1/2	966
40	40 ft. 7 ins.	483	1 1/2	\$5,043.36	668	\$1,285.92	1 1/2	987
41	41 ft. 7 ins.	495	1 1/2	\$4,965.84	664	\$1,299.60	1 1/2	991
42	42 ft. 7 ins.	507	1 1/2	\$5,159.64	690	\$1,353.18	1 1/2	1026
43	43 ft. 7 ins.	519	1 1/2	\$5,208.66	700	\$1,383.96	1 1/2	1044
44	44 ft. 7 ins.	531	1 1/2	\$5,264.52	713	\$1,407.90	1 1/2	1065
45	45 ft. 7 ins.	543	1 1/2	\$5,339.76	726	\$1,450.08	1 1/2	1085
46	46 ft. 7 ins.	555	1 1/2	\$5,369.40	736	\$1,469.46	1 1/2	1104
47	47 ft. 7 ins.	567	1 1/2	\$5,564.34	762	\$1,519.62	1 1/2	1138
48	48 ft. 7 ins.	579	1 1/2	\$5,485.68	758	\$1,536.72	1 1/2	1143
49	49 ft. 7 ins.	591	1 1/2	\$5,668.08	785	\$1,581.18	1 1/2	1177
50	50 ft. 7 ins.	603	1 1/2	\$5,725.08	797	\$1,610.82	1 1/2	1198



18" BELT CONVEYOR WITH HOPPER

Price does not include motor	Options:	02805 SCRAPER 18	Belt Scraper	\$212.00
Requires C-face motor		02805 COVER 18	Cover / ft.	\$17.00
		02805 DS18	Discharge spout	\$312.00
		02805 DRIVE HD	HD drive required for 3 hp motor	\$998.00

NOTE:

Estimated capacity (no elevation): 35 Tons per hour @ 60 lbs / bushel
Optional sides available. Addition of sides may change the horsepower requirements.

* Motor sized for incline of 0 degrees.

Length (feet) nominal	Over All	Shaft Centres (Inches)	Motor Hp *	Price Crescent Belt	ESTIMATED WEIGHT (lbs) (no sides)	OPTIONAL SIDES ADD \$	Motor Hp *	ESTIMATED WEIGHT (lbs) (with sides)
6	6 ft. 7 ins.	75	1/2	\$2,816	236	\$174	1/2	277
7	7 ft. 7 ins.	87	1/2	\$3,039	267	\$225	1/2	316
8	8 ft. 7 ins.	99	1/2	\$2,951	261	\$239	1/2	318
9	9 ft. 7 ins.	111	1/2	\$3,138	288	\$285	1/2	354
10	10 ft. 7 ins.	123	1/2	\$3,246	309	\$315	1/2	383
11	11 ft. 7 ins.	135	1/2	\$3,159	303	\$327	1/2	385
12	12 ft. 7 ins.	147	1/2	\$3,362	331	\$382	3/4	421
13	13 ft. 7 ins.	159	3/4	\$3,449	348	\$412	3/4	446
14	14 ft. 7 ins.	171	3/4	\$3,537	365	\$438	3/4	472
15	15 ft. 7 ins.	183	3/4	\$3,620	379	\$478	3/4	494
16	16 ft. 7 ins.	195	3/4	\$3,656	390	\$497	3/4	513
17	17 ft. 7 ins.	207	3/4	\$3,860	418	\$549	3/4	549
18	18 ft. 7 ins.	219	3/4	\$3,789	415	\$564	1	554
19	19 ft. 7 ins.	231	1	\$3,980	442	\$609	1	590
20	20 ft. 7 ins.	243	1	\$4,029	453	\$638	1	609
21	21 ft. 7 ins.	255	1	\$3,998	457	\$651	1	621
22	22 ft. 7 ins.	267	1	\$4,234	488	\$716	1	660
23	23 ft. 7 ins.	279	1	\$4,270	499	\$735	1	679
24	24 ft. 7 ins.	291	1	\$4,338	513	\$762	1 1/2	701
25	25 ft. 7 ins.	303	1 1/2	\$4,388	524	\$791	1 1/2	720
26	26 ft. 7 ins.	315	1 1/2	\$4,441	535	\$821	1 1/2	739
27	27 ft. 7 ins.	327	1 1/2	\$4,715	572	\$886	1 1/2	784
28	28 ft. 7 ins.	339	1 1/2	\$4,628	569	\$889	1 1/2	790
29	29 ft. 7 ins.	351	1 1/2	\$4,848	596	\$953	1 1/2	825
30	30 ft. 7 ins.	363	1 1/2	\$4,869	607	\$962	1 1/2	845
31	31 ft. 7 ins.	375	1 1/2	\$4,799	605	\$975	1 1/2	850
32	32 ft. 7 ins.	387	1 1/2	\$5,019	632	\$1,039	1 1/2	886
33	33 ft. 7 ins.	399	1 1/2	\$5,057	643	\$1,060	1 1/2	905
34	34 ft. 7 ins.	411	1 1/2	\$5,160	664	\$1,085	1 1/2	934
35	35 ft. 7 ins.	423	1 1/2	\$5,226	678	\$1,115	1 1/2	956
36	36 ft. 7 ins.	435	1 1/2	\$5,279	688	\$1,146	2	980
37	37 ft. 7 ins.	447	2	\$5,486	722	\$1,196	2	1016
38	38 ft. 7 ins.	459	2	\$5,414	719	\$1,213	2	1022
39	39 ft. 7 ins.	471	2	\$5,604	747	\$1,257	2	1057
40	40 ft. 7 ins.	483	2	\$5,707	767	\$1,286	2	1086
41	41 ft. 7 ins.	495	2	\$5,636	764	\$1,300	2	1091
42	42 ft. 7 ins.	507	2	\$5,841	792	\$1,353	2	1127
43	43 ft. 7 ins.	519	2	\$5,895	803	\$1,384	2	1146
44	44 ft. 7 ins.	531	2	\$5,962	817	\$1,408	2	1168
45	45 ft. 7 ins.	543	2	\$6,044	831	\$1,450	2	1190
46	46 ft. 7 ins.	555	2	\$6,082	842	\$1,469	2	1210
47	47 ft. 7 ins.	567	2	\$6,324	876	\$1,520	2	1252
48	48 ft. 7 ins.	579	2	\$6,253	873	\$1,537	3	1269
49	49 ft. 7 ins.	591	2	\$6,443	901	\$1,581	3	1305
50	50 ft. 7 ins.	603	3	\$6,509	927	\$1,611	3	1328



24" BELT CONVEYOR WITH HOPPER

Price does not include motor	Options:	02805 SCRAPER 24	Belt Scraper	\$271.00
Requires C-face motor		02805 COVER 24	Cover / ft.	\$21.00
		02805 DS24	Discharge spout	\$360.00
		02805 DRIVE HD	HD drive required for 3 hp motor	\$998.00

NOTE:

Estimated capacity (no elevation): 35 Tons per hour @ 60 lbs / bushel
 Optional sides available. Addition of sides may change the horsepower requirements.

* Motor sized for incline of 0 degrees.

Length (feet) nominal	Over All	Shaft Centres (Inches)	Motor Hp *	Price Crescent Belt	ESTIMATED WEIGHT (lbs) (no sides)	OPTIONAL SIDES ADD \$	Motor Hp *	ESTIMATED WEIGHT (lbs) (with sides)
6	6 ft. 7 ins.	75	1/2	\$3,002	260	\$174	1/2	301
7	7 ft. 7 ins.	87	1/2	\$3,236	293	\$225	3/4	342
8	8 ft. 7 ins.	99	3/4	\$3,158	288	\$239	3/4	345
9	9 ft. 7 ins.	111	3/4	\$3,358	317	\$285	3/4	383
10	10 ft. 7 ins.	123	3/4	\$3,486	342	\$315	3/4	415
11	11 ft. 7 ins.	135	1	\$3,409	336	\$327	1	418
12	12 ft. 7 ins.	147	1	\$3,626	366	\$382	1	456
13	13 ft. 7 ins.	159	1	\$3,728	385	\$412	1	484
14	14 ft. 7 ins.	171	1	\$3,834	406	\$438	1	512
15	15 ft. 7 ins.	183	1 1/2	\$3,930	422	\$478	1 1/2	536
16	16 ft. 7 ins.	195	1 1/2	\$3,977	434	\$497	1 1/2	557
17	17 ft. 7 ins.	207	1 1/2	\$4,196	463	\$549	1 1/2	594
18	18 ft. 7 ins.	219	1 1/2	\$4,136	462	\$564	1 1/2	601
19	19 ft. 7 ins.	231	1 1/2	\$4,340	491	\$609	1 1/2	639
20	20 ft. 7 ins.	243	1 1/2	\$4,402	504	\$638	1 1/2	659
21	21 ft. 7 ins.	255	1 1/2	\$4,386	510	\$651	1 1/2	674
22	22 ft. 7 ins.	267	2	\$4,639	549	\$716	2	721
23	23 ft. 7 ins.	279	2	\$4,687	562	\$735	2	741
24	24 ft. 7 ins.	291	2	\$4,766	577	\$762	2	765
25	25 ft. 7 ins.	303	2	\$4,828	590	\$791	2	786
26	26 ft. 7 ins.	315	2	\$4,892	602	\$821	2	806
27	27 ft. 7 ins.	327	2	\$5,188	643	\$886	2	856
28	28 ft. 7 ins.	339	2	\$5,112	642	\$889	2	862
29	29 ft. 7 ins.	351	2	\$5,347	671	\$953	3	912
30	30 ft. 7 ins.	363	3	\$5,379	696	\$962	3	933
31	31 ft. 7 ins.	375	3	\$5,317	694	\$975	3	940
32	32 ft. 7 ins.	387	3	\$5,552	724	\$1,039	3	977
33	33 ft. 7 ins.	399	3	\$5,601	736	\$1,060	3	998
34	34 ft. 7 ins.	411	3	\$5,725	760	\$1,085	3	1030
35	35 ft. 7 ins.	423	3	\$5,804	776	\$1,115	3	1054
36	36 ft. 7 ins.	435	3	\$5,869	788	\$1,146	3	1074
37	37 ft. 7 ins.	447	3	\$6,088	818	\$1,196	3	1112
38	38 ft. 7 ins.	459	3	\$6,027	816	\$1,213	3	1119
39	39 ft. 7 ins.	471	3	\$6,232	846	\$1,257	3	1156
40	40 ft. 7 ins.	483	3	\$6,354	870	\$1,286	3	1189
41	41 ft. 7 ins.	495	3	\$6,295	868	\$1,300	3	1195
42	42 ft. 7 ins.	507	3	\$6,513	898	\$1,353	3	1233
43	43 ft. 7 ins.	519	3	\$6,579	910	\$1,384	***	1253
44	44 ft. 7 ins.	531	***	***	***	***	***	***
45	45 ft. 7 ins.	543	***	***	***	***	***	***
46	46 ft. 7 ins.	555	***	***	***	***	***	***
47	47 ft. 7 ins.	567	***	***	***	***	***	***
48	48 ft. 7 ins.	579	***	***	***	***	***	***
49	49 ft. 7 ins.	591	***	***	***	***	***	***
50	50 ft. 7 ins.	603	***	***	***	***	***	***



EBERSOL ICE CONVEYOR

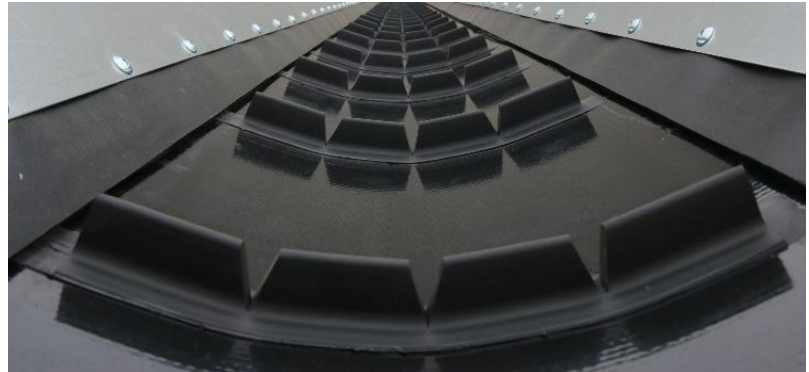
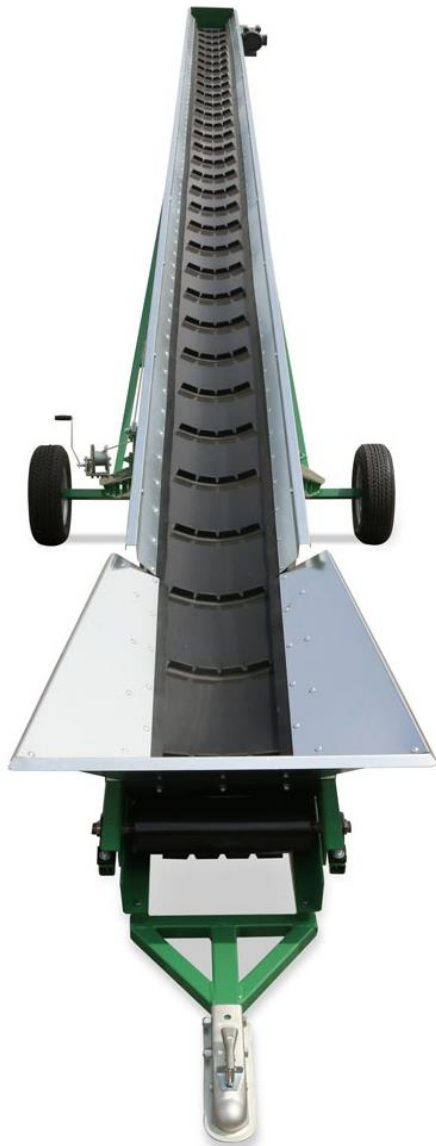

ADD ICE, FIBRES AND POWDERED ADDITIVES TO CONCRETE



PART# 02805 ICE CONVEYOR

Construction Features:

- 16 ga. galvanized construction
- 14" x 32'
- 1" cleated belt with 12" spacing
- 1 1/2 hp electric motor
- Discharge Spout
- Undercarriage
- High capacity to load trucks quickly
- Different hitch types available
(Shown with ball hitch)

100-120 Lehigh Ave. | P.O. BOX 928
Batavia, NY 14020
PHONE: 800-252-1552 | FAX: 888-852-7406



BAUMAN MANUFACTURING

Custom sizes available.
PLEASE CALL FOR PRICING.

100 Stover Drive
Carlisle, PA 17015

PHONE: 800-222-9869 | FAX: 717-249-9384



ELECTRIC MOTORS & HYDRAULIC POWER PACKS

ENERGY SAVER Farm Duty Motors
Single Phase TEFC



TECHTOP HIGH TORQUE MOTOR, 56C ROUND BODY							C-Face
PART #	HP	RPM	Voltage	Frame	Amps	Model Number	List Price
1801 602209-C	1/3	1800	115/230	56C	3.7/1.85	FDR.334C-C-RND-01	\$351.00
1801 602210-C	1/2	1800	115/230	56C	5.2/2.6	FDR.504C-C-RND-01	\$362.00
1801 602211-C	3/4	1800	115/230	56C	7.4/3.7	FDR.754C-C-RND-01	\$396.00
1801 602212-C	1	1800	115/230	56C	9.8/4.9	FDR0004C-C-RND-01	\$450.00
1801 602213-C	1.5	1800	115/230	56C	13.8/6.9	FDR0014C-C-RND-01	\$529.00
1801 607056-145TC	2	1800	115/230	56C	18.4/9.2	FDR0024C-C-RND-01	\$605.00



Standard Features:

- Manual overload
- Class F insulation
- Over 300% starting torque
- Shaft slinger
- Fully gasketed conduit box

HYDRAULIC POWER PACKS (includes oil)			Hydraulic
PART #	HP	Description	List Price
HYD PACK	13	Honda GX -11 gpm pump @ 3400 RPM - pump 4000 psi - 25 gal tank	\$4,722.00

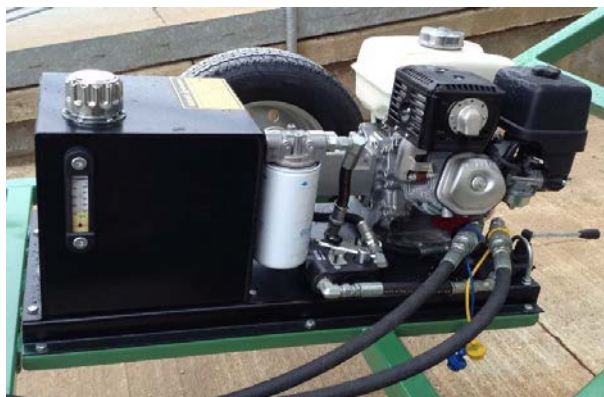

Standard Features:

- Honda engine
- Oil filter spin on
- Temperature gauge
- 1 valve



BAUMAN
MANUFACTURING

TABLE OF CONTENTS

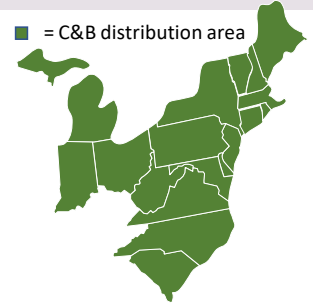

2 HYDRAULIC AUGER DRIVES

LC-SERIES	2
M-SERIES	3
H-SERIES	4
HTLS-SERIES	5
EQUIPMENT MOUNTS	6
HOSE KITS	8
AUGER EXTENSIONS	9
DRIVE ADAPTERS	9

10 AUGER SOLUTIONS

DCA-SERIES	10
SDA-SERIES	11
BHD-SERIES	12
BULLET SERIES	13
SPIRAL SERIES	13
TREE AND SHRUB AUGERS	14
PUFF AUGERS	14
CONSUMABLES	14
PRICING GUIDE	14

15 TM-48 BELLTEC DIGGER

16 LIMITED WARRANTY

HYDRAULIC AUGER DRIVES



HYDRAULIC AUGER DRIVES

Belltec offers a complete four-series lineup of hydraulic auger drives to meet the performance needs of modern equipment operators. Constructed with highest-quality components, expect years of top performance and reliability backed with the best warranty on the market.



LC-SERIES

**HARD-HITTING,
SUB-COMPACT DESIGN**



M-SERIES

**CONDENSED POWER
& PERFORMANCE**



H-SERIES

**PREMIUM FEATURES
& PERFORMANCE**



HTLS-SERIES

**EXTREME TORQUE &
SEVERE CONDITIONS**



LC-150

113130
113130-KIT **\$1910**
\$2655

Dimensions (Drive only)	10 x 10 x 28 in	Gear Train Type	Planetary
Weight Drive/Kit	150 lbs/277 lbs	Min./Max. Flow	6-15 GPM
Output Shaft Size	2-in Hex	Max. Continuous PSI	3000 PSI
Max. Dia. Dirt/Rock	18 in/18 in	Max. Intermittent PSI	3500 PSI

SPEED OUTPUT*	
6 GPM	36 RPM
10 GPM	61 RPM
15 GPM	91 RPM
20 GPM	—

TORQUE OUTPUT*	
2000 PSI	1008 ft. lbs.
2500 PSI	1260 ft. lbs.
3000 PSI	1512 ft. lbs.
3500 PSI	1764 ft. lbs.

- 113130 Includes:**
Auger drive only. Attachment platform & hose kit not included.
- 113130-KIT Includes:**
- LC-150 Hydraulic Auger Drive (113130)
 - Belltec Universal Skid-steer Mount (QT100)
 - 1/2" x 96" Hose Kit with Faster Flat Face Couplings (111385)
- *All values are theoretical. Actual performance may vary.



LC-200

113131
113131-KIT **\$1980**
\$2725

Dimensions (Drive only)	10 x 10 x 28 in	Gear Train Type	Planetary
Weight Drive/Kit	150 lbs/277 lbs	Min./Max. Flow	10-20 GPM
Output Shaft Size	2-in Hex	Max. Continuous PSI	3000 PSI
Max. Dia. Dirt/Rock	30 in/24 in	Max. Intermittent PSI	3500 PSI

SPEED OUTPUT*	
10 GPM	53 RPM
15 GPM	79 RPM
20 GPM	105 RPM
25 GPM	—

TORQUE OUTPUT*	
2000 PSI	1165 ft. lbs.
2500 PSI	1456 ft. lbs.
3000 PSI	1747 ft. lbs.
3500 PSI	2038 ft. lbs.

- 113131 Includes:**
• Auger drive only. Attachment platform & hose kit not included.
- 113131-KIT Includes:**
- LC-200 Hydraulic Auger Drive (113131)
 - Belltec Universal Skid-steer Mount (QT100)
 - 1/2" x 96" Hose Kit with Faster Flat Face Couplings (111385)
- *All values are theoretical. Actual performance may vary.



HYDRAULIC AUGER DRIVES





LC-300

113132 \$2050
113132-KIT \$2795

Dimensions (Drive only) 10 x 10 x 28 in
Weight Drive/Kit 150 lbs/277 lbs
Output Shaft Size 2-in Hex
Max. Dia. Dirt/Rock 36 in/36 in
Gear Train Type Planetary
Min./Max. Flow 15-30 GPM
Max. Continuous PSI 3000 PSI
Max. Intermittent PSI 3500 PSI

SPEED OUTPUT*	
15 GPM	55 RPM
20 GPM	73 RPM
25 GPM	92 RPM
30 GPM	110 RPM

TORQUE OUTPUT*	
2000 PSI	1674 ft. lbs.
2500 PSI	2092 ft. lbs.
3000 PSI	2511 ft. lbs.
3500 PSI	2929 ft. lbs.

113132 Includes:

- Auger drive only. Attachment platform & hose kit not included.

113132-KIT Includes:

- LC-300 Hydraulic Auger Drive (113132)
- Belltec Universal Skid-steer Mount (QT100)
- 1/2" x 96" Hose Kit with Faster Flat Face Couplings (111385)

*All values are theoretical. Actual performance may vary.



LC-350

113133 \$2150
113133-KIT \$2895

Dimensions (Drive only) 10 x 10 x 28 in
Weight Drive/Kit 151 lbs/278 lbs
Output Shaft Size 2-in Hex
Max. Dia. Dirt/Rock 36 in/36 in
Gear Train Type Planetary
Min./Max. Flow 20-35 GPM
Max. Continuous PSI 3000 PSI
Max. Intermittent PSI 3500 PSI

SPEED OUTPUT*	
20 GPM	61 RPM
25 GPM	76 RPM
30 GPM	91 RPM
35 GPM	106 RPM

TORQUE OUTPUT*	
2000 PSI	2016 ft. lbs.
2500 PSI	2520 ft. lbs.
3000 PSI	3025 ft. lbs.
3500 PSI	3529 ft. lbs.

113133 Includes:

- Auger drive only. Attachment platform & hose kit not included.

113133-KIT Includes:

- LC-350 Hydraulic Auger Drive (113133)
- Belltec Universal Skid-steer Mount (QT100)
- 1/2" x 96" Hose Kit with Faster Flat Face Couplings (111385)

*All values are theoretical. Actual performance may vary.



M-200

113028 \$2215
113086 (KIT) \$2960

Dimensions (Drive only) 11 x 11 x 31 in
Weight Drive/Kit 159 lbs/286 lbs
Output Shaft Size 2-in Hex
Max. Dia. Dirt/Rock 30 in/24 in
Gear Train Type Planetary
Min./Max. Flow 10-20 GPM
Max. Continuous PSI 3000 PSI
Max. Intermittent PSI 3500 PSI

SPEED OUTPUT*	
10 GPM	43 RPM
15 GPM	65 RPM
20 GPM	86 RPM
25 GPM	—

TORQUE OUTPUT*	
2000 PSI	1420 ft. lbs.
2500 PSI	1776 ft. lbs.
3000 PSI	2131 ft. lbs.
3500 PSI	2486 ft. lbs.

113028 Includes:

- Auger drive only. Attachment platform & hose kit not included.

113086 Includes:

- M-200 Hydraulic Auger Drive (113028)
- Belltec Universal Skid-steer Mount (QT100)
- 1/2" x 96" Hose Kit with Faster Flat Face Couplings (111385)

*All values are theoretical. Actual performance may vary.



M-300

113029 \$2345
113087 (KIT) \$3090

Dimensions (Drive only) 11 x 11 x 31 in
Weight Drive/Kit 162 lbs/288 lbs
Output Shaft Size 2-in Hex
Max. Dia. Dirt/Rock 36 in/36 in
Gear Train Type Planetary
Min./Max. Flow 15-30 GPM
Max. Continuous PSI 3000 PSI
Max. Intermittent PSI 3500 PSI

SPEED OUTPUT*	
15 GPM	45 RPM
20 GPM	60 RPM
25 GPM	75 RPM
30 GPM	90 RPM

TORQUE OUTPUT*	
2000 PSI	2041 ft. lbs.
2500 PSI	2550 ft. lbs.
3000 PSI	3062 ft. lbs.
3500 PSI	3572 ft. lbs.

113029 Includes:

- Auger drive only. Attachment platform & hose kit not included.

113087 Includes:

- M-300 Hydraulic Auger Drive (113029)
- Belltec Universal Skid-steer Mount (QT100)
- 1/2" x 96" Hose Kit with Faster Flat Face Couplings (111385)

*All values are theoretical. Actual performance may vary.



HYDRAULIC AUGER DRIVES





M-350

113030 \$2565
113088 (KIT) \$3310

Dimensions (Drive only)	11 x 11 x 31 in	Gear Train Type	Planetary
Weight Drive/Kit	192 lbs/319 lbs	Min./Max. Flow	20-35 GPM
Output Shaft Size	2-in Hex	Max. Continuous PSI	3000 PSI
Max. Dia. Dirt/Rock	36 in/36 in	Max. Intermittent PSI	3500 PSI

SPEED OUTPUT*	
20 GPM	50 RPM
25 GPM	62 RPM
30 GPM	75 RPM
35 GPM	87 RPM

TORQUE OUTPUT*	
2000 PSI	2459 ft. lbs.
2500 PSI	3075 ft. lbs.
3000 PSI	3688 ft. lbs.
3500 PSI	4303 ft. lbs.

- 113030 Includes:**
- Auger drive only. Attachment platform & hose kit not included.
- 113088 Includes:**
- M-350 Hydraulic Auger Drive (113030)
 - Belltec Universal Skid-steer Mount (QT100)
 - 1/2" x 96" Hose Kit with Faster Flat Face Couplings (111385)
- *All values are theoretical. Actual performance may vary.



FIELD-SERVICABLE OUTPUT SHAFT



H-Series Hydraulic Auger Drives feature an interchangeable 2-inch hex output shaft (part no. 113300-01) covered by our Belltec Lifetime Part Replacement Program. If this part ever breaks, ship it to us for a free replacement.

HYDRAULIC AUGER DRIVES



H-200

113001 \$2560
113083 (KIT) \$3405

Dimensions (Drive only)	11 x 11 x 35 in	Gear Train Type	Planetary
Weight Drive/Kit	183 lbs/310 lbs	Min./Max. Flow	10-20 GPM
Output Shaft Size	2-in Hex	Max. Continuous PSI	3000 PSI
Max. Dia. Dirt/Rock	30 in/24 in	Max. Intermittent PSI	3500 PSI

SPEED OUTPUT*	
10 GPM	43 RPM
15 GPM	65 RPM
20 GPM	86 RPM
25 GPM	—

TORQUE OUTPUT*	
2000 PSI	1420 ft. lbs.
2500 PSI	1776 ft. lbs.
3000 PSI	2131 ft. lbs.
3500 PSI	2486 ft. lbs.

- 113001 Includes:**
- Auger drive only. Attachment platform & hose kit not included.
- 113083 Includes:**
- H-200 Hydraulic Auger Drive (113001)
 - Belltec Universal Skid-steer Mount (QT100)
 - 1/2" x 96" Hose Kit with Faster Flat Face Couplings (111385)
- *All values are theoretical. Actual performance may vary.



H-300

113014 \$2770
113084 (KIT) \$3515

Dimensions (Drive only)	11 x 11 x 35 in	Gear Train Type	Planetary
Weight Drive/Kit	185 lbs/312 lbs	Min./Max. Flow	15-30 GPM
Output Shaft Size	2-in Hex	Max. Continuous PSI	3000 PSI
Max. Dia. Dirt/Rock	36 in/36 in	Max. Intermittent PSI	3500 PSI

SPEED OUTPUT*	
15 GPM	45 RPM
20 GPM	60 RPM
25 GPM	75 RPM
30 GPM	90 RPM

TORQUE OUTPUT*	
2000 PSI	2041 ft. lbs.
2500 PSI	2550 ft. lbs.
3000 PSI	3062 ft. lbs.
3500 PSI	3572 ft. lbs.

- 113014 Includes:**
- Auger drive only. Attachment platform & hose kit not included.
- 113084 Includes:**
- H-300 Hydraulic Auger Drive (113014)
 - Belltec Universal Skid-steer Mount (QT100)
 - 1/2" x 96" Hose Kit with Faster Flat Face Couplings (111385)
- *All values are theoretical. Actual performance may vary.





H-350

113016 \$2880
113085 (KIT) \$3625

Dimensions (Drive only) 11 x 11 x 35 in
Weight Drive/Kit 216 lbs/343 lbs
Output Shaft Size 2-in Hex
Max. Dia. Dirt/Rock 36 in/36 in
Gear Train Type Planetary
Min./Max. Flow 20-35 GPM
Max. Continuous PSI 3000 PSI
Max. Intermittent PSI 3500 PSI

SPEED OUTPUT*	
20 GPM	50 RPM
25 GPM	62 RPM
30 GPM	75 RPM
35 GPM	87 RPM

TORQUE OUTPUT*	
2000 PSI	2459 ft. lbs.
2500 PSI	3075 ft. lbs.
3000 PSI	3688 ft. lbs.
3500 PSI	4303 ft. lbs.

113016 Includes:

- Auger drive only. Attachment platform & hose kit not included.

113085 Includes:

- H-350 Hydraulic Auger Drive (113016)
- Belltec Universal Skid-steer Mount (QT100)
- 1/2" x 96" Hose Kit with Faster Flat Face Couplings (111385)

*All values are theoretical. Actual performance may vary.



HTLS-6K

113078 \$3845
113092 (KIT) \$4590

Dimensions (Drive only) 11 x 11 x 31 in
Weight Drive/Kit 232 lbs/359 lbs
Output Shaft Size 2-in Hex
Max. Dia. Dirt/Rock 36 in/36 in
Gear Train Type Planetary
Min./Max. Flow 6-15 GPM
Max. Continuous PSI 3000 PSI
Max. Intermittent PSI 3500 PSI

SPEED OUTPUT*	
6 GPM	10 RPM
10 GPM	16 RPM
15 GPM	24 RPM
20 GPM	—

TORQUE OUTPUT*	
2000 PSI	3841 ft. lbs.
2500 PSI	4802 ft. lbs.
3000 PSI	5762 ft. lbs.
3500 PSI	6722 ft. lbs.

113078 Includes:

- Auger drive only. Attachment platform & hose kit not included.

113092 Includes:

- HTLS-6K Hydraulic Auger Drive (113078)
- Belltec Universal Skid-steer Mount (QT100)
- 1/2" x 96" Hose Kit with Faster Flat Face Couplings (111385)

*All values are theoretical. Actual performance may vary.



HTLS-7K

113082 \$4070
113093 (KIT) \$4815

Dimensions (Drive only) 11 x 11 x 31 in
Weight Drive/Kit 236 lbs/363 lbs
Output Shaft Size 2-in Hex
Max. Dia. Dirt/Rock 36 in/36 in
Gear Train Type Planetary
Min./Max. Flow 10-20 GPM
Max. Continuous PSI 3000 PSI
Max. Intermittent PSI 3500 PSI

SPEED OUTPUT*	
10 GPM	14 RPM
15 GPM	21 RPM
20 GPM	28 RPM
25 GPM	—

TORQUE OUTPUT*	
2000 PSI	4438 ft. lbs.
2500 PSI	5548 ft. lbs.
3000 PSI	6657 ft. lbs.
3500 PSI	7767 ft. lbs.

113082 Includes:

- Auger drive only. Attachment platform & hose kit not included.

113093 Includes:

- HTLS-7K Hydraulic Auger Drive (113082)
- Belltec Universal Skid-steer Mount (QT100)
- 1/2" x 96" Hose Kit with Faster Flat Face Couplings (111385)

*All values are theoretical. Actual performance may vary.



HTLS-10K

113077 \$4650
113094 (KIT) \$5395

Dimensions (Drive only) 14 x 14 x 33 in
Weight Drive/Kit 299 lbs/426 lbs
Output Shaft Size 2-1/2 in Hex
Max. Dia. Dirt/Rock 48 in/48 in
Gear Train Type Planetary
Min./Max. Flow 15-30 GPM
Max. Continuous PSI 3000 PSI
Max. Intermittent PSI 3500 PSI

SPEED OUTPUT*	
15 GPM	13 RPM
20 GPM	18 RPM
25 GPM	22 RPM
30 GPM	26 RPM

TORQUE OUTPUT*	
2000 PSI	6981 ft. lbs.
2500 PSI	8726 ft. lbs.
3000 PSI	10471 ft. lbs.
3500 PSI	12216 ft. lbs.

113077 Includes:

- Auger drive only. Attachment platform & hose kit not included.

113094 Includes:

- HTLS-10K Hydraulic Auger Drive (113077)
- Belltec Universal Skid-steer Mount (QT100)
- 1/2" x 96" Hose Kit with Faster Flat Face Couplings (111385)

*All values are theoretical. Actual performance may vary.



HYDRAULIC AUGER DRIVES



EQUIPMENT MOUNTS



TH-100

\$3280

Telescoping Universal Skid-steer Mount

th100

The TH-100 Telescoping Universal Skid-steer Mount quickly interfaces Belltec hydraulic auger drives with equipment that utilizes a universal skid-steer mount. The telescoping boom facilitates the use of longer auger bits or extensions, and it improves the operator's visibility by extending the drive out an additional 65 or 102 inches away from the cab.

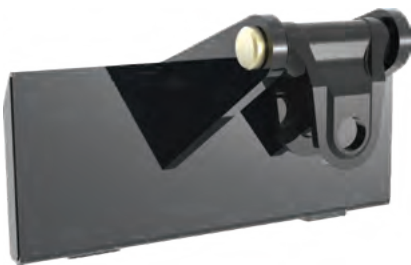

QT-200

\$335

Universal Mini Skid-steer Mount

qt200

The QT-200 Universal Mini Skid-steer Mount quickly interfaces Belltec hydraulic auger drives with equipment that utilizes a universal mini skid-steer mount such as modern mini skid-steer loaders. The QT-200 features a center-mounted swivel and cradle.



QT-100

\$495

Universal Skid-steer Mount

qt100

The QT-100 Universal Skid-steer Mount quickly interfaces Belltec hydraulic auger drives with equipment that utilizes a universal skid-steer mount such as modern skid-steer loaders, track loaders, telehandlers, or tractors. The QT-100 features a center-mounted swivel and cradle.



QT-101

\$495

Offset Universal Skid-steer Mount

qt101

The QT-101 Offset Universal Skid-steer Mount quickly interfaces Belltec hydraulic auger drives with equipment that utilizes a universal skid-steer mount such as modern skid-steer loaders, track loaders, telehandlers, or tractors. The QT-101 features a right-hand mounted swivel and cradle to improve the operator's visibility.



QT-103

\$595

Offset Euro/Global Mount

qt103

The QT-103 Offset Euro/Global Skid-steer Mount quickly interfaces Belltec hydraulic auger drives with equipment that utilizes a euro/global skid-steer mount such as modern skid-steer loaders, track loaders, telehandlers, or tractors. The QT-103 features a right-hand mounted swivel and cradle to improve the operator's visibility.



QT-108

\$550

Offset John Deere Mount

qt108

The QT-108 Offset John Deere Mount quickly interfaces Belltec hydraulic auger drives with John Deere compact track loaders, skid-steer loaders, tractor loaders, and wheel loaders (200 to 500 series models). The QT-108 features a right-hand mounted swivel and cradle to improve the operator's visibility.



QT-1400

\$4410

Ballasted Universal Skid-steer Mount

qt1400

The QT-1400 Ballasted Skid-steer Mount quickly interfaces Belltec hydraulic augers drives with equipment that utilizes a universal skid-steer mount. The QT-1400 is ballasted to 1400 lbs to increase down pressure and dramatically improve drilling efficiency.



QT-1900

\$5845

Ballasted Universal Skid-steer Mount

qt1900

The QT-1900 Ballasted Skid-steer Mount quickly interfaces Belltec hydraulic augers drives with equipment that utilizes a universal skid-steer mount. The QT-1900 is ballasted to 1900 lbs to increase down pressure and dramatically improve drilling efficiency.

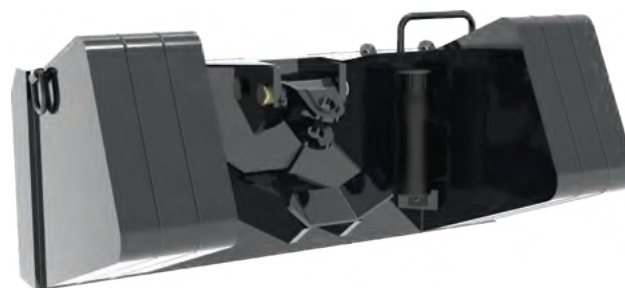

QT-2400

\$7280

Ballasted Universal Skid-steer Mount

qt2400

The QT-2400 Ballasted Universal Skid-steer Mount quickly interfaces Belltec hydraulic augers drives with equipment that utilizes a universal skid-steer mount. The QT-2400 is ballasted to 2400 lbs to increase down pressure and dramatically improve drilling efficiency.



QH-100

\$360

Universal Weld-on Mount

qh100

When welded onto the proper backhoe or excavator quick-attach blank, the QH-100 Universal Weld-on Mount quickly interfaces Belltec hydraulic auger drives with any backhoe or excavator. Professional installation is recommended. Quick-attach blank is not included.



LB-410

\$330

Loader Bucket Mount

lb410

The LB-410 Loader Bucket Mount enables operators to install a Belltec hydraulic auger drive on tractors with a non-detachable loader bucket. The LB-410 welds or bolts directly to the side of the loader bucket to improve the operator's visibility and does not disrupt normal loader bucket operations. Professional installation is recommended.

HYDRAULIC AUGER DRIVES





CUSTOM-BUILT SWIVEL MOUNTS

For Backhoe, Excavators, and Compact Excavators

Custom-built swivel mounts are available for most makes and models. To order a custom-built swivel mount for your equipment, contact a Belltec sales representative, and provide the following information:

Equipment Make and Model, Pin Diameter, Dipper Stick Width

\$495 - Mounts with less than 3in diameter pin

\$715 - Mounts with 3in diameter pin or larger



HOSE KIT

\$180

1/2-in x 96-in Hose Kit with 10MB Hose Fittings

111383

This hydraulic hose kit includes two 1/2-in x 96-in hydraulic hoses fitted with 10MB hose fittings, constructed with seamless heat and oil resistant synthetic rubber tubing, and wrapped with an abrasion and weather-resistant nylon cover. Each hose is reinforced with two braids of high tensile steel wire and has a working pressure of 4000 psi.



HOSE KIT

\$250

1/2-in x 96-in Hose Kit with Flat-Face Couplings

111385

This hydraulic hose kit includes two 1/2-in x 96-in hydraulic hoses fitted with Faster Flat-Face Couplings, constructed with seamless heat and oil resistant synthetic rubber tubing, and wrapped with an abrasion and weather-resistant nylon cover. Each hose is reinforced with two braids of high tensile steel wire and has a working pressure of 4000 psi.



HOSE KIT

\$550

1/2-in x 25-ft Hose Kit for Tractor Loader

111381

This hydraulic hose kit includes two 1/2-in x 25-ft hydraulic hoses fitted with Pioneer style couplings, constructed with seamless heat and oil resistant synthetic rubber tubing, and wrapped with an abrasion and weather-resistant nylon cover. Each hose is reinforced with two braids of high tensile steel wire and has a working pressure of 4000 psi.



COUPLING

\$80

Faster Flat Face Coupling - Male

111387

Faster Flat-Face Couplings enable the operator to connect or disconnect attachment platforms quickly. These couplings offer a real maximum working pressure of 35 MPa and feature zinc-nickel plating. The flat valve shut-off system minimizes the risk of contamination and spillage.



COUPLING

\$115

Faster Flat Face Coupling - Female

111386

Faster Flat-Face couplings enable the operator to connect or disconnect attachment platforms quickly. These couplings offer a real maximum working pressure of 35 MPa and feature zinc-nickel plating. The flat valve shut-off system minimizes the risk of contamination and spillage.



AUGER EXTENSIONS & DRIVE ADAPTORS



2-IN HEX FIXED-LENGTH EXTENSION		
Length	List Price	Part No.
24	\$205	EH200024F
36	\$255	EH200036F
48	\$305	EH200048F
60	\$365	EH200060F
72	\$410	EH200072F



2-IN ROUND FIXED-LENGTH EXTENSION		
Length	List Price	Part No.
24	\$175	ER200024F
36	\$205	ER200036F
48	\$235	ER200048F



2.5-IN ROUND FIXED-LENGTH EXTENSION		
Length	List Price	Part No.
24	\$205	ER250024F
36	\$220	ER250036F
48	\$275	ER250048F
60	\$310	ER250060F
72	\$400	ER250072F



2-IN HEX VARIABLE-LENGTH EXTENSION		
Length	List Price	Part No.
24	\$235	EH200024
36	\$280	EH200036
48	\$335	EH200048
60	\$395	EH200060
72	\$445	EH200072



2-IN ROUND VARIABLE-LENGTH EXTENSION		
Length	List Price	Part No.
24	\$180	ER200024
36	\$205	ER200036
48	\$230	ER200048



2.5-IN ROUND VARIABLE-LENGTH EXTENSION		
Length	List Price	Part No.
24	\$245	ER250024
36	\$285	ER250036
48	\$310	ER250048



2-IN HEX HD TUBULAR EXTENSION		
Length	List Price	Part No.
24	\$355	EHHD200024
36	\$435	EHHD200036
48	\$465	EHHD200048
60	\$500	EHHD200060
72	\$535	EHHD200072
84	\$575	EHHD200084
96	\$650	EHHD200096
120	\$690	EHHD200120
144	\$730	EHHD200144



DRIVE SHAFT ADAPTERS		
List Price	Description	Part No.
\$180	2-in Hex Female to 2-in Round Male	AH200R200
\$205	2-in Hex Female to 2.5-in Round Male	AH200R250
\$215	2-in Hex Female to 2.5-in Round Male with 1/2-in Bolt Hole	AH200R250D
\$295	2-in Hex Female to 2-in Square Male	AH200SQ200
\$475	2.5-in Hex Female to 2-in Hex Male with Shearbolt Protection	AH250H200
\$180	2-in Round Male to 2.5-in Round Male	AR200R250
\$180	2-in Round Female to 2-in Hex Male	AR200H200
\$180	2.5-in Round Female to 2-in Round Male	AR256R200
\$180	2.5-in Round Female to 2-in Hex Male	AR256H200
\$475	2.5-in Hex Female to 2-in Hex Male with welded coupler	AH250H200WC

HYDRAULIC AUGER DRIVES



BELLTEC™ AUGER SOLUTIONS

Belltec offers the most comprehensive line of high-performance augers on the market to maximize performance in any drilling application or environment, and each Belltec auger is standard-built with first-rate components for added quality and value.

- Built with a premium A500 structural steel stem
- Features our patented AugerGuard™ Coupling
- Top-to-bottom heavy-duty flighting
- Boring heads, pilots, and teeth are cast with premium alloy steel and undergo an advanced heat-treatment process.

To find an auger's price and part number:

1. Select the auger drive's output shaft type.

48-INCH OAL SEMI-DOUBLE FLIGHT STANDARD DIRT TEETH				
Diameter	List Price	2-in Round	2.5-in Round	2-in Hex
6	\$270	A06061A	A06061B	A06061C
9	\$375	A09061A	A09061B	A09061C

2. Select bore diameter.

Note: most Belltec auger drives utilize a 2-in hex output shaft.

DCA-SERIES

DCA-Series Auger are a cost-effective solution for drilling in displaceable soils like sand, silt, or clay. DCA augers feature a hardened cast boring to withstand the demands of repeated use.

- Bolt-on tooth design for a secure fit
- Options available in diameters from 4.5-in to 36-in
- Available in 48-in or 54-in overall lengths
- Available in semi-double or double flight designs
- Built with 5/16-in flighting and a 3.5-in diameter pilot

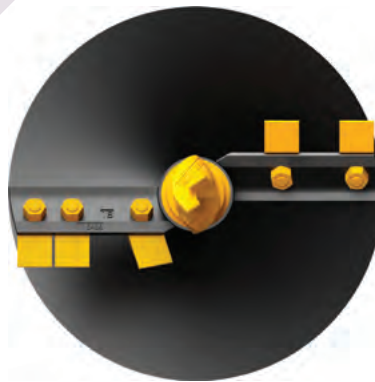

AUGER SOLUTIONS

48-INCH OAL SEMI-DOUBLE FLIGHT STANDARD DIRT TEETH				
Diameter	List Price	2-in Round	2.5-in Round	2-in Hex
6	\$270	A06061A	A06061B	A06061C
9	\$375	A09061A	A09061B	A09061C
12	\$420	A12061A	A12061B	A12061C
15	\$560	A15061A	A15061B	A15061C
18	\$660	A18061A	A18061B	A18061C
24	\$795	A24061A	A24061B	A24061C

48-INCH OAL DOUBLE FLIGHT STANDARD DIRT TEETH				
Diameter	List Price	2-in Round	2.5-in Round	2-in Hex
9	\$390	A09060A	A09060B	A09060C
12	\$445	A12060A	A12060B	A12060C
15	\$605	A15060A	A15060B	A15060C
18	\$715	A18060A	A18060B	A18060C
24	\$880	A24060A	A24060B	A24060C
30	\$1185	A30060A	A30060B	A30060C
36	\$1440	A36060A	A36060B	A36060C

54-INCH OAL SEMI-DOUBLE FLIGHT STANDARD DIRT TEETH				
Diameter	List Price	2-in Round	2.5-in Round	2-in Hex
9	\$425	A09063A	A09063B	A09063C
12	\$475	A12063A	A12063B	A12063C
15	\$660	A15063A	A15063B	A15063C
18	\$775	A18063A	A18063B	A18063C
24	\$950	A24063A	A24063B	A24063C

54-INCH OAL DOUBLE FLIGHT STANDARD DIRT TEETH				
Diameter	List Price	2-in Round	2.5-in Round	2-in Hex
9	\$435	A09062A	A09062B	A09062C
12	\$495	A12062A	A12062B	A12062C
15	\$650	A15062A	A15062B	A15062C
18	\$765	A18062A	A18062B	A18062C
24	\$925	A24062A	A24062B	A24062C
30	\$1235	A30062A	A30062B	A30062C
36	\$1490	A36062A	A36062B	A36062C



SDA-SERIES

SDA-Series Auger are reliable, all-around tools routine drilling in displaceable soils and fractured rock. The improved boring head design and hefty 4.5-inch pilot offer enhanced long-term performance and durability.

- Drive-in tooth design for quick servicing
- Options available in diameters from 4.5 to 36 inches
- Available in 48-in or 54-in overall lengths
- Available in single or double flight designs
- Built with 5/16-in flighting



48-INCH OAL SINGLE FLIGHT STANDARD DIRT TEETH				
Diameter	List Price	2-in Round	2.5-in Round	2-in Hex
4.5	\$285	A04531A	A04531B	A04531C
6	\$385	A06031A	A06031B	A06031C
8	\$425	A08031A	A08031B	A08031C
9	\$430	A09031A	A09031B	A09031C
10	\$485	A10031A	A10031B	A10031C
12	\$505	A12031A	A12031B	A12031C
15	\$655	A15031A	A15031B	A15031C
18	\$795	A18031A	A18031B	A18031C
20	\$850	A20031A	A20031B	A20031C
24	\$950	A24031A	A24031B	A24031C
30	\$1280	A30031A	A30031B	A30031C
36	\$1585	A36031A	A36031B	A36031C

48-INCH OAL SINGLE FLIGHT TUNGSTEN CARBIDE DIRT TEETH				
Diameter	List Price	2-in Round	2.5-in Round	2-in Hex
6	\$485	A06033A	A06033B	A06033C
8	\$535	A08033A	A08033B	A08033C
9	\$540	A09033A	A09033B	A09033C
10	\$610	A10033A	A10033B	A10033C
12	\$635	A12033A	A12033B	A12033C
15	\$820	A15033A	A15033B	A15033C
18	\$995	A18033A	A18033B	A18033C
20	\$1065	A20033A	A20033B	A20033C
24	\$1190	A24033A	A24033B	A24033C
30	\$1600	A30033A	A30033B	A30033C
36	\$1985	A36033A	A36033B	A36033C

48-INCH OAL DOUBLE FLIGHT STANDARD DIRT TEETH				
Diameter	List Price	2-in Round	2.5-in Round	2-in Hex
8	\$560	A08011A	A08011B	A08011C
9	\$565	A09011A	A09011B	A09011C
10	\$600	A10011A	A10011B	A10011C
12	\$620	A12011A	A12011B	A12011C
15	\$760	A15011A	A15011B	A15011C
18	\$930	A18011A	A18011B	A18011C
20	\$1080	A20011A	A20011B	A20011C
24	\$1350	A24011A	A24011B	A24011C
30	\$1665	A30011A	A30011B	A30011C
36	\$1795	A36011A	A36011B	A36011C

48-INCH OAL DOUBLE FLIGHT TUNGSTEN CARBIDE DIRT TEETH				
Diameter	List Price	2-in Round	2.5-in Round	2-in Hex
8	\$700	A08015A	A08015B	A08015C
9	\$710	A09015A	A09015B	A09015C
10	\$750	A10015A	A10015B	A10015C
12	\$775	A12015A	A12015B	A12015C
15	\$950	A15015A	A15015B	A15015C
18	\$1165	A18015A	A18015B	A18015C
20	\$1350	A20015A	A20015B	A20015C
24	\$1690	A24015A	A24015B	A24015C
30	\$2085	A30015A	A30015B	A30015C
36	\$2250	A36015A	A36015B	A36015C

54-INCH OAL SINGLE FLIGHT STANDARD DIRT TEETH				
Diameter	List Price	2-in Round	2.5-in Round	2-in Hex
4.5	\$300	A04530A	A04530B	A04530C
6	\$330	A06030A	A06030B	A06030C
8	\$450	A08030A	A08030B	A08030C
9	\$455	A09030A	A09030B	A09030C
10	\$505	A10030A	A10030B	A10030C
12	\$530	A12030A	A12030B	A12030C

54-INCH OAL SINGLE FLIGHT STANDARD DIRT TEETH				
Diameter	List Price	2-in Round	2.5-in Round	2-in Hex
15	\$675	A15030A	A15030B	A15030C
18	\$825	A18030A	A18030B	A18030C
20	\$895	A20030A	A20030B	A20030C
24	\$975	A24030A	A24030B	A24030C
30	\$1305	A30030A	A30030B	A30030C
36	\$1605	A36030A	A36030B	A36030C

Continued »



BHD-SERIES

BHD-Series Augers free you to focus on the big pictures. The 4.5-in pilot and patented, severe-duty boring head minimize hang-ups in the hardest displaceable soils by powering through gravel, cobble, or fractured rock.

- Bolt-on tooth design for a secure fit
- Options available in diameters from 6 to 48 inches
- Available in 48-in or 54-in overall lengths
- Available in single or double flight designs
- Built with 5/16-in flighting

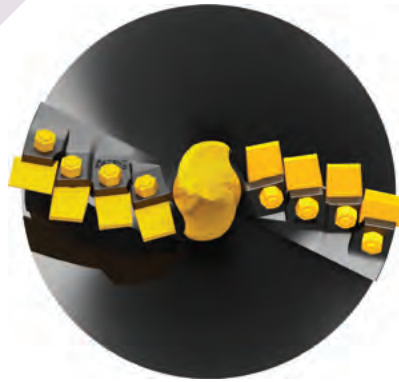

48-INCH OAL SINGLE FLIGHT STANDARD DIRT TEETH				
Diameter	List Price	2-in Round	2.5-in Round	2-in Hex
6	\$440	A06036A	A06036B	A06036C
8	\$475	A08036A	A08036B	A08036C
9	\$485	A09036A	A09036B	A09036C
10	\$515	A10036A	A10036B	A10036C
12	\$580	A12036A	A12036B	A12036C
15	\$660	A15036A	A15036B	A15036C
18	\$880	A18036A	A18036B	A18036C
20	\$1100	A20036A	A20036B	A20036C
24	\$1315	A24036A	A24036B	A24036C
30	\$1660	A30036A	A30036B	A30036C
36	\$1770	A36036A	A36036B	A36036C
42	\$2875	A42036A	A42036B	A42036C
48	\$3095	A48036A	A48036B	A48036C

48-INCH OAL SINGLE FLIGHT TUNGSTEN CARBIDE DIRT TEETH				
Diameter	List Price	2-in Round	2.5-in Round	2-in Hex
6	\$560	A06037A	A06037B	A06037C
8	\$700	A08037A	A08037B	A08037C
9	\$710	A09037A	A09037B	A09037C
10	\$755	A10037A	A10037B	A10037C
12	\$835	A12037A	A12037B	A12037C
15	\$955	A15037A	A15037B	A15037C
18	\$1215	A18037A	A18037B	A18037C
20	\$1630	A20037A	A20037B	A20037C
24	\$1770	A24037A	A24037B	A24037C
30	\$2205	A30037A	A30037B	A30037C
36	\$2370	A36037A	A36037B	A36037C
42	\$3715	A42037A	A42037B	A42037C
48	\$4075	A48037A	A48037B	A48037C

48-INCH OAL DOUBLE FLIGHT STANDARD DIRT TEETH				
Diameter	List Price	2-in Round	2.5-in Round	2-in Hex
8	\$575	A08038A	A08038B	A08038C
9	\$595	A09038A	A09038B	A09038C
10	\$640	A10038A	A10038B	A10038C
12	\$675	A12038A	A12038B	A12038C
15	\$800	A15038A	A15038B	A15038C
18	\$1000	A18038A	A18038B	A18038C
20	\$1290	A20038A	A20038B	A20038C
24	\$1385	A24038A	A24038B	A24038C
30	\$1785	A30038A	A30038B	A30038C
36	\$1995	A36038A	A36038B	A36038C
42	\$3290	A42038A	A42038B	A42038C
48	\$3545	A48038A	A48038B	A48038C

48-INCH OAL DOUBLE FLIGHT TUNGSTEN CARBIDE DIRT TEETH				
Diameter	List Price	2-in Round	2.5-in Round	2-in Hex
8	\$720	A08039A	A08039B	A08039C
9	\$745	A09039A	A09039B	A09039C
10	\$800	A10039A	A10039B	A10039C
12	\$845	A12039A	A12039B	A12039C
15	\$1045	A15039A	A15039B	A15039C
18	\$1280	A18039A	A18039B	A18039C
20	\$1620	A20039A	A20039B	A20039C
24	\$1705	A24039A	A24039B	A24039C
30	\$2275	A30039A	A30039B	A30039C
36	\$2405	A36039A	A36039B	A36039C
42	\$3925	A42039A	A42039B	A42039C
48	\$4300	A48039A	A48039B	A48039C

AUGER SOLUTIONS



BULLET SERIES

Bullet Series Augers are specialized at cutting through tough cobble, boulders, fractured, or solid rock. The advanced, rock-crushing boring head design utilizes C1HD Plus™ Bullet Teeth arranged at optimal cutting angles.

- Outfitted with C1HD Plus™ Bullet Teeth
- Convenient wear indicator strips on boring head*
- Reinforced 3/4-in boring head flight*
- Options available in diameters from 4.5 to 36 inches
- Built with 5/16-in flighting and a 5-in diameter pilot

*Feature may not be available on augers with a 6-in diameter or smaller.



48-INCH OAL SINGLE FLIGHT TUNGSTEN CARBIDE BULLET TEETH				
Diameter	List Price	2-in Round	2.5-in Round	2-in Hex
4.5	\$815	A04518A	A04518B	A04518C
6	\$915	A06018A	A06018B	A06018C
8	\$990	A08005A	A08005B	A08005C
9	\$1005	A09005A	A09005B	A09005C
10	\$1110	A10005A	A10005B	A10005C
12	\$1145	A12005A	A12005B	A12005C
15	\$1780	A15005A	A15005B	A15005C
18	\$1965	A18005A	A18005B	A18005C
24	\$2385	A24005A	A24005B	A24005C
30	\$2645	A30005A	A30005B	A30005C
36	\$3080	A36005A	A36005B	A36005C

48-INCH OAL DOUBLE FLIGHT TUNGSTEN CARBIDE BULLET TEETH				
Diameter	List Price	2-in Round	2.5-in Round	2-in Hex
8	\$1265	A08008A	A08008B	A08008C
9	\$1280	A09008A	A09008B	A09008C
10	\$1360	A10008A	A10008B	A10008C
12	\$1575	A12008A	A12008B	A12008C
15	\$1995	A15008A	A15008B	A15008C
18	\$2110	A18008A	A18008B	A18008C
24	\$2610	A24008A	A24008B	A24008C
30	\$2905	A30008A	A30008B	A30008C
36	\$3315	A36008A	A36008B	A36008C

SPIRAL SERIES

Spiral Series Augers will increase your productivity when you face hard ground. Its earth-grinding conical design and aggressive arrangement of C1HD Plus™ Bullet Teeth will pulverize concrete, fracturable, and solid rock.

- Ultra-performance, hand-laid boring head
- Continuous Stooody 121-G hardfacing
- Continuous 5/8-in thick flighting
- Options available in diameters from 9 to 36 inches
- Built with 5-in diameter pilot

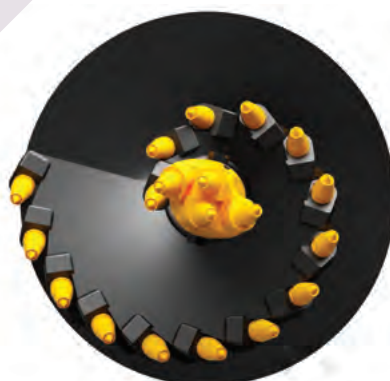

48-INCH OAL SINGLE FLIGHT TUNGSTEN CARBIDE BULLET TEETH				
Diameter	List Price	2-in Round	2.5-in Round	2-in Hex
9	\$1515	A09040A	A09040B	A09040C
12	\$2025	A12040A	A12040B	A12040C
15	\$2525	A15040A	A15040B	A15040C
18	\$2685	A18040A	A18040B	A18040C
24	\$4150	A24040A	A24040B	A24040C
30	\$5470	A30040A	A30040B	A30040C
36	\$6560	A36040A	A36040B	A36040C



MORE DRILLING, LESS MAINTENANCE

Bullet Series and Spiral Series augers now equip the all-new C1HD Plus™ Bullet Teeth, which have more carbide and last longer than ever before.

AUGER SOLUTIONS



SPECIALTY

Tree and Shrub Augers - A variant of DCA-Series Augers, Belltec Tree and Shrub Augers are a cost-effective solution for mechanically digging holes to plant trees or shrubs. Options are available in diameters from 18 to 48 inches.

Belltec Puff Augers - Belltec Puff Augers are specially designed to bore holes into hard ground for installing T-posts. Belltec Puff Augers feature a 1-5/8 inch solid steel shaft and a replaceable 2-in carbide head that efficiently cuts through hard dirt and rock.



48-INCH OAL DOUBLE FLIGHT STANDARD DIRT TEETH				
Diameter	List Price	2-in Round	2.5-in Round	2-in Hex
18	\$690	A09027A	A09027B	A09027C
24	\$715	A12027A	A12027B	A12027C
30	\$1015	A15027A	A15027B	A15027C
36	\$1195	A18027A	A18027B	A18027C
42	\$1870	A20027A	A20027B	A20027C
48	\$2370	A24027A	A24027B	A24027C

48-INCH OAL 2-INCH TUNGSTEN CARBIDE PUFF AUGER				
Diameter	List Price	2-in Round	2.5-in Round	2-in Hex
2	\$440	A02005A	A02005B	A02005C

CONSUMABLES

TEETH		
List Price	Description	Part No.
\$7	Standard Bolt-on Dirt Tooth (DCA, Tree)	112087
\$6	35 Dirt Tooth (SDA, BHD)	112008
\$6	35G Dirt Gauge Tooth (SDA, BHD, SSA)	112026
\$6	5T30 Dirt Spike Tooth (SSA)	112010
\$35	Tungsten Carbide Dirt Tooth (SDA, BHD)	115323
\$24	C1HD Plus™ Teeth (Bullet, Spiral, SRA, RAD)	115185

PILOTS		
List Price	Description	Part No.
\$35	SB35-SQ Pilot (DCA, Tree)	112250
\$55	SB45-SQ Pilot (SDA, SSA)	112252
\$85	FD-475 Pilot (BHD)	115362
\$310	BT-500S Pilot (Bullet, Spiral, RAD)	115052
\$150	CP-16 Pilot (Puff)	115316

PRICING GUIDE

To price a hydraulic drive unit:

- Select a drive unit or kit (pp. 2-5) \$ _____
- Select an equipment mount (pp. 6-8) \$ _____
- Select a hose kit (p. 8) \$ _____
- Select an auger (pp. 10-14) \$ _____
- Select an extension or adapter (p. 9) \$ _____
- Select replacement Teeth an Pilots (p. 14) \$ _____
- Freight \$ _____
- Total \$ _____

To price a TM-48 Belltec Digger:

- Select a TM-48 model (p. 15) \$ _____
- Select an Auger (p. 15) \$ _____
- Select replacement Teeth an Pilots (p. 14) \$ _____
- Freight \$ _____
- Total \$ _____



TM-48 BELLTEC DIGGER

For over thirty years, the legendary TM-48 Belltec Digger has helped tractor owners dig post holes quickly and accurately by transforming their three-point tractors into complete drilling machines. TM-48 models are available for category 1, 2, and 3 hitch systems.



Part No.	Description	Price
TM48 HTL-C1	TM-48 (Cat. 1)	\$6450
TM48 HTL-C2	TM-48 (Cat. 2)	\$6450
TM48 HTL-C3	TM-48 (Cat. 3)	\$6550
TM48 HTL-GRS-C1	TM-48 w/Leveling Cylinders (Cat. 1)	\$7350
TM48 HTL-GRS-C2	TM-48 w/Leveling Cylinders (Cat. 2)	\$7350
TM48 HTL-GRS-C3	TM-48 w/Leveling Cylinders (Cat. 3)	\$7450
100320	Category 2 Hitch Spacer Kit	\$165

SSA-SERIES DIRT AUGERS		
Diameter	List Price	Part No.
6	\$835	A06010
8	\$915	A08010
9	\$940	A09010
10	\$950	A10010
12	\$1085	A12010
15	\$1275	A15010
18	\$1455	A18010

SPIRAL SERIES ROCK AUGERS		
Diameter	List Price	Part No.
9	\$1375	A09040
12	\$1835	A12040
15	\$2290	A15040
18	\$2750	A18040

SRA-SERIES CLUSTER HEADS		
Diameter	List Price	Part No.
6	\$945	A06016
9	\$1095	A09016

RAD-SERIES ROCK AUGERS		
Diameter	List Price	Part No.
8	\$1360	A08006
9	\$1365	A09006
10	\$1375	A10006
12	\$1655	A12006
15	\$1840	A15006
18	\$2205	A18006

2-INCH TUNGSTEN CARBIDE PUFF AUGER		
Diameter	List Price	Part No.
2	\$395	A02005

CONTACT BELLTEC

1-800-242-9410

sales@belltec.net
www.belltec.net



LIMITED WARRANTY

Belltec General Product Limited Warranty

Every Belltec product is warranted to be free of defects in material and workmanship for a period of ONE YEAR from the original date of purchase. Certain products referenced below have more extended warranties. Should a problem develop during the one-year period, return the COMPLETE product, freight prepaid by the user, to Belltec Industries. Belltec Industries reserves the right to inspect all instances of a problem before Belltec Industries replaces the product or performs any repairs or modifications. If inspection shows the problem is caused by defective workmanship or material, Belltec Industries will (at our option) repair, modify, or replace the product without charge.

*See below for limitations and exclusions applicable to Belltec warranties



Belltec Limited 3-Year Warranty, HTLS-Series Hydraulic Auger Drive

Every Belltec HTLS-Series Hydraulic Auger Drive is warranted to be free of defects in material and workmanship for a period of THREE YEARS from the original date of purchase. Should a problem develop during the three-year period, return the COMPLETE HTLS-Series Hydraulic Auger Drive, freight prepaid by the user, to Belltec Industries. Belltec Industries reserves the right to inspect all instances of a problem before Belltec Industries replaces the product or performs any repairs or modifications. If inspection shows the problem is caused by defective workmanship or material, Belltec Industries will (at our option) repair, modify, or replace the HTLS-Series Hydraulic Auger Drive without charge.

*See below for limitations and exclusions applicable to Belltec warranties



Belltec Limited 4-Year Warranty, LC-Series Hydraulic Auger Drive

Every Belltec LC-Series Hydraulic Auger Drive is warranted to be free of defects in material and workmanship for a period of FOUR YEARS from the original date of purchase. Should a problem develop during the four-year period, return the COMPLETE LC-Series Hydraulic Auger Drive, freight prepaid by the user, to Belltec Industries. Belltec Industries reserves the right to inspect all instances of a problem before Belltec Industries replaces the product or performs any repairs or modifications. If inspection shows the problem is caused by defective workmanship or material, Belltec Industries will (at our option) repair, modify, or replace the LC-Series Hydraulic Auger Drive without charge.

*See below for limitations and exclusions applicable to Belltec warranties



Belltec Limited 5-Year Warranty, M-Series Hydraulic Auger Drive

Every Belltec M-Series Hydraulic Auger Drive is warranted to be free of defects in material and workmanship for a period of FIVE YEARS from the original date of purchase. Should a problem develop during the five-year period, return the COMPLETE M-Series Hydraulic Auger Drive, freight prepaid by the user, to Belltec Industries. Belltec Industries reserves the right to inspect all instances of a problem before Belltec Industries replaces the product or performs any repairs or modifications. If inspection shows the problem is caused by defective workmanship or material, Belltec Industries will (at our option) repair, modify, or replace the M-Series Hydraulic Auger Drive without charge.

*See below for limitations and exclusions applicable to Belltec warranties



Belltec Limited 6-Year Warranty, H-Series Hydraulic Auger Drive

Every Belltec H-Series Hydraulic Auger Drive is warranted to be free of defects in material and workmanship for a period of SIX YEARS from the original date of purchase. Should a problem develop during the six-year period, return the COMPLETE H-Series Hydraulic Auger Drive, freight prepaid by the user, to Belltec Industries. Belltec Industries reserves the right to inspect all instances of a problem before Belltec Industries replaces the product or performs any repairs or modifications. If inspection shows the problem is caused by defective workmanship or material, Belltec Industries will (at our option) repair, modify, or replace the H-Series Hydraulic Auger Drive without charge.

*See below for limitations and exclusions applicable to Belltec warranties

Belltec Warranty Limitations and Exclusions

All warranties are voided if:

- Repairs have been made or attempted by others
- Repairs are required because of normal wear and tear
- The tool has been abused, misused, improperly maintained or operated.
- Alterations have been made to the tool.

IN NO EVENT SHALL BELLTEC INDUSTRIES BE LIABLE FOR (A) ANY INDIRECT, INCIDENTAL, PUNITIVE, OR CONSEQUENTIAL DAMAGES ARISING FROM THE SALE OR USE OF THE PRODUCTS SOLD UNDER THESE WARRANTIES, OR (B) ANY AMOUNT IN EXCESS OF THE AMOUNT ACTUALLY PAID TO BELLTEC INDUSTRIES FOR THE PRODUCTS SOLD HEREUNDER. THIS LIMITATION APPLIES BOTH DURING AND AFTER THE TERMS OF THE WARRANTY.

BELLTEC INDUSTRIES DISCLAIMS ALL OTHER WARRANTIES, WHETHER EXPRESSED OR IMPLIED, INCLUDING WITHOUT LIMITATION, THE IMPLIED WARRANTIES OR "MERCHANTABILITY" AND "FITNESS FOR A SPECIFIC PURPOSE." ALL MATERIALS PROVIDED HEREUNDER ARE PROVIDED "AS IS" AND "WITH ALL FAULT."

DISCLAIMER

Belltec Industries, Inc. reserves the right to make changes or improvements on its products without incurring an additional obligation, including any obligation to make corresponding changes or improvements to products previously manufactured or sold. Belltec reserves the right to discontinue products at any time without notice.

All product names, logos, and brands are the property of their respective owners. All company product names and service names used in these materials are for identification purposes only. The use of these names, logos, and brands does not imply endorsement.

All product images displayed in the catalog are the property of Belltec Industries, Inc. and shall not be duplicated or reproduced without the express written consent of Belltec Industries, Inc.

All product images shown are for illustration purposes only and may not be an exact representation of the product.



**Know what's below.
Call 811 before you dig.**

LIMITED WARRANTY









BERLI[®]
MACCHINE AGRICOLE

TAGLIAERBA

GRASS MOWERS
SICHELMULCHER
TONDEUSES
SEGADORAS



-  Tagliaerba per trattori da 15 a 120 HP
-  Grass mowers for tractors from 15 to 120 HP
-  Sichelmulcher für Traktoren von 15 bis 120 PS
-  Tondeuses pour tracteurs de 15 à 120 CV
-  Segadoras para tractores de 15 a 120 CV

HANDY



- Falciatrice spostabile per erba con disco interfilare, per l'impiego agricolo su vigneti e frutteti in genere, da applicare su trattori con potenza compresa tra 40 e 90 HP.
- Tondeuse avec disque entre rangée pivotant, conçue pour broyer l'herbe dans des vignobles et des vergers, à monter sur tracteurs avec puissance entre 40 et 90 CV.
- Displaceable grass mower with between-row rotating disc, suited to work on vineyards and orchards; for tractors from 40 to 90 HP.
- Segadora móvil, para la trituración de hierba y uso agrícola en general en viñedos y frutales para tractores de 40 a 90 CV.
- Verschiebbar Sichelmulcher mit drehbarem Schwenscheibe für Gras auf Wein- und Obstbau. Für Traktoren von 40 und 90 PS.

Mod.	I ↔ I cm	HP												
		Min	Max					A	B	C	D	E	F	
HANDY 125-170	121-170	40	90	55 71+60 04 130+60	2+1	4+2	540 (1000)	131	148	93	30	178	206	390
HANDY 140-190	147-193	40	90	68 72+60 01 142+60 82 80+60	2+1	4+2	540 (1000)	141	152	93	30	199	210	420
HANDY 160-210	166-214	40	90	12 150+60 91 90+60	2+1	4+2	540 (1000)	172	159	93	30	220	217	450
HANDY 180-230	192-234	40	90	01 180+60 90 111+60	3+1	6+2	540 (1000)	198	148	93	30	239	204	490
HANDY 200-250	209-254	40	90	0 201+60 96 138+60	3+1	6+2	540 (1000)	215	123	93	30	260	210	520
HANDY 230-280	239-287	40	90	06 228+60 96 153+60	3+1	6+2	540 (1000)	245	159	93	30	293	217	550
HANDY 250-300	252-302	40	90	06 243+60 135 130+60	3+1	6+2	540 (1000)	258	163	93	30	309	221	580
HANDY 270-320	273-318	40	90	45 220+60 158 152+60	4+1	8+2	540 (1000)	279	152	93	30	324	210	600
HANDY 310-360	314-363	40	90	68 242+60 182 187+60	4+1	8+2	540 (1000)	320	159	93	30	369	217	660
HANDY 360-410	361-415	40	90	92 277+60	4+1	8+2	540 (1000)	368	173	93	30	423	234	750

* Il peso è riferito alla macchina standard (senza accessori) • The weight refers to the machine with standard equipment (without accessories) • Die Gewichtszahl bezieht sich auf die Maschine in Grundausstattung (ohne Sonderausstattung) • Le poids se réfère à la machine standard (sans accessoires) • El peso se refiere al estándar de la máquina (sin accesorios).

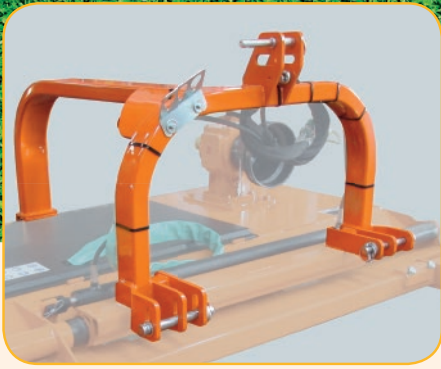

- Attacco a tre punti spostabile idraulicamente, Cat. I-II.
- Displaceable 3-point linkage, Cat. I-II.
- Umkehrbarer Dreipunktbock, Kat. I-II.
- Attelage déportable à 3 points, Cat. I-II.
- Enganche a los 3 puntos, Cat. I-II.



- Ruote fisse frontali, regolabili in altezza.
- Front fixed wheels, height adjustable.
- Laufräder fixe, Höhenverstellung.
- Roues avants fixes, réglables en hauteur.
- Ruedas delanteras fijas regulables en altura.



- Rullo posteriore regolabile in altezza.
- Height adjustable roller.
- Höhenverstellbare Stützwalze.
- Rouleau palpeur réglable en hauteur.
- Rodillo trasero regulable en altura.



- Disco interfilare girevole Ø 60 cm, con rientro a molla e protezione in gomma.
- Between-row rotating disc Ø 60 cm, by means of spring, with rubber protection.
- Drehbare Schwenkscheibe Ø 60 cm mit Federzug.
- Disque entre rangée pivotant Ø 60 cm avec rentrée par ressort et protection en caoutchouc.
- Disco entre-hileras Ø 60 cm con protección de goma y sistema de accionamiento por resorte.



- Coltelli snodati.
- Articulated blades.
- Bewegliche Messer.
- Cousteaux mobiles.
- Cuchillas articuladas.



- Albero cardanico.
- PTO drive shaft.
- Gelenkwelle.
- Arbre cardan.
- Cardan.

FLEXY



Falciatrice a larghezza variabile per erba, di tipo portato per l'impiego agricolo su vigneti e frutteti in genere, da applicare su trattori con potenza compresa tra 40 e 100 HP.



Grass mower with variable working width, suited to work on vineyards and orchards; for tractors from 40 to 100 HP.



Sichelmulcher mit variabler Arbeitsbreite für Gras auf Wein- und Obstbau. Für Traktoren von 40 und 100 PS.









Tondeuse avec largeur de travail variable, conçue pour broyer l'herbedans des vignobles et des vergers, à monter sur tracteurs avec puissance entre 40 et 100 CV.

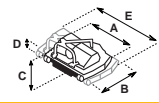

Segadora de corte variable, para la trituración de hierba y uso agrícola en general en viñedos y frutales para tractores de 40 a 100 CV.

* Il peso è riferito alla macchina standard (senza accessori) • The weight refers to the machine with standard equipment (without accessories) • Die Gewichtszugebe bezieht sich auf die Maschine in Grundausstattung (ohne Sonderausstattung) • Le poids se réfère à la machine standard (sans accessoires) • El peso se refiere al estándar de la máquina (sin accesorios).

Mod.												
		Min	Max				n°	n°	PTO	A	B	
FLEXY 110-145	109-141	40	100	2	4	540 (1000)	112	129	107	24	144	430
FLEXY 125-175	126-170	40	100	2	4	540 (1000)	130	139	107	24	174	470
FLEXY 140-195	137-193	40	100	2	4	540 (1000)	141	149	107	24	197	510
FLEXY 160-230	162-223	40	100	2	4	540 (1000)	165	170	101	22	226	580
FLEXY 170-245	173-243	40	100	2	4	540 (1000)	178	165	101	22	248	540
FLEXY 190-260	189-259	40	100	2	4	540 (1000)	192	189	101	22	262	690
FLEXY 220-300	220-299	40	100	2	4	540 (1000)	223	210	101	22	203	790



Per gli accessori vedere pagina nr. 22 - For accessories see at page no. 22 - Für die Zubehör siehe Sie auf Seite Nr. 22
 Pour les accessoires voir page n. 22 - Para los accesorios véase página nr. 22



- Attacco ai tre punti fisso, Cat. I-II.
- Fixed 3-point linkage, Cat. I-II.
- Fester Dreipunktbock, Kat. I-II.
- Attelage fixe à 3 points, Cat. I-II.
- Enganche fijo a los 3 puntos, Cat. I-II.

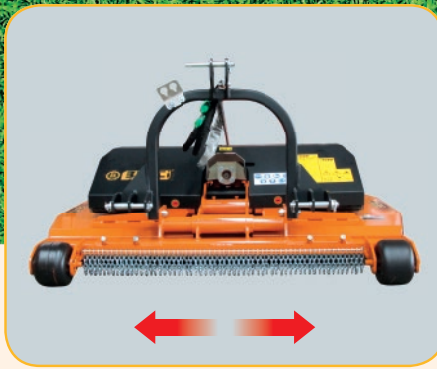

- Larghezza di lavoro variabile.
- Adjustable working width.
- Verstellbare Arbeitsbreite.
- Largeur de travail réglable.
- Anchura de trabajo regulable.

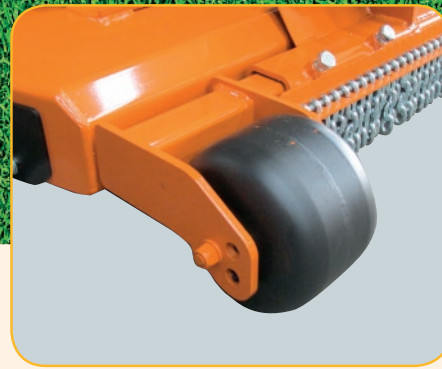

- Ruote frontali, regolabili in altezza e larghezza*
- Front wheels, height and width adjustable*
- Laufräder, Höhen- und Breitenverstellung*
- Roues avant, réglables en hauteur et largeur*
- Ruedas delanteras regulables en altura y anchura*
*(no 110-145 / 170-245).

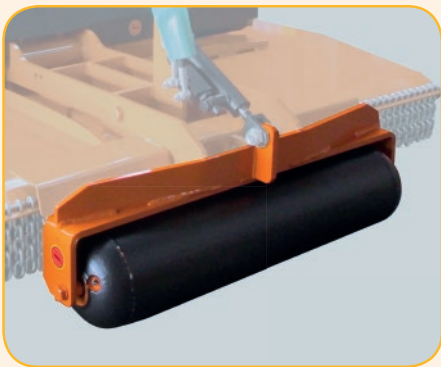

- Rullo posteriore regolabile in altezza.
- Height adjustable roller.
- Höhenverstellbare Stützwalze.
- Rouleau palpeur réglable en hauteur.
- Rodillo trasero regulable en altura.



- Sportelli laterali per scarico dell'erba (>125)*.
- Side chutes for grass discharge (>125)*.
- Grasauswurfklappen beidseitig (>125)*.
- Ailettes pour déchargement latéral de l'herbe (>125)*.
- Rampas laterales de descarga de la hierba (>125)*.
*(no 170-245)

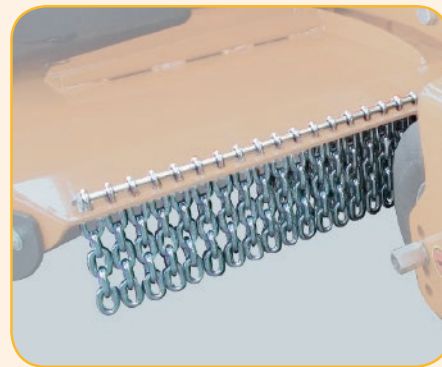

- Protezioni in catena frontali e posteriori.
- Chain guards, front and rear.
- Kettenschützen vorne und hinten.
- Chaînes de protections avants et arrière.
- Protección en cadenas delanteras y traseras.



- Coltelli snodati.
- Articulated blades.
- Bewegliche Messer.
- Couteaux mobiles.
- Cuchillas articuladas.





- Albero cardanico con frizione e ruota libera*.
- PTO drive shaft with clutch and free wheel*.
- Gelenkwelle mit Kupplung und Freilauf*.
- Arbre cardan avec friction et roue libre*.
- Cardan con embrague y rueda libre*.
- * (Mod. 110-145 solo con ruota libera / only with free wheel
nur mit Freilauf / seulement avec roue libre / solo con rueda libre)

FLEXY/T



- 







Falciatrice automatica a larghezza variabile per erba, di tipo portato per l'impiego agricolo su vigneti e frutteti in genere, da applicare su trattori con potenza compresa tra 40 e 100 HP.
- 

Tondeuse avec largeur de travail variable automatiquement, conçue pour broyer l'herbedans des vignobles et des vergers, à monter sur tracteurs avec puissance entre 40 et 100 CV.
- 

Grass mower with variable working width (automatic device), suited to work on vineyards and orchards. for tractors from 40 to 100 HP.
- 

Segadora automática de corte variable para el trabajo en viñedos y explotaciones hortofrutícolas. Para tractores de 40 a 100 C.V. de potencia.
- 

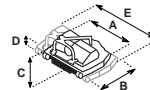
Sichelmulcher mit variabler Arbeitsbreite (Automatisch Taster-Vorrichtung) für Gras auf Wein- und Obstbau. Für Traktoren von 40 und 100 PS.

Mod.																	
		HP	HP				cm	Min	Max	n°	n°		PTO	A	B	C	D
FLEXY 110-145																	
FLEXY 125-175																	
FLEXY 140-195																	
FLEXY 160-230																	
FLEXY 170-245																	
FLEXY 190-260																	
FLEXY 220-300																	



Per gli accessori vedere pagina nr. 22 - For accessories see at page no. 22 - Für die Zubehör siehe Sie auf Seite Nr. 22
 Pour les accessoires voir page n. 22 - Para los accesorios véase página nr. 22

* Il peso è riferito alla macchina standard (senza accessori) • The weight refers to the machine with standard equipment (without accessories) • Die Gewichtszahl bezieht sich auf die Maschine in Grundausstattung (ohne Sonderausstattung) • Le poids se réfère à la machine standard (sans accessoires) • El peso se refiere al estándar de la máquina (sin accesorios).

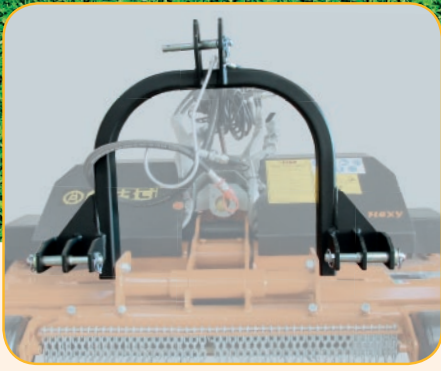

- Attacco ai tre punti fisso, Cat. I-II.
- Fixed 3-point linkage, Cat. I-II.
- Fester Dreipunktbock, Kat. I-II.
- Attelage fixe à 3 points, Cat. I-II.
- Enganche fijo a los 3 puntos, Cat. I-II.

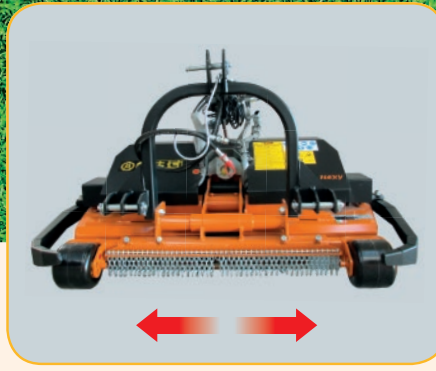

- Larghezza di lavoro variabile.
- Adjustable working width.
- Verstellbare Arbeitsbreite.
- Largeur de travail réglable.
- Anchura de trabajo regulable.



- Tastatori idraulici bilaterali.
- Hydraulic automatic precision sensors both side.
- Hydraulische Feintastautomatik beidseitig.
- Tâteurs hydrauliques bilatérales.
- Palpador hidráulico a ambos lados.

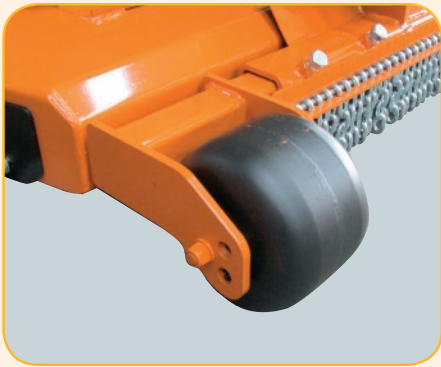

- Ruote frontali, regolabili in altezza e larghezza*.
- Front wheels, height and width adjustable*.
- Laufräder, Höhen- und Breitenverstellung*.
- Roues avants, réglables en hauteur et largeur*.
- Ruedas delanteras regulables en altura y anchura*.

*(no 110-145 / 170-245)

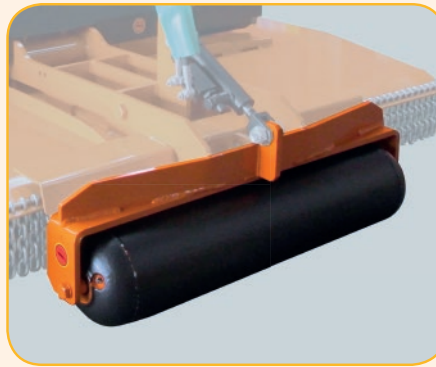

- Rullo posteriore regolabile in altezza.
- Height adjustable roller.
- Höhenverstellbare Stützwalze.
- Rouleau palpeur réglable en hauteur.
- Rodillo trasero regulable en altura.



- Sportelli laterali per scarico dell'erba (>125)*.
- Side chutes for grass discharge (>125)*.
- Grasauswurfklappen beidseitig (>125)*.
- Ailettes pour déchargement latéral de l'herbe (>125)*.
- Rampas laterales de descarga de la hierba (>125)*.

*(no 170-245).



- Protezioni in catena frontali e posteriori.
- Chain guards, front and rear.
- Kettenschützen vorne und hinten.
- Chaînes de protections avants et arrière.
- Protección en cadenas delanteras y traseras.



- Coltelli snodati.
- Articulated blades.
- Bewegliche Messer.
- Couteaux mobiles.
- Cuchillas articuladas.



- Albero cardanico con frizione e ruota libera*.
- PTO drive shaft with clutch and free wheel*.
- Gelenkwelle mit Kupplung und Freilauf*.
- Arbre cardan avec friction et roue libre*.
- Cardan con embrague y rueda libre*.

*(Mod. 110-145 solo con ruota libera only with free wheel / nur mit Freilauf seulement avec roue libre / solo con rueda libre)

VARY/W



- Falciatrice a larghezza variabile per erba, di tipo portato per l'impiego agricolo su vigneti e frutteti in genere, da applicare su trattori con potenza compresa tra 30 e 120 HP.
- Tondeuse avec largeur de travail variable pour broyer l'herbe dans des vignobles et des vergers, à monter sur tracteurs avec puissance entre 30 et 120 CV.
- Grass mower of variable width, suited to work on vineyards and orchards; for tractors from 30 to 120 HP.
- Segadora automática de corte variable para la hierba y el trabajo en viñedos y explotaciones hortofrutícolas en general. Para tractores de 30 a 120 C.V. de potencia.
- Sichelmulcher mit variabler Arbeitsbreite für Gras auf Wein- und Obstbau. Für Traktoren von 30 und 120 PS.

* Il peso è riferito alla macchina standard (senza accessori) • The weight refers to the machine with standard equipment (without accessories) • Die Gewichtszugebe bezieht sich auf die Maschine in Grundausstattung (ohne Sonderausstattung) • El peso se refiere al estándar de la máquina (sin accesorios).

Mod.													
	A	B	Min	Max			n°	n°	PTO	A	B		C
VARY/W 110-190 Ø 45	116	190	30	80	4	8	540 (1000)	121	162	94	25	195	380
VARY/W 120-200 Ø 45	121	202	30	80	4	8	540 (1000)	126	144	94	25	207	430
VARY/W 130-210 Ø 45	130	213	30	80	4	8	540 (1000)	135	149	94	25	218	490
VARY/W 140-220 Ø 45	138	223	30	80	4	8	540 (1000)	143	154	94	25	228	530
VARY/W 140-245 Ø 60	155	253	30	80	4	8	540 (1000)	164	173	94	25	262	540
VARY/W 160-265 Ø 60	159	266	30	80	4	8	540 (1000)	165	178	94	25	275	560
VARY/W 180-285 Ø 60	176	286	40	80	4	8	540 (1000)	183	185	94	25	294	590
VARY/W 200-305 Ø 60	200	307	50	80	4	8	540 (1000)	204	196	94	25	315	630
VARY/W 220-325 Ø 60	217	326	50	80	4	8	540 (1000)	223	211	94	25	335	670
VARY/W 240-345 Ø 60	239	347	60	120	4	8	540 (1000)	245	221	94	25	356	700

Per gli accessori vedere pagina nr. 22 - For accessories see at page no. 22 - Für die Zubehör siehe Sie auf Seite Nr. 22
 Pour les accessoires voir page n. 22 - Para los accesorios véase página nr. 22





- Attacco ai tre punti fisso, Cat. I-II.
- Fixed 3-point linkage, Cat. I-II.
- Fester Dreipunktbock, Kat. I-II.
- Attelage fixe à 3 points, Cat. I-II.
- Enganche fijo a los 3 puntos, Cat. I-II.



- Ruote frontali, regolabili in altezza e larghezza.
- Front wheels, height and width adjustable.
- Laufräder, Höhen- und Breitenverstellung.
- Roues avants, réglables en hauteur et largeur.
- Ruedas delanteras regulables en altura y anchura.



- Rullo posteriore regolabile in altezza.
- Height adjustable roller.
- Höhenverstellbare Stützwalze.
- Rouleau palpeur réglable en hauteur.
- Rodillo trasero regulable en altura.

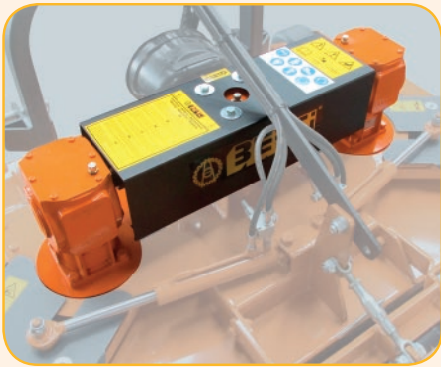

- Trasmissione contro-rotante con tre scatole ingranaggi.
- Counter-rotating transmission, by means of 3 gearboxes.
- Gegenläufiger Getriebeantrieb der Messerrotoren.
- Transmission contre-rotant, à 3 boîtiers.
- Transmisión contra-rotante con 3 cajas de transmisión.

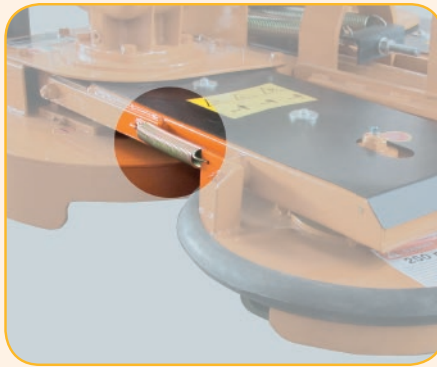

- Trasmissione a cinghie dei dischi laterali con rientro a molla dei dischi.
- Belts transmission on the lateral discs with between-row device by means of springs.
- Schwenkscheiben mit Keilriemenantrieb mit Federzug.
- Transmission par courroies sur les disques latéraux avec rentrée par ressort des disques.
- Transmisión a correas de los discos laterales interfilas con sistema de protección accionado por resortes.



- Apertura/chiusura idraulica dei bracci.
- Hydraulic adjustable arms.
- Hydraulische verstellbare Schwenkarme.
- Ouverture et fermeture hydraulique des bras.
- Anchura/cierre hidráulica de los brazos.



- Coltelli snodati.
- Articulated blades.
- Bewegliche Messer.
- Couteaux mobiles.
- Cuchillas articuladas.



- Albero cardanico con frizione e ruota libera.
- PTO drive shaft with clutch and free wheel.
- Gelenkwelle mit Kupplung und Freilauf.
- Arbre cardan avec friction et roue libre.
- Cardan con embrague y rueda libre.



FRUTTI

OPTIONALS

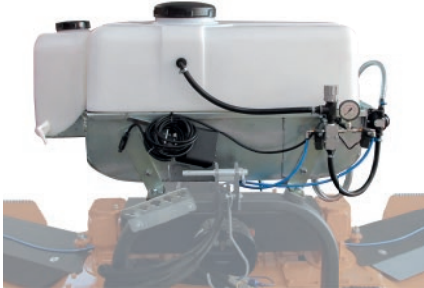

- Kit diserbo con ugelli ed elettrovalvole.
- Herbicide Kit, with nozzles and electro valves.
- Herbizidanlage beidseitig, Spritzdüsen und Elektroventile.
- Jeu désherbage avec tuyères et électrovalves.
- Kit para la aplicación de herbicida..



- Albero cardanico supplementare per attacco frontale e posteriore con ruota libera
- Additional PTO drive shaft for front and rear linkage with free wheel
- Zusätzliche Gelenkwelle für Heck und Frontanbau mit Freilauf
- Arbre cardan supplémentaire pour attelage avant et arrière avec roue libre
- Cardan para TDF delantera con rueda libre.



HANDY

OPTIONALS



- Disco interfilare girevole Ø 80 cm, con rientro a molla e protezione in gomma.
- Between-row rotating disc Ø 80 cm, by means of spring, with rubber protection.
- Drehbare Schwenkscheibe Ø 80 cm mit Federzug.
- Disque entre rangée pivotant Ø 80 cm avec ren-trée par ressort et protection en caoutchouc.
- Disco interfilas Ø 80 cm con retroceso por muelle y protección de goma.

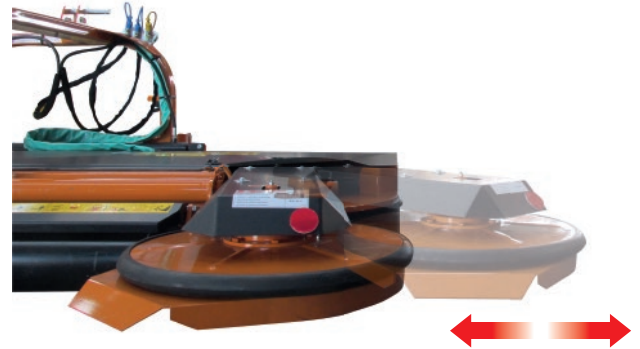

- Cilindro semplice effetto per rientro del braccio.
- Hydraulic cylinder for disc adjusting (only with mech. swing device of disc).
- E.W. Zylinder für Schwenkarmeinzug.
- Vérin hydraulique pour rappel du disque interfilare à rentrée mécanique.
- Cilindro hidráulico para retroceso del disco interfilas con retroceso mecánico.

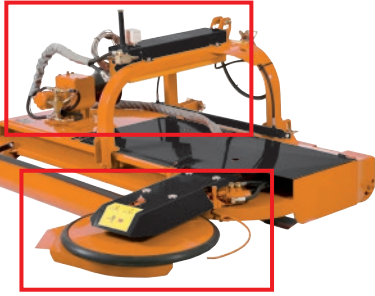

- Sistema interfilare automatico del disco a rientro idraulico, con serbatoio e pompa.
- Automatic Between-Row Swing System of disc with hydraulic swing device, c/w oil tank and pump.
- Hydr. Feintastautomatik einseitig mit hydraulischem Schwenksystem, mit Tank und Pumpe.
- Système entre rangée automatique des disques avec rentrée hydraulique, avec réservoir et pompe.
- Disco entre-hileras automático con sistema de accionamiento hidráulico con bomba y depósito de aceite.



- Regolazione maggiorata dell'altezza di taglio (4-12 cm).
- Height adjustment package roller and wheel (4-12 cm).
- Kit Walzenerhöhung vorne und hinten (4-12 cm)
- Réglage majoré de l'hauteur (4-12 cm.).
- Regulación mejorada para el ajuste de la altura de corte (4-12 cm).



- Protezione a catene anteriori.
- Front chains protector.
- Frontschutz mit Ketten.
- Protections avants avec chaînes
- Protección en cadenas delanteras

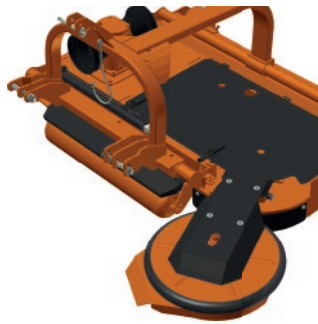

- Versione frontale.
- Front version.
- Front Version.
- Version avant.
- Versión delantera.



- Doppio attacco ai tre punti completo di spostamento idraulico.
- Front & Rear version, c/w hydr. side shift.
- Doppelbock Front - Heck, mit hydr. Seiteneverschiebung.
- Deuxième attelage à 3 points avec déport hydraulique.
- Doble enganche a los tres puntos con desplazamiento hidráulico.

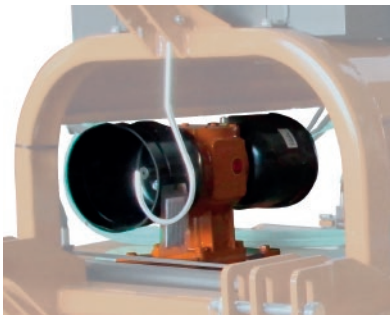

- Scatola ingranaggi con albero passante e doppia ruota libera.
- Through-shaft and double free wheel in the gearbox.
- Getriebe mit Durchtrieb und doppeltem Freilauf.
- Boîtier avec arbre de sortie arrière et double roue libre.
- Caja de transmisión con eje cardan pasante y doble rueda libre.

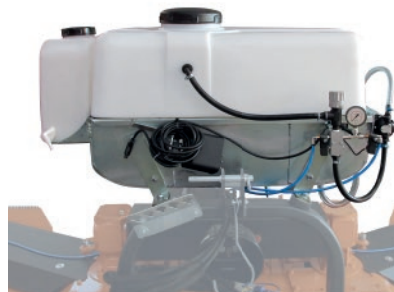

- Kit diserbo con ugelli ed elettrovalvole.
- Herbicide Kit, with nozzles and electro valves.
- Herbizidanlage beidseitig, Spritzdüsen und Elektroventile.
- Jeu désherbage avec tuyères et électrovalves.
- Kit para la aplicación de herbicida..



- Albero cardanico supplementare per attacco frontale e posteriore con ruota libera (solo per doppio attacco)
- Additional PTO drive shaft for front and rear linkage with free wheel (only for double 3-points linkage)
- Zusätzliche Gelenkwelle für Heck und Frontanbau mit Freilauf (nur auf doppeltem Dreipunktbock)
- Arbre cardan supplémentaire pour attelage avant et arrière avec roue libre (seulement pour double attelage à 3 points).
- Cardan para TDF delantera con rueda libre.



HANDY

OPTIONALS



- Ruote in gomma pivotanti anteriori (>310).
- Front pivoting pneumatic wheels (>310).
- Drehbare Gummistützräder vorne (>310).
- Roues frontales pivotantes en caoutchouc (>310).
- Ruedas pivotantes delanteras de goma (>310)



- Ruote in gomma fisse posteriori.
- Two pneumatic fixed rear wheels.
- 2 Fixe Gummiräder hinten.
- Roues postérieures fixes en caoutchouc.
- Ruedas traseras fijas de goma.



- Albero cardanico supplementare per attacco frontale e posteriore con ruota libera (solo per doppio attacco)
- Additional PTO drive shaft for front and rear linkage with free wheel (only for double 3-points linkage)
- Zusätzliche Gelenkwelle für Heck und Frontanbau mit Freilauf (nur auf doppeltem Dreipunktbock)
- Arbre cardan supplémentaire pour attelage avant et arrière avec roue libre (seulement pour double attelage à 3 points).
- Cardan para TDF delantera con rueda libre.



FLEXY - FLEXY/T

OPTIONALS



- Spostamento idraulico.
- Hydraulic side-shift.
- Hydraulische Seitenverschiebung.
- Déport hydraulique.
- Desplazamiento hidráulico.

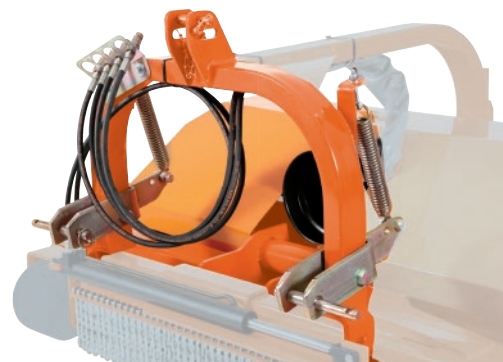

- Ammortizzatore di scarico peso, sul terzo punto (>160-230).
- Relief device for top link (>160-230).
- Entlastungsvorrichtung für Oberlenk (>160-230).
- Système de soutien du troisième point (>160-230).
- Amortiguador de descarga del peso sobre el tercer punto (>160-230).

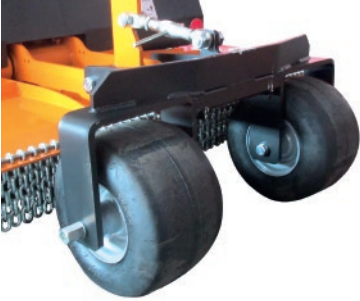

- Ruote in gomma fisse posteriori.
- Fixed rear wheels.
- 2 Fixe Gummiräder hinten.
- Roues postérieures fixes en caoutchouc.
- Ruedas traseras fijas de goma.



- Ruote in gomma pivotanti anteriori con supporto*.
 - Pivoting pneumatic wheels front mounted with support*.
 - Drehbare Gummiräder vorne mit Halterung*.
 - Roues pivotantes avants en caoutchouc avec support*.
 - Ruedas delanteras pivotantes de goma con soporte*.
- *(no 110-145 / 125-175 / 170-245)

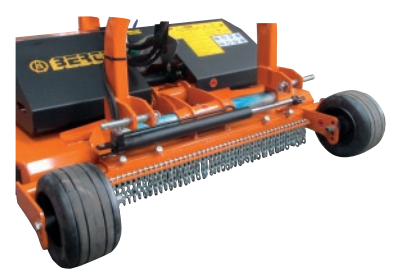

- Ruote in gomma fisse anteriori (>140-195)*.
 - Fixed wheels front mounted (>140-195)*.
 - Fixe Gummiräder vorne (>140-195)*.
 - Roues avants fixes en caoutchouc (>140-195)*.
 - Ruedas delanteras fijas de goma (>140-195).
- * (no 170-245)



- Ruote in gomma pivotanti posteriori con supporto (>160-230).
- Rear pivoting pneumatic wheels with support (>160-230).
- Drehbare Gummiräder hinten mit Halterung (>160-230).
- Roues pivotantes postérieures en caoutchouc avec support (>160-230).
- Ruedas traseras pivotantes de goma con soporte (>160-230).

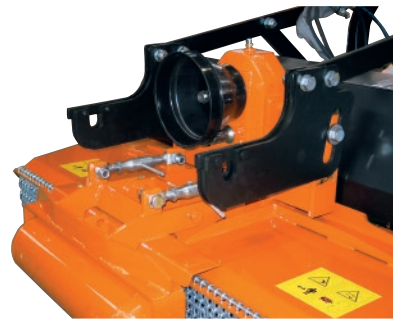

- Supporto attacco atomizzatore con riduttore passante (>140-195).
- Support for spraying equipment mounting with gear drive output shaft (>140-195).
- Support für Sprüheranhängung und Getriebedurchtrieb abschaltbar (>140-195).
- Support pour branchement du pulvérisateur avec boîtier avec arbre de sortie arrière (>140-195).
- Soporte para el enganche del atomizador con eje reductor pasante (>140-195).



- Doppio attacco ai 3 punti con riduttore passante.
- Front & Rear version, c/w through shaft in the gearbox and set of two fixed linkages.
- Front- und Heckanbau Rahmen, und Getriebe mit Durchtrieb und zweiter Dreipunktbock.
- Version avant et arrière, avec boîtier avec arbre de sortie arrière et deuxième attelage à 3 points.
- Doble enganche a los 3 puntos con reductor pasante.



FLEXY - FLEXY/T

OPTIONALS



- Versione frontale.
- Front version.
- Front Version.
- Version avant.
- Versión delantera.

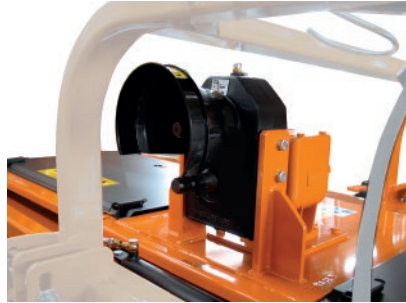

- Riduttore ad assi parallele per inversione della rotazione.
- Front & Rear version, c/w through shaft in the gearbox and set of two fixed linkages.
- Eingangsgetriebe mit zwei Eingängen für Drehrichtungsänderung.
- Boîtier avec double sortie avec rotation inverse.
- Ejes reductores paralelos para la inversión de la rotación.

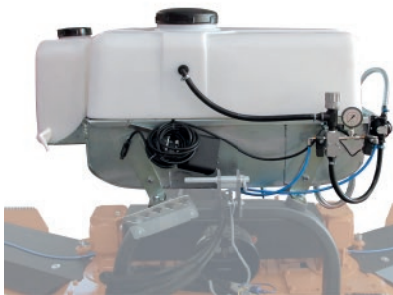

- Kit diserbo con ugelli ed elettrovalvole.
- Herbicide Kit, with nozzles and electro valves.
- Herbizidanlage beidseitig, Spritzdüsen und Elektroventile.
- Jeu désherbage avec tuyères et électrovalves.
- Kit para la aplicación de herbicida..



- Albero cardanico supplementare per attacco frontale e posteriore con frizione e ruota libera (solo per doppio attacco).
- Additional PTO drive shaft for front and rear linkage with clutch and free wheel (only for double 3-points linkage).
- Zusätzliche Gelenkwelle für Heck und Frontanbau mit Kupplung und Freilauf (nur auf doppeltem Dreipunktbock).
- Arbre cardan supplémentaire pour attelage avant et arrière avec friction et roue libre (seulement pour double attelage à 3 points).
- Cardan para TDF delantera con embrague y rueda libre.

VARY/W

OPTIONALS

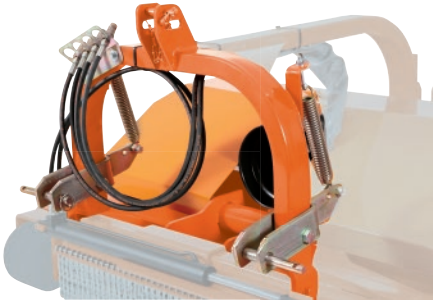

- Dispositivo scarico peso sul terzo punto (>160).
- Relief device for top link (>160)
- Entlastungsvorrichtung für Oberlenk (>160)
- Système de soutien du troisième point (>160)
- Dispositivo de descarga del peso sobre el tercer punto (>160)



- Ruote in gomma anteriori fisse.
- Two fixed wheels front mounted.
- Fixe Gummiräder vorne.
- Roues avants et fixes en caoutchouc.
- Ruedas delanteras fijas de goma.

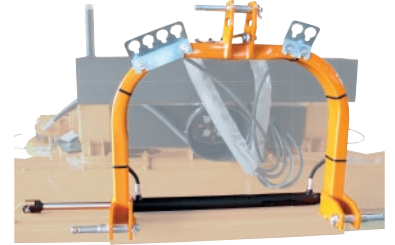

- Spostamento bilaterale idraulico.
- Hydraulic side-shift device.
- Hydraulische Seitenverschiebung.
- Déport hydraulique sur les deux côtés.
- Desplazamiento lateral hidráulico a los dos lados.

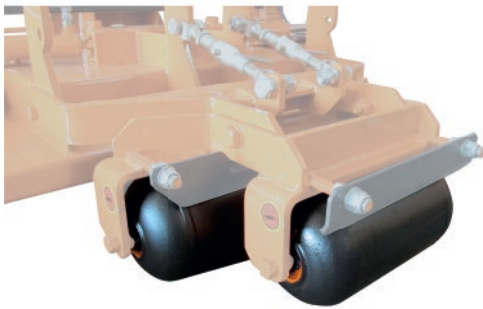

- Doppi rulli posteriori (>140).
- Twin set of rear rollers (soft terrains) (>140).
- Tandemwalze (empf. auf weiche Bodens) (>140).
- Paire de rouleaux arrière (terrains souples) (>140).
- Dobles rodillos traseras (>140).

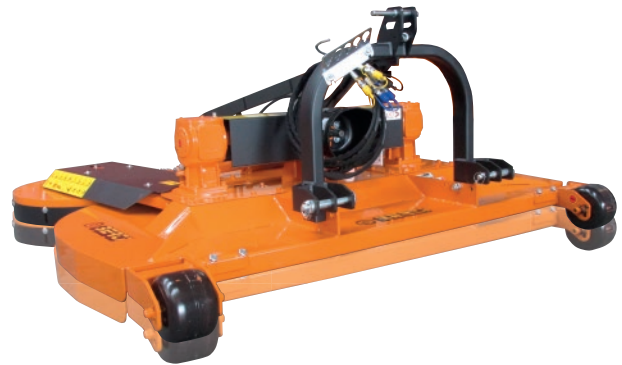

- Regolazione maggiorata dell'altezza di taglio (4-12 cm).
- Height adjustment package roller and wheel (4-12 cm).
- Kit Walzenerhöhung vorne und hinten (4-12 cm).
- Réglage majoré de l'hauteur (4-12 cm).
- Regulación mejorada para el ajuste de la altura de corte (4-12 cm).



- Supporto attacco atomizzatore con riduttore passante (>140).
- Support for spraying equipment mounting with gear drive output shaft (>140).
- Support für Sprüheranhängung und Getriebedurchtrieb abschaltbar (>140).
- Support pour branchement du pulvérisateur avec boîtier avec arbre de sortie arrière (>140).
- Soporte para el enganche del atomizador con eje reductor pasante (>140).



- Versione frontale.
- Front version.
- Front Version.
- Version avant.
- Versión delantera.



VARY/W

OPTIONALS



- Riduttore ad assi parallele per inversione della rotazione.
- Front & Rear version, c/w through shaft in the gearbox and set of two fixed linkages.
- Eingangsgetriebe mit zwei Eingängen für Drehrichtungsänderung.
- Boîtier avec double sortie avec rotation inverse.
- Ejes reductores paralelos para la inversión de la rotación.



- Doppio attacco ai 3 punti con riduttore passante.
- Front & Rear version, c/w through shaft in the gearbox and set of two fixed linkages.
- Front- und Heckanbau Rahmen, und Getriebe mit Durchtrieb und zweiter Dreipunktbock.
- Version avant et arrière, avec boîtier avec arbre de sortie arrière et deuxième attelage à 3 points.
- Doble enganche a los 3 puntos con reductor pasante.

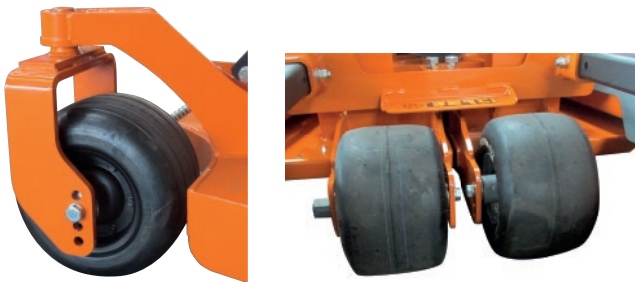

- Ruote in gomma pivotanti anteriori e fisse posteriori (>160).
- Front pivoting rubber wheels and rear fixed rubber wheels (>160).
- Drehbare Gummistützräder vorne und fixe Gummiräder hinten (>160).
- Roues pivotantes frontales et fixes postérieures en caoutchouc(>160).
- Ruedas pivotantes delanteras y traseras fijas de goma (>160).



- Scarico bilaterale del falciato, sul telaio centrale.
- Grass chutes both side, on central body.
- Grasauswurfklappen beidseitig, am haupt Rahmen.
- Ailettes pour déchargement lateral, sur le caisse central.
- Descarga lateral del triturado hacia el cuerpo central de la máquina.

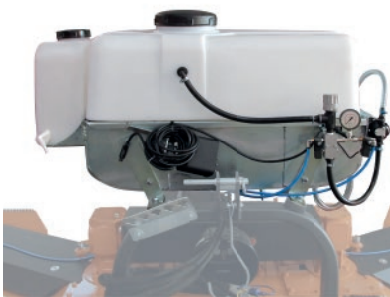

- Kit diserbo con ugelli ed elettrovalvole.
- Herbicide Kit, with nozzles and electro valves.
- Herbizidanlage beidseitig, Spritzdüsen und Elektroventile.
- Jeu désherbage avec tuyères et électrovalves.
- Kit para la aplicación de herbicida..



- Albero cardanico supplementare per attacco frontale e posteriore con frizione e ruota libera (solo per doppio attacco).
- Additional PTO drive shaft for front and rear linkage with clutch and free wheel (only for double 3-points linkage).
- Zusätzliche Gelenkwelle für Heck und Frontanbau mit Kupplung und Freilauf (nur auf doppeltem Dreipunktbock).
- Arbre cardan supplémentaire pour attelage avant et arrière avec friction et roue libre (seulement pour double attelage à 3 points).
- Cardan para TDF delantera con embrague y rueda libre.

VARY

OPTIONALS

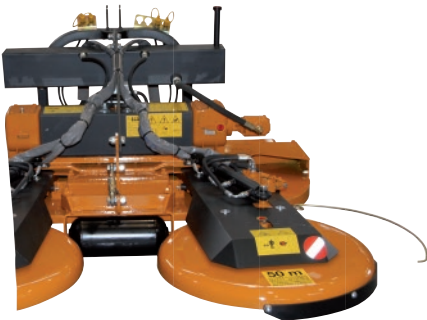
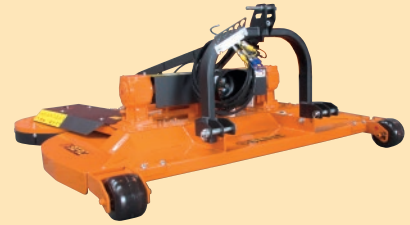

- Sistema interfilar automatico dei dischi, completo di impianto idraulico indipendente
- Automatic Between-Row Swing System of discs, c/w independent hydraulic system and flow controller.
- Hydr. Feintastautomatik beidseitig, hydr. Selbstversorgung, mit Überdrückventil.
- Système entre rangée automatique des disques, avec installation hydraulique indépendante et déviateur de flux.
- Sistema interfilar automático de los discos con instalación hidráulica independiente

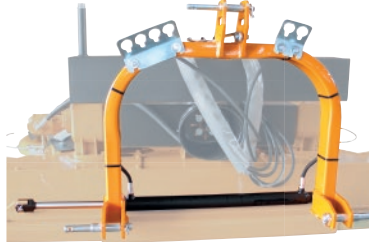

- Spostamento bilaterale idraulico.
- Hydraulic side-shift device.
- Hydraulische Seitenverschiebung.
- Déport hydraulique sur les deux côtés.
- Desplazamiento lateral hidráulico a los dos lados.

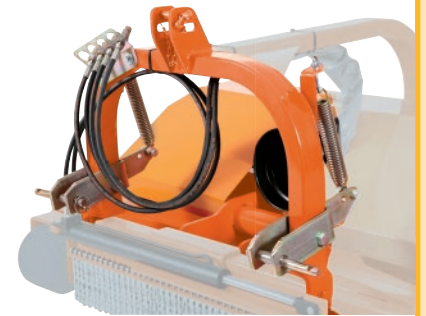

- Dispositivo scarico peso sul terzo punto.
- Relief device for top link
- Entlastungsvorrichtung für Oberlenk
- Système de soutien du troisième point
- Dispositivo de descarga del peso sobre el tercer punto.



- Ruote in gomma anteriori fisse.
- Fixed wheels front mounted.
- Fixe Gummiräder vorne.
- Roues avants et fixes en caoutchouc.
- Ruedas delanteras fijas de goma.



- Ruote in gomma pivotanti anteriori con supporto.
- Pivoting pneumatic wheels front mounted with support.
- Drehbare Gummiräder vorne mit Halterung.
- Roues pivotantes avants en caoutchouc avec support.
- Ruedas delanteras pivotantes de goma con soporte.



- Ruote in gomma posteriori, regolabile in altezza.
- Rear rubber wheels, height adjustable.
- Laufräder aus Gummi höhenverstellbar.
- Roues arrière en caoutchouc, réglable en hauteur.
- Ruedas traseras de goma regulables en altura.

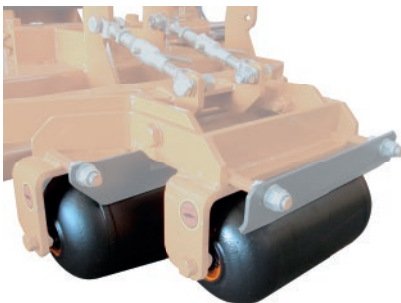

- Doppi rulli posteriori (>140).
- Twin set of rear rollers (soft terrains) (>140).
- Tandemwalze (empf. auf weiche Bodens) (>140).
- Paire de rouleaux arrière (terrains souples) (>140).
- Dobles rodillos traseras (>140).



- Regolazione maggiorata dell'altezza di taglio (4-12 cm).
- Height adjustment package roller and wheel (4-12 cm).
- Kit Walzenerhöhung vorne und hinten (4-12 cm).
- Réglage majoré de l'hauteur (4-12 cm.).
- Regulación mejorada para el ajuste de la altura de corte (4-12 cm).

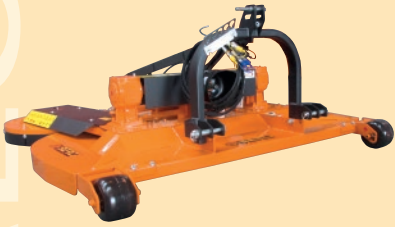

VARY

OPTIONALS



- Supporto attacco atomizzatore con riduttore passante.
- Support for spraying equipment mounting with gear drive output shaft.
- Support für Sprüheranhängung und Getriebedurchtrieb abschaltbar.
- Support pour branchement du pulvérisateur avec boîtier avec arbre de sortie arrière.
- Soporte para el enganche del atomizador con eje reductor pasante.



- Versione frontale.
- Front version.
- Front Version.
- Version avant.
- Versión delantera.



- Riduttore ad assi parallele per inversione della rotazione.
- Front & Rear version, c/w through shaft in the gearbox and set of two fixed linkages.
- Eingangsgetriebe mit zwei Eingängen für Drehrichtungsänderung.
- Boîtier avec double sortie avec rotation inverse.
- Ejes reductores paralelos para la inversión de la rotación.

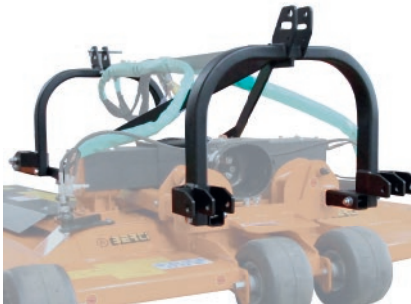

- Doppio attacco ai 3 punti con riduttore passante.
- Front & Rear version, c/w through shaft in the gearbox and set of two fixed linkages.
- Front- und Heckanbau Rahmen, und Getriebe mit Durchtrieb und zweiter Dreipunktbock.
- Version avant et arrière, avec boîtier avec arbre de sortie arrière et deuxième attelage à 3 points.
- Doble enganche a los 3 puntos con reductor pasante.

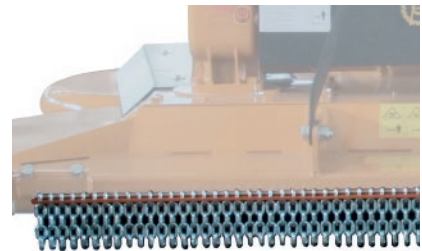

- Protezione a catene anteriori.
- Front chains protector.
- Frontschutz mit Ketten.
- Protections avants avec chaînes
- Protección en cadenas delanteras



- Scarico bilaterale del falciato, sul telaio centrale.
- Grass chutes both side, on central body.
- Grasauswurfklappen beidseitig, am haupt Rahmen.
- Ailettes pour déchargement lateral, sur le caisse central.
- Descarga lateral del triturado hacia el cuerpo central de la máquina.

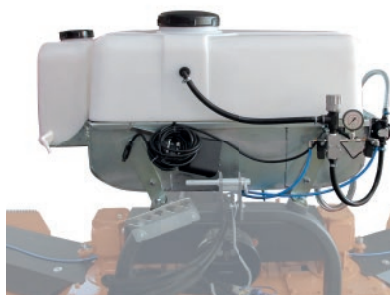

- Kit diserbo con ugelli ed elettrovalvole.
- Herbicide Kit, with nozzles and electro valves.
- Herbizidanlage beidseitig, Spritzdüsen und Elektroventile.
- Jeu désherbage avec tuyères et électrovalves.
- Kit para la aplicación de herbicida..



- Albero cardanico supplementare per attacco frontale e posteriore con frizione e ruota libera (solo per doppio attacco).
- Additional PTO drive shaft for front and rear linkage with clutch and free wheel (only for double 3-points linkage).
- Zusätzliche Gelenkwelle für Heck und Frontanbau mit Kupplung und Freilauf (nur auf doppeltem Dreipunktbock).
- Arbre cardan supplémentaire pour attelage avant et arrière avec friction et roue libre (seulement pour double attelage à 3 points).
- Cardan para TDF delantera con embrague y rueda libre.

VARY/K

OPTIONALS



- Sistema interfilare automatico dei dischi, completo di impianto idraulico indipendente
- Automatic Between-Row Swing System of discs, c/w independent hydraulic system and flow controller.
- Hydr. Feintastautomatik beidseitig, hydr. Selbstversorgung, mit Überdruckventil.
- Système entre rangée automatique des disques, avec installation hydraulique indépendante et déviateur de flux.
- Sistema interfilare automático de los discos con instalación hidráulica independiente

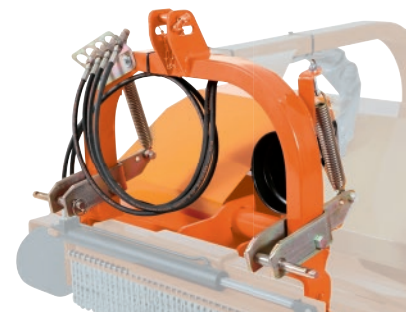

- Dispositivo scarico peso sul terzo punto.
- Relief device for top link
- Entlastungsvorrichtung für Oberlenk
- Système de soutien du troisième point
- Dispositivo de descarga del peso sobre el tercer punto.



- Versione frontale.
- Front version.
- Front Version.
- Version avant.
- Versión delantera.



- Riduttore ad assi parallele per inversione della rotazione.
- Front & Rear version, c/w through shaft in the gearbox and set of two fixed linkages.
- Eingangsgetriebe mit zwei Eingängen für Drehrichtungsänderung.
- Boîtier avec double sortie avec rotation inverse.
- Ejes reductores paralelos para la inversión de la rotación.



- Doppio attacco ai 3 punti con riduttore passante.
- Front & Rear version, c/w through shaft in the gearbox and set of two fixed linkages.
- Front- und Heckanbau Rahmen, und Getriebe mit Durchtrieb und zweiter Dreipunktbock.
- Version avant et arrière, avec boîtier avec arbre de sortie arrière et deuxième attelage à 3 points.
- Doble enganche a los 3 puntos con reductor pasante.

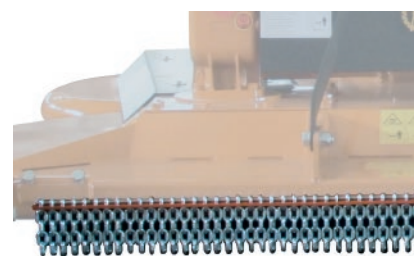

- Protezione a catene anteriori.
- Front chains protector.
- Frontschutz mit Ketten.
- Protections avants avec chaînes
- Protección en cadenas delanteras



VARY/K

OPTIONALS



- Scarico bilaterale del falciato, sul telaio centrale.
- Grass chutes both side, on central body.
- Grasauswurfklappen beidseitig, am haupt Rahmen.
- Ailettes pour déchargement lateral, sur le caisse central.
- Descarga lateral del triturado hacia el cuerpo central de la máquina.

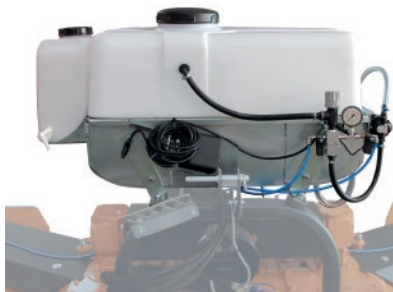

- Kit diserbo con ugelli ed elettrovalvole.
- Herbicide Kit, with nozzles and electro valves.
- Herbizidanlage beidseitig, Spritzdüsen und Elektroventile.
- Jeu désherbage avec tuyères et électrovalves.
- Kit para la aplicación de herbicida..



- Albero cardanico supplementare per attacco frontale e posteriore con frizione e ruota libera (solo per doppio attacco).
- Additional PTO drive shaft for front and rear linkage with clutch and free wheel (only for double 3-points linkage).
- Zusätzliche Gelenkwelle für Heck und Frontanbau mit Kupplung und Freilauf (nur auf doppeltem Dreipunktbock).
- Arbre cardan supplémentaire pour attelage avant et arrière avec friction et roue libre (seulement pour double attelage à 3 points).
- Cardan para TDF delantera con embrague y rueda libre.



TA/PS (M042)

NEW



STRENX®
PERFORMANCE STEEL

M042	Mod.	0010	0001
L180	TA/PS 180		
L200	TA/PS 200		
L220	TA/PS 220	\$20,519	
L250	TA/PS 250		



Trinciatrice professionale multiuso da applicare a trattori con potenza compresa tra 90 e 200 HP. Adatta a lavorare sia posteriormente che lateralmente al trattore. È consigliata per erba, residui vegetali, cespugli e sarmenti fino a \varnothing 10 cm., Ideale per la pulizia di parchi, aree verdi, giardini, bordi di strade, su fossati, argini e terreni inclinati in genere



Heavy-duty offset / in-line mulcher for grass, residue of vegetables, bushes and pruning up to \varnothing 10 cm., suited for tractors from 90 to 200 HP. Ideal machine for contractors who need to clear slopes, ditches, banks of watercourses, road side banks and public green areas in general.



Universalgerät für Heckanbau, für seitliches Mulchen oder hinter dem Schlepper für Gras, Vegetation, Reisig und Äste mit \varnothing 10 cm. für Randstreifen, für Wassergräben und für Böschungen für Traktoren von 90 bis 200 PS.



Broyeur professionnel renforcé multifonctions pour broyer l'herbe, les déchets végétaux, les buissons et les sarments allant de \varnothing 10 cm; adapté pour tracteurs de 90 à 200 CV. Machine idéale pour les personnes qui travaillent pour le compte de tiers et qui doivent nettoyer le rebord des routes, fossés, digues et espaces verts publiques.



Accessori a richiesta

SK01	■ Sistema Antishock BERTI (brevettato).....	€ 790,00
B001	■ Kit slitte antiusura.....	€ 180,00
CE01	■ Contatore elettronico a vibrazione.....	€ 320,00
DR02	■ Distributore a doppio effetto con 2 leve e cavi flessibili.....	€ 660,00
C004	■ Versione sinistra.....	€ 430,00
G002	■ Protezioni frontali in catena con gomma (180-200 - maggiorazione).....	€ 330,00
G003	■ Protezioni frontali in catena con gomma (220-250 - maggiorazione).....	€ 390,00
H003	■ Kit segnaletica stradale con luci (smontato).....	€ 320,00
M037	■ Albero cardanico doppio omocinetico (maggiorazione).....	€ 980,00



Accessories on request

SK01	■ Exclusive BERTI Anti-Shock Device Serie (patented).....	€ 790,00
B001	■ Skids of anti-wearing steel.....	€ 180,00
CE01	■ Hour-meter, vibration activated.....	€ 320,00
DR02	■ Double effect distributor with levers and wire-cables.....	€ 660,00
C004	■ Left hand version.....	€ 430,00
G002	■ Front chains protectors & rubber (180-200 - surcharge).....	€ 330,00
G003	■ Front chains protectors & rubber (220-250 - surcharge).....	€ 390,00
H004	■ Set road-warning panels with lights (spare).....	€ 320,00
M037	■ Double Wide-Angle drive shaft, (surcharge).....	€ 980,00



Sonderausstattung

SK01	■ Anti-Schock System BERTI (patentiert).....	€ 790,00
B001	■ Satz Kufen mit Anti-Verschleißmaterial.....	€ 180,00
CE01	■ Betriebsstunderzähler, Vibration.....	€ 320,00
DR02	■ Bowdenzug-Fernbedienung mit doppelwirkendem Druckverteiler mit 2 Hebeln.....	€ 660,00
C004	■ Linke Version.....	€ 430,00
G002	■ Frontschutze mit Ketten + Gummi (180-200 - Mehrpreis).....	€ 330,00
G003	■ Frontschutze mit Ketten + Gummi (220-250 - Mehrpreis).....	€ 390,00
H004	■ Satz Warntafel mit Beleuchtung (unmontiert).....	€ 320,00
M037	■ Doppel-Weitwinkel Gelenkwelle, (Mehrpreis).....	€ 980,00



Accessoires sur demande

SK01	■ Système antichoc exclusif BERTI (breveté).....	€ 790,00
B001	■ Jeu patins anti-usure.....	€ 180,00
CE01	■ Compteur horaire, à vibration.....	€ 320,00
DR02	■ Distributeur double effet à leviers avec télé-flexibles en cabine.....	€ 660,00
C004	■ Version gauche.....	€ 430,00
G002	■ Protections frontales par chaînes et caoutchouc (180-200 - majoration).....	€ 330,00
G003	■ Protections frontales par chaînes et caoutchouc (220-250 - majoration).....	€ 390,00
H004	■ Kit de signalisation avec système d'éclairage (démonté).....	€ 320,00
M037	■ Arbre cardan double homocinétique (majoration).....	€ 980,00

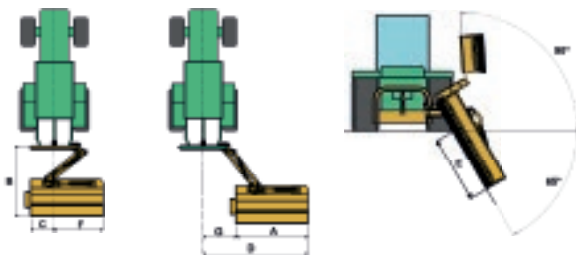

Mod.	A	B	C	D	E	F	G
	cm	cm	cm	cm	cm	cm	cm
TA/PS 180	180	203	17	297	164	163	117
TA/PS 200	200	203	17	317	184	183	117
TA/PS 220	220	203	17	337	204	203	117
TA/PS 250	250	203	17	367	234	233	117

Max 200 HP



Equipaggiamento di serie

- Scatola ingranaggi in posizione esterna al corpo macchina.
- Angolo fiancata destra arrotondato
- Attacco ai tre punti Cat. II con sistema flottante e fermo di sicurezza.
- Tenditore automatico delle cinghie.
- Ruota libera nella scatola ingranaggi con albero 1" 3/4
- Spostamento idraulico con valvola di sicurezza.
- Inclinazione idraulica della macchina con sistema flottante e valvola di blocco.
- Rullo posteriore livellatore autopulente Ø 159 regolabile in altezza.
- Controcoltelli.
- Doppia cassa.
- Scarico posteriore registrabile.
- Albero cardanico a profilo rinforzato.
- Mazze forgiate e bonificate BERTI tipo "A" o kit coltelli "Y".
- PTO 540 g/min.
- Protezioni antinfortunistiche CE.

Il trattore deve essere dotato di almeno n. 2 prese d'olio a doppio effetto



Standard equipment

- Gearbox outside the head body.
- Chamfered profile on the right-end chassis corner.
- 3-point linkage Cat. II with floating system and safety lock.
- Full automatic belts adjuster.
- Free wheel in the gearbox with 1" 3/4 input shaft
- Hydraulic side shift with breakaway valve.
- Hydraulic cylinder for head positioning with floating link and safety valve.
- Height adjustable self-cleaning levelling roller Ø 159.
- Counter-blades.
- Double chassis.
- Adjustable rear discharge.
- Hardened PTO drive shaft.
- Forged and hardened BERTI hammers type "A" or "Y" blades.
- PTO 540 rpm.
- Accident prevention protections according to EC directives.

The tractor has to be equipped with n.2 double effect oil plugs



Grundausrüstung

- Getriebe in äußerer Position.
- Seitliche Abschrägung auf Mulcherrahmen.
- Dreipunktbock Kat. II mit Schwimmstellung-System und Sperrbolzen.
- Automatische Riemenspannung.
- Freilauf im Getriebe mit Welle von 1" 3/4
- Hydraulische Seitenverschiebung mit Anfahrssicherung.
- Hydraulische Neiguvorrichtung mit Schwimmstellung-System und Sicherheitsventilen.
- Höhenverstellbar und selbstreinigende Stützwalze Ø 159.
- Gegenschneiden.
- Doppeltes Gehäuse.
- Verstellbarer Hinterauswurf.
- Verstärkte Gelenkwelle.
- Schlegel BERTI Typ "A" oder "Y"-Messer.
- Getriebe 540 U/min.
- Unfallschutz laut EG-Normen.

Der Traktor muss mit 2 DW Hydraulikanschlüssen ausgestattet sein



Équipement standard

- Boîtier au dehors de la structure de la machine.
- Coin côté droite arrondi.
- Attelage à 3 points, Cat. II avec système flottant et arrêt de sécurité.
- Tendeur automatique des courroies.
- Roue libre dans le boîtier avec arbre d'entrée 1" 3/4
- Déport hydraulique avec soupape de sûreté.
- Inclinaison hydraulique avec système flottant et soupape de sûreté.
- Rouleau palpeur autonettoyant Ø 159.
- Contre couteaux vissés.
- Double caisse.
- Déchargement postérieur réglable.
- Arbre cardan à profil renforcé.
- Marteaux BERTI forgés et trempés type "A" ou couteaux "Y".
- PDF 540 t/min.
- Protections selon normes CE.

Le tracteur doit être équipé avec au moins 2 prises d'huile à double effet

Mod.									
		cm	Min						
TA/PS 180	180	90	200	16	48	5	540	1015	1170
TA/PS 200	200	100	200	18	54	5	540	1060	1215
TA/PS 220	220	100	200	20	60	5	540	1110	1265
TA/PS 250	250	100	200	22	66	5	540	1175	1330

ECOSprint™



HARDOX®
WEAR PLATE



ECOSPRINT 90/140

\$15,985

ECOSPRINT 140/240



Diserbatrice idraulica interfilare a singola testata. Idonea per lo sfalcio e diserbo meccanico dell'erba sottofila su vigneti e frutteti in generale. Equipaggiata con telaio e impianto idraulico indipendenti.



Hydraulic Between-Row Mower with single head, equipped with independent frame and hydraulic system. Ideal for all ecological and mechanical control of the weeds in vineyard and orchard.



Hydraulische Maher mit eigenem Rahmen und hydraulisch Anlage. Zur Spalierpflege im Wein- und Obstbau. Geeignet zu alle Typen von Traktoren.



Machine à désherber hydraulique entre rangées avec simple tête de broyage. Conçue pour couper l'herbe sous les arbres dans des vergers et des vignobles. Disponible système hydraulique autonome et structure indépendante.



Accessori a richiesta

■ Scambiatore di calore (maggiorazione).....	€	660,00
■ Kit 1 cavo comando per azionamento spostamento laterale (maggiorazione).....	€	270,00
■ Kit 1 cavo comando per la regolazione dell'inclinazione di lavoro (maggiorazione).....	€	270,00
■ Kit 1 cavo comando a distanza per la regolazione dell'altezza di lavoro (maggiorazione).....	€	270,00
■ Kit per contropendenze con tubi e innesti rapidi	€	890,00
■ Kit 1 cavo comando per la regolazione della contropendenza (maggiorazione)	€	270,00
■ Comando elettrico Joystick con elettrovalvole (maggiorazione)	€	2.410,00
■ Ruote in gomma (maggiorazione)	€	650,00
■ Albero Cardanico 50/800 N	€	270,00



Accessories on request

■ Oil Cooler (surcharge).....	€	660,00
■ Wire cable kit with lever (in lieu of hydraulic hose) to operate the side-shift (surcharge)	€	270,00
■ Wire cable kit with lever (in lieu of hydraulic hose) for head's tilt adjustment (surcharge)	€	270,00
■ Wire cable kit with lever (in lieu of hydraulic hose) for head's height adjust (surcharge).....	€	270,00
■ Kit for counter-slopes with hoses and quick couplings.....	€	890,00
■ Wire cable kit with lever (in lieu of hydraulic hose) for counter-slopes adjustment (surcharge).....	€	270,00
■ Electric Controls for all functions (surcharge).....	€	2.410,00
■ Rubber Wheels (Surcharge).....	€	650,00
■ PTO drive shaft, type 50/800 N	€	270,00



Sonderausstattung

■ Ölkühler (Mehrpreis).....	€	660,00
■ Kit Bowdenzug + Hebel (Seitenverschiebung) (Mehrpreis)	€	270,00
■ Kit Bowdenzug + Hebel (Neigungsverstellung) (Mehrpreis)	€	270,00
■ Kit Bowdenzug + Hebel (Hohenverstellung) (Mehrpreis)	€	270,00
■ Satz für Gegenhänge	€	890,00
■ Kit Bowdenzug + Hebel (Gegenhängesverstellung - Mehrpreis) ..	€	270,00
■ Elektrische Steuerung mit Joystick Bedienung (alle Funktionen) (Mehrpreis)	€	2.410,00
■ Räder aus Gummi (Mehrpreis).....	€	650,00
■ Gelenkwelle 50/800 N	€	270,00



Accessoires sur demande

■ Refroidisseur d'huile (majoration).....	€	660,00
■ Kit câble commande avec levier (en lieu des tuyaux hydrauliques) pour le déport latéral (majoration).....	€	270,00
■ Kit câble commande avec levier (en lieu des tuyaux hydrauliques) pour le réglage de l'inclinaison de la tête (majoration)	€	270,00
■ Kit câble commande avec levier (en lieu des tuyaux hydrauliques) pour le réglage de la contrepentes (majoration)	€	270,00
■ Kit pour contrepentes avec tuyaux et prises rapides.....	€	890,00
■ Kit câble commande avec levier (en lieu des tuyaux hydrauliques) pour le réglage de la hauteur de la tête (majoration)	€	270,00
■ Commande électrique avec joystick pour toutes les fonctions (les câbles ne sont pas nécessaires) (majoration)	€	2.410,00
■ Jeu de roues pneumatiques (majoration en lieu des roues en fer).....	€	650,00
■ Arbre cardan 50/800 N	€	270,00

Max 100 HP



Equipaggiamento di serie

- Telaio con attacco ai tre punti Cat. I-II.
- Ruote regolabili in altezza.
- Martinetto idraulico per lo spostamento laterale con tubi ed innesti rapidi.
- Martinetto idraulico per la regolazione dell'altezza di lavoro con tubi ed innesti rapidi.
- Martinetto idraulico per la regolazione dell'inclinazione di lavoro e chiusura con tubi ed innesti rapidi.
- Rientro meccanico a molla.
- Testata da cm. 75.
- Centralina oleodinamica autonoma.
- Doppia pompa.
- Serbatoio olio.
- Distributore per innesto/arresto motore con cavo comando a distanza.
- PTO 540 g/min.
- Protezioni antinfortunistiche CE.

Il trattore deve disporre di nr. 3 distributori a doppio effetto.



Standard equipment

- Independent Frame with 3-point linkage Cat I-II.
- Supporting wheels, height adjustable (3 x).
- Hydr. cylinder for side shift.
- Hydr. cylinder for height adjustment of mower head with hoses and quick couplings.
- Hydr. cylinder for tilt adjustment of the mower head with hoses and quick couplings.
- Mechanical spring-device for IN/OUT swing of the mower head with hoses and quick couplings.
- Mower head of 75 cm length.
- Independent hydraulic system.
- Twin-Pump.
- Oil-Tank.
- Distributor for motor on/off, with wire cable.
- PTO 540 U/Min.
- Accident prevention protections according to EC directives.

The tractor has to be equipped with n. 3 double effect distributor.



Grundausrüstung

- Eigene Tragrahmen mit Dreipunkbock Kat. I-II.
- Satz 3x Eisen- Stützräder.
- Hydr. Zylinder für Seitenverschiebung mit Schläuchen und Schnellkupplungen.
- Hydr. Zylinder für Höhenverstellung mit Schläuchen und Schnellkupplungen.
- Hydr. Zylinder für Neigungsverstellung mit Schläuchen und Schnellkupplungen des Mähkopf.
- Feder-Vorrichtung für Schwenkeinzug des Mähkopf.
- Mähkopf von 75 cm.
- Hydraulische Selbstversorgungsanlage.
- Doppel-Pumpe.
- Öl-Tank.
- Steuerung für Motorlauf, mit Bowdenzug.
- Zapfwelle 540 U/Min.
- Unfallschutz laut EG-Normen.

Der Traktor muss mit 3 DW Hydraulikanschlüssen ausgestattet sein.



Equipement standard

- Structure indépendante avec attelage 3 points Cat. I et II.
- Roues de soutien, réglables en hauteur.
- Vérin hydraulique pour déport.
- Vérin hydraulique pour réglage de l'hauteur de la tête avec tuyaux et prises rapides.
- Vérin hydraulique pour réglage de l'inclinaison de la tête avec tuyaux et prises rapides.
- Réglage mécanique par ressort du système d'escamotage de la tête avec tuyaux et prises rapides.
- Tête de broyage de 75 cm.
- Centrale hydraulique indépendante.
- Double pompe.
- Réservoir d'huile.
- Distributeur pour démarrage/arrêt du moteur avec câble.
- PDF 540 t/min.
- Protections selon normes CE.



Le tracteur doit être équipé de 3 prises d'huile à double effet.

Mod.	HP		cm	n°	mm	α°	cm	KG	
	Min	Max						min	max
ECOSPRINT 90-140	40	100	75	16	900 1400	-5° → +45°	10	470	530
ECOSPRINT 140-240	50	100	75	16	1400 2400	-5° → +65°	15	510	570

TA/S (M040)



STRENX®
PERFORMANCE STEEL

M040	Mod.	 0010	 0001
L160	TA/S 160		
L180	TA/S 180		
L200	TA/S 200		\$16,490
L220	TA/S 220		



Trinciatrice compatta multiuso, da applicare a trattori con potenza compresa tra 60 e 110 HP. Adatta a lavorare sia posteriormente che lateralmente al trattore. E' consigliata per erba, residui vegetali, cespugli e sarmenti di Ø 7-8 cm.. Ideale per la pulizia di parchi, aree verdi, giardini, bordi di strade, su fossati, argini e terreni inclinati in genere.



Offset/in-line mulcher for grass, residue of vegetables, bushes and pruning up to Ø 7-8 cm., suited for tractors from 60 to 110 HP. Ideal for clearing green areas, gardens, slopes, ditches, banks of watercourses, road side banks.



Universalgerät für Heckanbau, für seitliches Mulcher oder hinter dem Schlepper für Gras, Vegetation, Reisig und Äste bis Ø 7-8 cm. für Randstreifen, für Wassergräben und für Böschungen, für Traktoren von 60 bis 110 PS.



Broyeur d'accotement multifonctions pour broyer l'herbe, les déchets végétaux, les buissons et les tiges allant jusqu'à Ø 7-8 cm; adapté pour tracteurs de 60 à 110 CV. Il est idéal pour le nettoyage des espaces verts, des jardins, des rebords de route, des fossés, des digues et des terrains inclinés.



Accessori a richiesta

SK01	■ Sistema Antishock BERTI (brevettato).....	€	640,00
B001	■ Kit slitte antiusura.....	€	180,00
CE01	■ Contaore elettronico a vibrazione.....	€	320,00
DR02	■ Distributore a doppio effetto con 2 leve e cavi flessibili.....	€	660,00
G002	■ Protezioni frontali in catena con gomma (160-200 - maggiorazione).....	€	310,00
G003	■ Protezioni frontali in catena con gomma (220 - maggiorazione).....	€	390,00
H003	■ Kit segnaletica stradale con luci (smontato).....	€	320,00
M033	■ Albero cardanico doppio omocinetico (magg.).....	€	880,00



Accessories on request

SK01	■ Exclusive BERTI Anti-Shock Device (patented).....	€	640,00
B001	■ Skids of anti-wearing steel.....	€	180,00
CE01	■ Hour-meter, vibration activated.....	€	320,00
DR02	■ Double effect distributor with levers and wire-cables.....	€	660,00
G002	■ Front chains protectors & rubber (160-200 - surcharge).....	€	310,00
G003	■ Front chains protectors & rubber (220 - surcharge).....	€	390,00
H004	■ Set road-warning panels with lights (spare).....	€	320,00
M033	■ Double Wide-Angle and drive shaft, (surch.).....	€	880,00



Sonderausstattung

SK01	■ Anti-Schock System BERTI (patentiert).....	€	640,00
B001	■ Satz Kufen mit Anti-Verschleißmaterial.....	€	180,00
CE01	■ Betriebsstunderzähler, Vibration.....	€	320,00
DR02	■ Bowdenzug-Fernbedienung mit doppelwirkendem Druckverteiler mit 2 Hebeln.....	€	660,00
G002	■ Frontschutze mit Ketten + Gummi (160-200 - Mehrpreis).....	€	310,00
G003	■ Frontschutze mit Ketten + Gummi (220 - Mehrpreis).....	€	390,00
H004	■ Satz Warntafel mit Beleuchtung (unmontiert).....	€	320,00
M033	■ Doppel-Weitwinkel Gelenkwelle, (Mehrpreis).....	€	880,00



Accessoires sur demande

SK01	■ Système antichoc exclusif BERTI (breveté).....	€	640,00
B001	■ Jeu patins anti-usure.....	€	180,00
CE01	■ Compteur horaire, à vibration.....	€	320,00
DR02	■ Distributeur double effet à leviers avec télé-flexibles en cabine.....	€	660,00
G002	■ Protections frontales par chaînes et caoutchouc (160-200 - majoration).....	€	310,00
G003	■ Protections frontales par chaînes et caoutchouc (220 - majoration).....	€	390,00
H004	■ Kit de signalisation avec système d'éclairage (démonté).....	€	320,00
M033	■ Arbre cardan double homocinétique (majoration).....	€	880,00

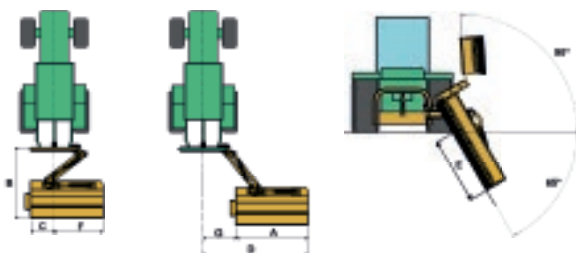

Mod.	A	B	C	D	E	F	G
	cm	cm	cm	cm	cm	cm	cm
TA/S 160	160	170	17	283	151	143	123
TA/S 180	180	170	17	303	174	163	123
TA/S 200	200	170	17	323	194	183	123
TA/S 220	220	170	17	343	214	203	123

Max 110 HP



Equipaggiamento di serie

- Scatola ingranaggi in posizione esterna al corpo macchina.
- Angolo fiancata destra arrotondato.
- Attacco ai tre punti Cat. II con sistema flottante e fermo di sicurezza.
- Scarico posteriore registrabile.
- Ruota libera nella scatola ingranaggi.
- Spostamento idraulico con valvola di sicurezza.
- Doppia cassa.
- Inclinazione idraulica della macchina con sistema flottante e valvola di blocco.
- Rullo posteriore livellatore autopulente Ø 159 regolabile in altezza.
- Tenditore automatico delle cinghie.
- Mazze forgiate e bonificate BERTI tipo "A" o kit coltelli "Y".
- Controcoltelli.
- Albero cardanico a profilo rinforzato.
- PTO 540 g/min.
- Protezioni antinfortunistiche CE.

Il trattore deve essere dotato di almeno n. 2 prese d'olio a doppio effetto



Standard equipment

- Gearbox outside the head body.
- Chamfered profile on the right-end chassis corner.
- 3-point linkage Cat. II with floating system and safety lock.
- Adjustable rear discharge.
- Free wheel in the gearbox.
- Hydraulic side shift with breakaway valve.
- Double chassis.
- Hydraulic cylinder with floating link and safety valve, for head positioning.
- Height adjustable self-cleaning levelling roller Ø 159.
- Full automatic belts adjuster.
- Forged and hardened BERTI hammers type "A" or "Y" blades.
- Counter-blades.
- Hardened PTO drive shaft.
- PTO 540 rpm.
- Accident prevention protections according to EC directives.

The tractor has to be equipped with n.2 double effect oil plugs



Grundausrüstung

- Getriebe in äußerer Position.
- Seitliche Abschrägung auf Mulcherrahmen.
- Dreipunktbock Kat. II mit Schwimmstellung-System und Sperrbolzen.
- Verstellbarer Hinterauswurf.
- Freilauf im Getriebe.
- Hydraulische Seitenverschiebung mit Anfahrtsicherung.
- Doppeltes Gehäuse.
- Hydraulische Neigungsvorrichtung mit Schwimmstellung-System und Sperrventil.
- Höhenverstellbar und selbstreinigende Stützwalze Ø 159.
- Automatische Riemenspannung.
- Schlegel BERTI Typ "A" oder "Y"-Messer.
- Gegenschneiden.
- Verstärkte Gelenkwelle.
- Getriebe 540 U/min.
- Unfallschutz laut EG-Normen.

Der Traktor muss mit 2 DW Hydraulikanschlüssen ausgestattet sein



Équipement standard

- Boîtier au dehors de la structure de la machine.
- Coin côté droite arrondi.
- Attelage à 3 points, Cat. II avec système flottant et arrêt de sécurité.
- Déchargement postérieur réglable.
- Roue libre dans le boîtier.
- Déport hydraulique avec soupape de sûreté.
- Double caisse.
- Inclinaison hydraulique avec système flottant et soupape de bloc.
- Rouleau palpeur autonettoyant Ø 159.
- Tendeur automatique des courroies.
- Marteaux BERTI forgés et trempés type "A" ou couteaux "Y".
- Contre couteaux.
- Arbre cardan à profil renforcé.
- PDF 540 t/min.
- Protections selon normes CE.

Le tracteur doit être équipé avec au moins 2 prises d'huile à double effet

Mod.									
	cm	Min	Max	n°	n°	n°	PTO	min	max
TA/S 160	160	60	110	14	42	4	540	810	915
TA/S 180	180	60	110	16	48	4	540	845	955
TA/S 200	200	60	110	18	54	4	540	885	1005
TA/S 220	220	60	110	20	60	4	540	925	1055



www.bertima.it



BMP - BML



BMG



STAR



FRUTTI



HANDY



FLEXY



FLEXY/T



VARY/W

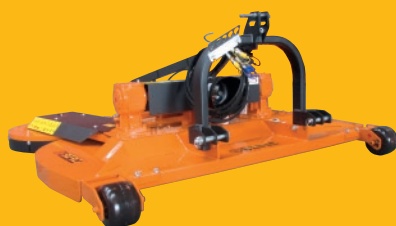

VARY



VARY/K

Le illustrazioni e i dati del presente catalogo sono indicative e non vincolanti per il costruttore • All pictures and data above are indicative only and not binding for the manufacturer • Alle in diesem Katalog enthaltenen Angaben und Zeichnungen sind annähernd und unverbindlich • Toutes les données insérées dans ce catalogue ont été indiquées seulement à titre de renseignement • Las fotografías y los datos mostrados son meramente indicativos y podrían ser variados sin previo aviso por el fabricante.



BERTI
MACCHINE AGRICOLE



Via Musi, 1/A-3 - 37042 Caldiero (VR) ITALY
Tel. +39.045.6139711 - Fax +39.045.6150251
info@bertima.it



MADE IN ITALY



Click here for ordering programs - Select program #4 from bookmarks

AMP SERIES PENDULUM SPREADERS

BMC pendulum spreaders are designed to accurately spread granular fertilizer and seeds. Virtually anything that will flow can be spread.

DISTRIBUTION SYSTEM

Pendulum spreaders deliver the most accurate overlapping spread pattern possible. An equal amount of material is spread on either side in a symmetrical pattern. The maximum spreading width is 46 feet. The overlapping pattern allows for more driving forgiveness. No skips or burns due to double coverage. Material is kept close to the machine and there is no overspray on to the tractor.



FEATURES

- All spreader models use the same pendulum gearbox and drive system. The only differences are in frame and hopper sizes.
- 3 base models: AIP500, AIG800 and ASG1100. All other models are made by adding bolt on extensions to the base hoppers.
- Hoppers are made of high grade pressed polyester. Critical parts are stainless steel, poly or high grade paint.
- AIG and ASG models come with quick hitch system.
- Accessories include: Hydraulic open/close, agitator extension, hopper covers, and specialty spouts.

ITEMNUMBER	DESCRIPTION	WEIGHT	PRICE
AMP300	AMP Spreader - Hopper Capacity Approx. 10.6 Cubic Feet W/Poly-Ethylene Hopper	185	\$2,502.00

AMP 300 SERIES



AMP series has a poly-ethylene hopper and is capable of spreading powders or granules. It's compact design and short spreading surface makes it perfect for small areas. Requires CAT I 3-point hitch, 540 RPM PTO.

Hopper Capacity (Cubic Feet)	10.6 CF
Approx. Hopper Capacity (Pounds)	660 lbs.
Approx. Bushel Capacity	8.5
Spreading Width	3'-46'
Total Weight	185 lbs.

AIP SERIES PENDULUM SPREADERS

ITEMNUMBER	DESCRIPTION	WEIGHT	PRICE
AIP500	AIP 500 Pendulum Spreader - Hopper Capacity Is Approx. 17.65 Cubic Feet/1,190 lbs.	234	\$2,778.00
AIP600	AIP 600 Pendulum Spreader - Hopper Capacity Is Approx. 21.19 Cubic Feet/1,428 lbs.	247	\$3,015.00

VITI SERIES NARROW VINEYARD PENDULUM SPREADERS

ITEMNUMBER	DESCRIPTION	WEIGHT	PRICE
VITI500	VITI 500 Narrow Vineyard Pendulum Spreader - Hopper Capacity Is Approx. 17.65 Cubic Feet/1190lbs.	234	\$2,844.00
VITI600	VITI600 Narrow Vineyard Pendulum Spreader - Hopper Capacity Is Approx. 21.2 Cubic Feet/1428 lbs. - VITI500 W/P0506 Extension	247	\$3,081.00

AIP SERIES

30 HP or higher
Tractor 3PH: CAT 1 & 2
PTO: 540RPM – Shear Bolt

MODELS	AIP 500	AIP 600
Hopper Capacity (Cubic Feet)	17.65 CF	21.19 CF
Approx. Hopper Capacity (Pounds)	1,190 lbs.	1,428 lbs.
Approx. Bushel Capacity	14	17
Spreading Width	46'	46'
Dimensions	36" high x 42" long x 54" wide	42" high x 43" long x 55" wide
Total Weight	234 lbs.	247 lbs.

Vineyard Spreader





36" high x 54" long x 42" wide
17.54 CF / 1,190 lbs. capacity*

*VITI600 is the same as the VITI500 with a P0506 hopper extension which increases capacities to 21.2 CF / 1428 lbs.

**AIG SERIES PENDULUM SPREADERS**

ITEMNUMBER	DESCRIPTION	WEIGHT	PRICE
AIG800	AIG 800 Pendulum Spreader - Hopper Capacity Is Approx. 28.25 Cubic Feet/1,904 lbs.	335	\$3,265.00
AIG1000	AIG 1000 Pendulum Spreader - Hopper Capacity Is Approx. 35.31 Cubic Feet/2,380 lbs.	348	\$3,581.00
AIG1250	AIG 1250 Pendulum Spreader - Hopper Capacity Is Approx. 42.4 Cubic Feet/2,856 lbs.	353	\$3,765.00

AIG SERIES

30 HP or higher Tractor 3PH: CAT 2 w/Quick Hitch PTO: 540RPM – Shear Bolt			
MODELS	AIG 800	AIG 1000	AIG 1250
Hopper Capacity (Cubic Feet)	28.25 CF	35.31 CF	42.4 CF
Approx. Hopper Capacity (lbs.)	1,904 lbs.	2,380 lbs.	2,856 lbs.
Approx. Bushel Capacity	23	28	34
Spreading Width	46'	46'	46'
Dimensions	39" high x 53" long x 74" wide	42" high x 54" long x 75" wide	46" high x 54" long x 75" wide

ASG SERIES PENDULUM SPREADERS

ITEMNUMBER	DESCRIPTION	WEIGHT	PRICE
ASG1100	ASG 1100 Pendulum Spreader - Hopper Capacity Is Approx. 38.8 Cubic Feet/2,618 lbs.	459	\$4,037.00
ASG1400	ASG 1400 Pendulum Spreader - Hopper Capacity Is Approx. 49.4 Cubic Feet/3,332 lbs.	472	\$4,339.00
ASG1650	ASG 1650 Pendulum Spreader - Hopper Capacity Is Approx. 58.27 Cubic Feet/3,927 lbs.	481	\$4,589.00

ASG SERIES

50 HP or higher Tractor 3PH: CAT 2 w/Quick Hitch PTO: 540RPM – Shear Bolt			
MODELS	ASG 1100	ASG 1400	ASG 1650
Hopper Capacity (Cubic Feet)	38.8 CF	49.4 CF	58.27 CF
Approx. Hopper Capacity (lbs.)	2,618 lbs.	3,332 lbs.	3,927 lbs.
Approx. Bushel Capacity	31	39	46
Spreading Width	46'	46'	46'
Dimension	43" high x 65" long x 74" wide	49" high x 66" long x 75" wide	53" high x 66" long x 75" wide

PENDULUM SPREADER ACCESSORIES

ITEMNUMBER	DESCRIPTION	PRICE
3028	Fine Seed Kit For BMC Spreaders	\$66.00
ACC	Lime Agitator For All Pendulum Spreaders Except AMP Series	\$126.00
AHC	Hydraulic Opening For BMC Spreader	\$316.00
DP1114	Hopper Extension For ASG Series Spreaders - Adds An Extra 10.6 CF to ASG1100 Spreaders - 6.7" High	\$280.00
DP1117	Hopper Extension ASG Series Spreaders - Turns ASG1100 Into ASG1650, Adds 19.4 CF, 10.3" High	\$553.00
P0506	Hopper Extension AIP Series Spreaders - Turns AIP500 Into AIP600, Adds 3.5 CF, 5.5" High	\$237.00
P0811	Hopper Extension AIG Series Spreaders - Turns AIG800 Into AIG1000, Adds 7.1 CF, 3.6" High	\$316.00
P0812	Hopper Extension AIG Series Spreaders - Turns AIG800 Into AIG1250, Adds 14.1 CF, 7.6" High	\$500.00
AMP300HC	Hopper Cover - AMP300 Spreaders	\$160.00
AIPHC	Hopper Cover - AIP/VITI Spreaders	\$180.00
AIGHC	Hopper Cover - AIG Spreaders	\$165.00
KIT6N	Pendular Spout - Standard Spout On All Pendulum Spreaders, Quick Attach	\$81.30
KIT6BL	One Way Spout - Left Hand	\$38.00
KIT6BR	One Way Spout - Right Hand	\$38.00
KIT6BS	Two Sided Banding Spout - 3.5", 5' To 11' Spread Pattern	\$424.00
KIT6BG	Two Sided Banding Spout - 19", 7'-26' Spread Pattern	\$446.00
KIT6S	Salt Spout - 10' To 16' Spread, Bolt-On	\$96.45

**TWIN DISC SPREADERS**
SYNTRA TWIN DISC SPREADERS

ITEMNUMBER	DESCRIPTION	WEIGHT	PRICE
SYNTRA800	Twin Disc Spreader 29CF, Hydraulic Control, 1900# Capacity, 72' Spread Width	495	\$4,414.00
SYNTRA1000	Twin Disc Spreader 36CF, Hydraulic Control, 2300# Capacity, 72' Spread Width	550	\$4,809.00
SYNTRA1200	Twin Disc Spreader 42CF, Hydraulic Control, 2688# Capacity, 72' Spread Width	600	\$5,440.00
SYNTRA1500	Twin Disc Spreader 53CF, Hydraulic Control, 3392# Capacity, 72' Spread Width	675	\$6,072.00

SYNTRA SPREADER ACCESSORIES

ITEMNUMBER	DESCRIPTION	PRICE
LOSYNTRA800	Hopper Cover - For SYNTRA800	\$421.00
LOSYNTRA	Hopper Cover - For Syntra 1000-1200-1500	\$407.00
LOCSYNTRA	Two Sided Banding Spout - For Syntra Models	\$842.00

TWIN DISC SPREADERS

Twin disc spreaders deliver a uniform distribution & perfect scatter from 72' up to 79'. Designed for solid granular fertilizers & seeds.

**SYNTRA****ADH****ACH**

MODELS		72'				79'			79'			
Hopper Capacity	Cubic Ft.	29	36	42	53	35	49	58	52	71	88	106
	lbs.	1,900	2,300	2,688	3,392	2,359	3,303	3,937	3,572	4,785	5,931	7,144
	Bushels	23	29	-	-	28	39	47	42	57	71	85
Spreading Width		72'				79'			79'			
Dimensions length x width x height		59"x59"x50"	53"x71"x47"	44"x71"x48"	44"x71"x48"	65"x74"x43"	66"x75"x49"	66"x75"x54"	60"x93"x49"	60"x100"x55"	60"x100"x61"	60"x100"x63"
Total Weight lbs.		495	550	600	675	536	549	558	944	989	1,024	1,069

ADH-ACH TWIN DISC SPREADERS

ITEMNUMBER	DESCRIPTION	WEIGHT	PRICE
ADH1100	Twin Disc Spreader 35 CF, Hydraulic Control, 2359# Capacity, 39-79' Spread Width	536	\$6,256.00
ADH1400	Twin Disc Spreader 49CF, Hydraulic Control, 3303# Capacity, 39-79' Spread Width	561	\$6,598.00
ADH1650	Twin Disc Spreader 58CF, Hydraulic Control, 3937# Capacity, 39-79' Spread Width	596	\$6,966.00
ACH1500	Twin Disc Spreader 53CF, Hydraulic Control, 3572# Capacity, 39-79' Spread Width	944	\$8,480.00
ACH2000	Twin Disc Spreader 71CF, Hydraulic Control, 4785# Capacity, 39-79' Spread Width	989	\$8,980.00
ACH2500	Twin Disc Spreader 88 CF, Hydraulic Control, 5931# Capacity, 39-79' Spread Width	1024	\$9,453.00
ACH3000	Twin Disc Spreader 106CF, Hydraulic Control, 7144# Capacity, 39-79' Spread Width	1096	\$10,085.00

ADH-ACH SPREADER ACCESSORIES

ITEMNUMBER	DESCRIPTION	PRICE
LINDER	Border Spreading Plate - ADH/ACH Series Twin Disc Spreaders	\$816.00
LO1500	Folding Hopper Cover - ACH 1500 Model Twin Disc Spreaders	\$737.00
LO2000	Folding Hopper Cover - ACH 2000/2500/3000 Model Twin Disc Spreaders	\$842.00

STANDARD**OPTIONS**



TWIN DISC SPREADERS

KOPA TWIN DISC SPREADERS

ITEMNUMBER	DESCRIPTION	WEIGHT	PRICE
KOPA1500	Twin Disc Spreader, 3,500# Capacity	926	\$8,622.00
KOPA2000	Twin Disc Spreader, 4,785# Capacity	970	\$9,122.00
KOPA2500	Twin Disc Spreader, 5,930# Capacity	1014	\$9,596.00
KOPA3000	Twin Disc Spreader, 7,144# Capacity	1058	\$10,228.00

KOPA SERIES

Twin disc spreader designed for 100 HP or higher. Spreading width up to 118'

FEATURES

- 720 RPM Per Disc
- 2 Vanes Per Disc
- Recommended Tractor Speed (MPH) 8, 10 or 12
- Powder Coat Paint



STANDARD



Inner Screen

OPTIONAL



Border



Hopper Cover

	1500	2000	2500	3000
Hopper Capacity (Cubic Feet)	53	71	88	106
Hopper Capacity (lbs.)	3500	4785	5930	7144
Height	75"	78"	81"	85"
Width	93"	93"	93"	93"
Machine Weight (lbs.)	926	970	1014	1058

KOPA SPREADER ACCESSORIES

ITEMNUMBER	DESCRIPTION	PRICE
LO1500KOPA	Folding Hopper Cover - KOPA 1500 Model Twin Disc Spreader	\$737.00
LO2000KOPA	Folding Hopper Cover - KOPA 2000/2500/3000 Model Twin Disc Spreaders	\$842.00
KOPALIND	Border Kit For KOPA Spreaders	\$816.00



CUMMINGS and BRICKER INC.

www.cummingsandbricker.com
support@cummingsandbricker.com



 = C&B distribution area

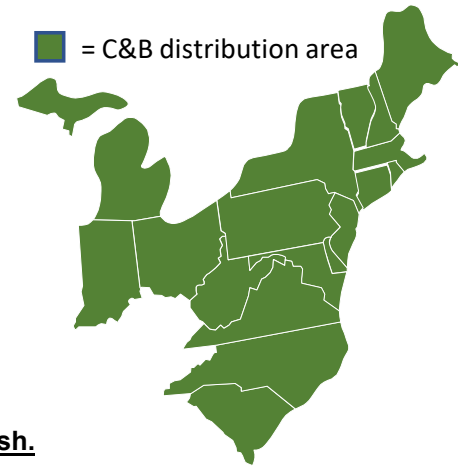

GENERAL INFORMATION

Brush Wolf cutters are designed to cut and mulch brush.

Brush Wolf cutters mulch the material cut. There is no side or rear discharge point. Cutters are operated with the front slightly raised, allowing the material to be discharged away from the operator.

Safety chains are supplied with each cutter. The chain attaches to the tie-down loop in the center of the skid steer frame under the cab entry.

For safety purposes, the chain prevents the rear of the cutter from being raised.

Skid steer bucket cylinders tilt the front of the cutter up and down as required during operation.

Generic flat faced couplers are standard with machines. High Flow units are equipped with larger generic flat faced couplers. Other couplers must be sourced by the dealer or customer.

Points to consider when pricing and sizing machines

4000 Series:

“Standard” hookup for Model 4200B is for Toro Dingo, Ditch Witch, Ramrod, and Vermeer skid steers. If a universal “Bobtach” hookup is required, specify when ordering and designate the model as 4200BOBCAT.

“Standard” hookup for Model 4800LF is for ASV RC30 skid steer. Specify what skid steer the unit is for if other than an RC30.

Model 4800B is equipped with a universal Skid Steer hookup.

X Series:

“X” Series cutters are designed for excavators.

Prices **do not include** the mounting plate to attach the cutter to the excavator. Hanger bracket prices vary from \$600- \$2,500 depending on the excavator model.

When sizing an “X” series cutter, it’s important to know the flow and pressure available at the “stick”(end of the boom). This flow rate is often different than the overall flow rate shown for the whole machine. Factory guidance on model selection is recommended.

6000, 7000, and 9000 Series:

Models 6000 through 9000 are standard with universal Skid Steer hookup.

Flow Requirements

All machines will operate within a range of hydraulic flow. Optimum flow indicates the best combination of tip speed and torque. Refer to the specification chart for range and optimum flow.

Skid steer flow below 15 GPM, Low Flow models recommended.

Skid steer flow above 30 GPM requires High Flow models.

100-120 LEHIGH AVE.
P.O. BOX 928
BATAVIA, NY 14021-0928
PHONE: 800-252-1552 FAX: 888-852-7406

100 STOVER DRIVE
CARLISLE, PA 17015-9782
PHONE: 800-222-8969
FAX: 717-249-9384



CUMMINGS and BRICKER INC.

www.cummingsandbricker.com
support@cummingsandbricker.com



Selling Points

1. Over 20 years of experience building brush cutters.
2. ASAE compliant: Hose sleeves, 3000# rated hoses, 3800# rated hydraulic motors.
3. 1/4" decks reinforced in front with 3/8"x2" "V" shaped nose angle.
4. Non-slip step for entry to skid steer.
5. Deck cannot be bent by lifting. Flux core welded bracing and flared skids for easy maneuverability.
6. Wear runners extend up the front of the deck so it can be used to clear deadfall logs.
7. Galvanized 5/16" safety chains front and rear.
8. Gearbox and motor preassembled onto a 1/2" steel plate, and then welded onto the deck. This eliminates misalignment problems.
9. Shear bolt protected at motor coupler.
10. Balanced stump jumper.
11. Welded collar on the bottom of the deck prevents weeds and wire from damaging gearbox seal.
12. Castle nut holding stump jumper and blade assembly does not extend below the stump jumper which prevents damage to threads on the shaft.
13. Counterclockwise blade rotation with high lift blades. Research shows that counterclockwise rotation provides better performance.
14. Top lock nut on blades for extra safety.
15. Built in safety cushion valve stops blades quickly when hydraulic flow is shut off.
16. Widest range of models available on the market.
17. Powder coated paint

[Click Here For Brush Wolf Videos](#)

Skid Steer models



"X" Series for excavators



100-120 LEHIGH AVE.
P.O. BOX 928
BATAVIA, NY 14021-0928
PHONE: 800-252-1552 FAX: 888-852-7406

100 STOVER DRIVE
CARLISLE, PA 17015-9782
PHONE: 800-222-8969
FAX: 717-249-9384



CUMMINGS & BRICKER

www.cummingsandbricker.com
support@cummingsandbricker.com

Effective: 02/01/2021

F.O.B. C&B



[Click here for ordering programs-Select Program #4 from Bookmarks](#)

Standard Duty Cutters

ITEMNUMBER	DESCRIPTION	WEIGHT (lbs.)	PRICE
SD6000LF	Brush Cutter 60" Low Flow - Skidsteer, 10-15 GPM	970	\$5,780.00
SD6000B	Brush Cutter 60" Standard Flow - Skidsteer, 16-25 GPM	970	\$5,769.00
SD7200LF	Brush Cutter 72" Low Flow - Skidsteer, 15-20 GPM	1168	\$6,141.00
SD7200B	Brush Cutter 72" Standard Flow - Skidsteer, 21-25 GPM	1168	\$6,152.00

The standard duty cutters are designed to cut up to 2" diameter. Hoses and couplers are included. One year warranty on the structural steel.



Universal Pick-Up Plate



Blade Carrier



	SD6000LF	SD6000B	SD7200LF	SD7200B
Width	60	60	72	72
Length	61.75	61.75	73.75	73.75
Blade Carrier Type	1.000 Bar Welded to .313 Spun Formed High Strength Steel			
Blades	(2) .5000 x 4.000 (High Strength, Updraft)			
Blade Rotation	Counter Clockwise			
Cutting Capacity MAX	2"	2"	2"	2"
Motor Protection	Pressure Reliefs			
Deck Thickness	.250 One Piece of Formed Steel			
Required GPM	10 - 15	16 - 25	15 - 20	21 - 25
PSI Min/Max	3000/3500	3000/3500	3000/3500	3000/3500
Weight (lbs.)	970 lbs.	970 lbs.	1,168 lbs.	1,168 lbs.



Heavy Duty Cutters



Before



After



4200 Series



4800 Series



6000 Series



7201 (Open Front)

Low Flow

ITEMNUMBER	DESCRIPTION	WEIGHT (lbs.)	PRICE
4200B	Brush Wolf 42" Low Flow w/Dingo Hookup	510	\$4,607.00
4200BOBCAT	Brush Wolf 42" Low Flow w/ Bobcat Mini Hookup	470	\$4,607.00
4800LFASV	Brush Wolf 48" Low Flow w/ASV RC30 Hookup	725	\$5,469.00
6000LF	Brush Wolf 60" Low Flow	1000	\$6,119.00
6600LF	Brush Wolf 66" Low Flow	1020	\$6,457.00

Standard Flow

ITEMNUMBER	DESCRIPTION	WEIGHT (lbs.)	PRICE
4800B	Brush Wolf 48" Standard Flow w/Bobtach Hookup	725	\$5,492.00
6000B	Brush Wolf 60" Standard Flow	1000	\$6,172.00
6600B	Brush Wolf 66" Standard Flow	1100	\$6,457.00
7200B	Brush Wolf 72" Standard Flow	1210	\$6,685.00
7201B	Brush Wolf Open Front 72" Standard Flow	1225	\$7,029.00
7800B	Brush Wolf 78" Standard Flow	1308	\$6,993.00
9000B	Brush Wolf 90" Standard Flow	1900	\$10,742.00

High Flow

ITEMNUMBER	DESCRIPTION	WEIGHT (lbs.)	PRICE
6600HF	Brush Wolf 66" High Flow	1300	\$8,074.00
7200HF	Brush Wolf 72" High Flow	1250	\$8,332.00
7201HF	Brush Wolf 72" Open Front High Flow	1225	\$8,691.00
7800HF	Brush Wolf 78" High Flow	1400	\$8,656.00
9000HF	Brush Wolf 90" High Flow	2145	\$12,707.00



Heavy Duty Cutters

MODEL	4200	4800 LF	4800	6000 LF	6000	6600LF	6600	6600 HF
OVERALL WIDTH	43 3/4"	49 3/4"	49 3/4"	61 3/4"		67 3/4"		
OVERALL LENGTH	58 1/4"	60"	60"	72 1/4"		78 1/4"		
BLADE CARRIER TYPE	1" Thick GRD-50 Bar			1" Thick GRD-50 Bar Welded To .313 Spun Formed GRD-50 High Strength Steel				
BLADES	1/2" X 4"		1/2" X 4"					
BLADE ROTATION	CCW							
CUTTING CAPACITY MAX.	2"	3"	4"	3"	4"	3"	4"	6"
MOTOR PROTECTION	Pressure Relief							
DECK THICKNESS	10 GA.	7 GA.			1/4"			
REQUIRED GPM	8 - 20	8 - 15	16 - 25	10 - 15	16 - 25	10-15	16 - 25	26 - 40
OPTIMUM GPM	14	14	24	14	24	25	25	35

MODEL	7200LF	7200/7201B	7200/7201 HF	7800	7800 HF	9000	9000 HF
OVERALL WIDTH	73 3/4"		79 3/4"			93 1/4"	
OVERALL LENGTH	84 1/4"			90 1/4"		76 1/4"	
BLADE CARRIER TYPE	1" Thick GRD-50 Bar Welded To .313 Spun Formed GRD-50 High Strength Steel						
BLADES	1/2 X 4"				1/2 X 4"		
BLADE ROTATION	CCW					Off Set CCW	
CUTTING CAPACITY MAX.	3"	4"	6"	4"	5"	4"	5"
MOTOR PROTECTION	Pressure Reliefs						
DECK THICKNESS	1/4"						
REQUIRED GPM	15 - 20	21-25	26 - 40	20 - 25	26 - 40	20 - 25	26 - 40
OPTIMUM GPM	24		35	24	35	24	35

***7201B Open Front Brush Cutters cut through heavy brush without stopping to raise and lower the cutter.**

STANDARD FEATURES ON ALL MODELS

DRIVE PROTECTION - GR2 BOLT

PSI MIN. / MAX. - 2500/3500

FLAT FACE COUPLINGS

MOTOR / GEARBOX COUPLER - MACHINED STEEL

NYLON HOSE SLEEVES

GEARBOX SEAL GUARD

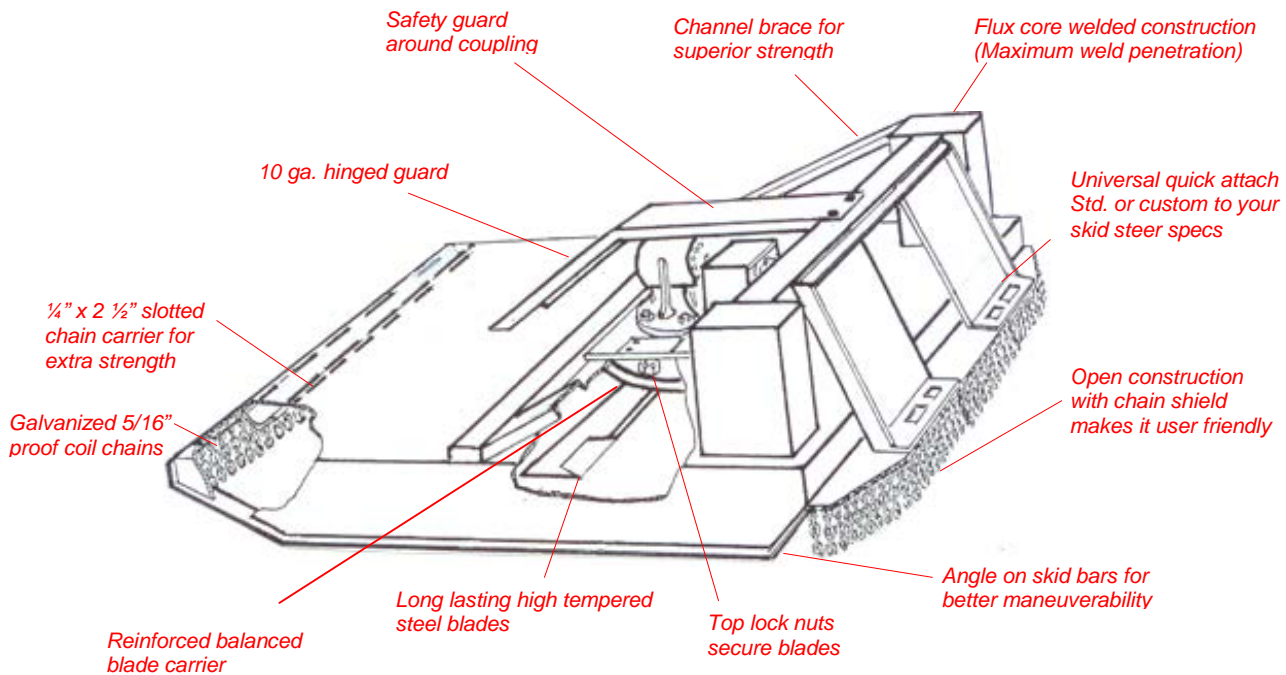



CUMMINGS & BRICKER

www.cummingsandbricker.com
support@cummingsandbricker.com

Effective: 02/01/2021

F.O.B. C&B



ALPHA EXTREME DUTY BRUSH CUTTER

ITEMNUMBER	DESCRIPTION	WEIGHT (lbs.)	PRICE
ALPHAHD	72" Cutting Width - 10" Capacity, Direct Drive, Skidsteer, 23-32GPM	2318	\$15,006.00
ALPHAHDFB	72" Cutting Width - 10" Capacity, Direct Drive, 4 Flat Blade, Skidsteer, 23-32GPM	2568	\$18,049.00
ALPHAXP	72" Cutting Width - 10" Capacity, HF Direct Drive, Skidsteer, 33-45GPM	2318	\$15,006.00
ALPHAXPFB	72" Cutting Width - 10" Capacity, Direct Drive, 4 Blade, Skidsteer, 33-45GPM	2568	\$18,049.00

EXTREME DUTY CUTTERS



SPECIFICATIONS	ALPHAHD Series	ALPHAXP Series
	Standard Flow (23-33 GPM)	High Flow (33-45GPM)
OVERALL WIDTH	75-1/4"	75-1/4"
OVERALL LENGTH	82"	82"
BLADE CARRIER TYPE	(1) 1" Disc (2) 5/8" Discs High Strength (Optional)	(1) 1" Disc (2) 5/8" Discs High Strength (Optional)
BLADES (3)	(3) 5/8" x 5" High Strength (4) 5/8" x 5.188" High Strength, Flat Blade (Optional)	(3) 5/8" x 5" High Strength (4) 5/8" x 5.188" High Strength, Flat Blade (Optional)
CUTTING CAPACITY MAX	10"	10"
DRIVE	Direct Drive Piston Motor	Direct Drive Piston Motor
MOTOR PROTECTION	Pressure Relief, Case Drain	Pressure Relief, Case Drain
DECK THICKNESS	1/4" Formed Steel	1/4" Formed Steel
HOSE SLEEVES	Standard	Standard
FLAT FACE COUPLINGS	Standard	Standard
BEARING HOUSING GUARD	Standard	Standard
PSI MIN. / MAX	3000/4100	3000/4100
WEIGHT (LB)	2,318 LBS. (4 Blade - 2568 LBS.)	2,318 LBS. (4 Blade - 2568 LBS.)



EXCAVATOR MODELS

**Hoses and couplers included*

"X" Series cutters are designed for excavators.

4200X and 4800X for mini excavators, 6000X and 6600X for larger machines.

Prices do not include the hanger bracket to attach the cutter to the excavator. Hanger bracket prices vary depending on the excavator model.

When sizing an "X" series cutter it's important to know the flow and pressure available at the "stick"(end of the boom). This flow rate is often different than the overall flow rate shown for the whole machine. Factory guidance on model selection is recommended.



MODEL	4200X	4800X	4800XHF	4800XLF	6000X	6000XHF	6600X	6600 XHF
OVERALL WIDTH	45"	51"	51"	51"	63 1/4"	63 1/4"	69 1/4"	69 1/4"
OVERALL LENGTH	57"	63"	63"	63"	75"	75"	81"	81"
BLADE CARRIER	1" Thick GRD-50 Steel Disc High Strength Steel				1" Thick GRD-50 Bar Welded To .313 Spun Formed GRD-50 High Strength Steel			
BLADES	1/2" X 4"	1/2" X 4"	1/2" X 4"	1/2" X 4"	1/2" X 4"	1/2" X 4"	1/2" X 4"	1/2" X 4"
BLADE ROTATION	CCW	CCW	CCW	CCW	CCW	CCW	CCW	CCW
MAX. CUTTING	3"	4"	5"	3"	4"	5"	4"	5"
DECK THICKNESS	10 GA.	7 GA.	7 GA.		1/4"	1/4"	1/4"	1/4"
REQUIRED GPM	8 - 20	16 - 25	26-40	8-15	16-25	26 - 40	16 - 25	26 - 40
OPTIMUM GPM	14	24	35	14	24	35	24	35
PSI MIN/MAX	3000/3500	3000/3500	3000/4100	3000/3500	3000/3500	3000/4100	3000/3500	3000/4100
WEIGHT (LBS.) (approx.)	690	880	968	880	1332	1384	1434	1486
MOTOR PROTECTION	Pressure Reliefs							

MODEL	42X	48X	60XHD	60XP	72XHD	72XXP
POWER UNIT	Mini Excavator/ Backhoe	Mini Excavator/ Backhoe	Excavator/ Backhoe	Excavator/ Backhoe	Excavator/ Backhoe	Excavator/ Backhoe
OVERALL WIDTH	53"	55 1/2"	72 1/4"	72 1/4"	82"	87"
OVERALL LENGTH	57"	63"	74 1/2"	74 1/2"	87"	87"
CUTTING WIDTH	42"	48"	60"	60"	72"	72"
BLADE CARRIER	1" Disc, High Strength Steel		1" Disc, High Strength Steel		1" Thick GRD-50 Bar Welded To .313 Spun Formed GRD-50 High	
BLADES	(2) 1/2" X 4"		(3) 5/8" X 5" Drop Blades (4) Flat Blades Optional		(3) 5/8" X 5" Drop Blades (4) Flat Blades Optional	
BLADE ROTATION	CCW	CCW	CCW	CCW	CCW	CCW
MAX. CUTTING	4"	5"	10"	10"	10"	10"
DECK THICKNESS	10 GA.	7 GA.	3 GA.	3 GA	3 GA	3 GA
REQUIRED GPM	14 - 23	17 - 29	20-32	33-45	20-32	33-45
DRIVE PROTECTION	Pressure Reliefs		Pressure Reliefs, Case Drain		Pressure Reliefs, Case Drain	



CUMMINGS & BRICKER

www.cummingsandbricker.com
support@cummingsandbricker.com

Effective: 02/01/2021

F.O.B. C&B



EXCAVATOR MODELS

ITEMNUMBER	DESCRIPTION	WEIGHT (lbs.)	PRICE
4200X	Brush Wolf 42" Mini Ex-Low Flow (Price Hanger Bracket Separately)	690	\$5,441.00
4800X	Brush Wolf 48" Mini Ex-Standard Flow (Price Hanger Bracket Separately)	770	\$5,986.00
4800XHF	Brush Wolf 48" Mini Ex-High Flow (Price Hanger Bracket Separately)	770	\$7,515.00
4800XLF	Brush Wolf 48" Mini Ex-Low Flow (Price Hanger Bracket Separately)	770	\$6,224.00
42XHD	42" Rotary Cutter - Direct Drive-Piston Motor, 14-23 GPM - Add Hanger	710	\$8,455.00
48XHD	48" Rotary Cutter - Direct Drive-Piston Motor, 17-29 GPM - Add Hanger	806	\$8,745.00
60XHD	60" Rotary Cutter - Drop Blades, Direct Drive-Piston Motor, 20-32 GPM - Add Hanger	1300	\$12,875.00
60XHDFB	60" Rotary Cutter - Flat Blades, Direct Drive-Piston Motor, 20-32 GPM - Add Hanger		\$15,478.00
60XXP	60" Rotary Cutter - Drop Blades, Direct Drive-Piston Motor, 33-45 GPM - Add Hanger	1300	\$13,639.00
60XXPFB	60" Rotary Cutter - Flat Blades, Direct Drive-Piston Motor, 33-45 GPM - Add Hanger		\$16,244.00
72XHD	72" Rotary Cutter - Drop Blades, Direct Drive-Piston Motor, 23-32 GPM - Add Hanger	1700	\$14,561.00
72XHDFB	72" Rotary Cutter - Flat Blades, Direct Drive-Piston Motor, 20-32 GPM - Add Hanger	1900	\$17,103.00
72XXP	72" Rotary Cutter - Drop Blades, Direct Drive-Piston Motor, 33-45 GPM - Add Hanger	1700	\$14,561.00
72XXPFB	72" Rotary Cutter - Flat Blades, Direct Drive-Piston Motor, 33-45 GPM - Add Hanger	1900	\$17,103.00

**HOW TO PRICE
AN X CUTTER:**

1. Choose Cutter
2. Choose Mounting Plate (or blank mount)
3. Choose Pins (if needed)

****Add the required hanger brackets (ears) which vary in price from \$973 to \$4375 depending on brush cutter and excavator models. Quotes provided on request. Blank hanger plates are available if you choose to outsource your hanger bracket.****

HANGER MOUNTING PLATES

ITEMNUMBER	DESCRIPTION	PRICE
16556	Hanger Plate - Welded, Painted **Add Hanger For 4200X**	\$643.00
16557	Hanger Plate - Welded, Painted **Add Hanger For 42X/48X/4800X**	\$659.00
16558	Hanger Plate - Welded, Painted **Add Hanger For 60X/72X/6000X/6600X**	\$932.00

Blank Hanger Plates

ITEMNUMBER	DESCRIPTION	PRICE
15183	Hanger Plate - No Ears, Unpainted - For 4200X	\$118.00
15843	Hanger Plate - No Ears, Unpainted - For 48X/4800X	\$134.00
15844	Hanger Plate - No Ears, Unpainted - For 60X/72X/6000X/6600X	\$232.00

X MOUNT HANGER PINS

ITEMNUMBER	DESCRIPTION	PRICE
XPINS40	X Mount Hanger Pin Set 40MM	\$404.00
XPINS45	X Mount Hanger Pin Set 45MM	\$539.00
XPINS50	X Mount Hanger Pin Set 50MM	\$621.00
XPINS55	X Mount Hanger Pin Set 55MM	\$641.00
XPINS60	X Mount Hanger Pin Set 60MM	\$679.00
XPINS65	X Mount Hanger Pin Set 65MM	\$854.00
XPINS70	X Mount Hanger Pin Set 70MM	\$938.00
XPINS80	X Mount Hanger Pin Set 80MM	\$1,008.00

CHAIN GUARDS

ITEMNUMBER	DESCRIPTION	WEIGHT (lbs.)	PRICE
16479	Chain Curtain Guard - For 42X, Order 1 Or 2	36	\$418.00
16549	Chain Guard - 48X, Order 1 Or 2	45	\$465.00
16578	Chain Curtain Guard - For 60X Order 1 Or 2	64	\$654.00
16624	Chain Curtain Guard - For 72X, Order 1 Or 2	79	\$762.00