



2024 PRICE BOOK



PLANT 1



PLANT 2



Cummings and Bricker

Warranty

ONE YEAR LIMITED CONSUMER WARRANTY

Warranty is active at the time of customer delivery and any claims require the product model and serial number.

All claims must be discussed with a representative from the distributor prior to any repairs / replacement or warranty will be void.

This new and unused product is warranted by Horst Welding, to be free from defects in material and workman-ship under normal use and regular service as described in the owner's manual, for a period of 1 year from the date of delivery. Warranty is limited to the repair of the product and / or replacement of parts.

Customer: If issues develop within the warranty period with the product, contact the local dealer from which you purchased the unit. Only Horst authorized dealers may make repairs to the product or affect the replacement of defective parts, unless otherwise approved by Horst.

Distributor / Dealer: must notify Horst Welding of the defect before repair / replacement is made. Recommended repairs / re-placement and cost are to be discussed with, and agreed on, by an authorized Horst Welding representative. All claims must be accompanied by a photograph of the defective product.

Defective products may be required to be returned to Horst Welding in Listowel, Ontario at the request of Horst Welding. Repairs / Replacement will be done at no charge to the customer within a reasonable time after the receipt of the product.

This warranty does not cover the following items:

1. Normal replacement of service items.
2. Normal maintenance or adjustments.
3. Machines or parts lost or damaged during shipment,
4. Accessory items / parts not supplied by Horst Welding
5. Damages resulting from:
 - misuse, negligence, accident, theft or fire
 - use of improper or insufficient fuel, fluids or lubricants
 - use of after market parts or accessories, unless approved by Horst Welding
 - modifications, alteration, tampering or improper repair
 - any device or accessories installed other than an authorized dealer.
 - using incorrect supplies or supplies not specified in the owners manual.

Horst shall not, in any event, be liable for any losses, damages or costs; to include profits, travel, transportation, pick up, delivery, towing cost, tow vehicle, loss of use, whether special, incidental, consequential or otherwise, in any way. Unit or parts are returned at the customer's expense.

There are no warranties, expressed or implied, other than those specified herein. No agent, employee or other person has any authority to vary any of the foregoing provisions.

All claims must be discussed with a representative from the distributor prior to any repairs.

To Determine Price

1. First determine Price Code by finding your particular loader or skidsteer model (in back of price book)
2. Find your particular attachment
3. Use applicable Price Code

Example: For 72" Standard Material Bucket to fit JD 146 loader
Price Code B
Price would be \$1666.00

To Order

1. Combine Part # of attachment with Part # of loader model

Example: For 72" Standard Material Bucket to Fit JD 146 loader
Part # of bucket is MB72
Part # of loader is JD146
Join both numbers (attachment Part # first) to make Part# MB72JD146

Note

To price HLA attachments less loader mounts, deduct \$122.00 from Price Code A

Although the information presented in this price list is believed to be accurate and reliable, no responsibility for inaccuracies can be assumed by Horst Welding.
Horst Welding reserves the right at any time to change products, specifications or prices without prior notice.

Printed in Canada.

Index

Adapters	6	Telescopic Handler Bucket Extra High Volume	31
Euro Quick Fit Plate	7	Telescopic Handler Bucket High Volume	30
Euro Quick Fit Plate To Fit JD 600 Series	7	Telescopic Handler Bucket Standard	30
Euro Quick Fit Plate To Fit Universal Skidsteer	7	Bulk Bag Handler	19
Heavy Duty Universal Skidsteer Quick Fit Plate	9	Dirt Blades	42
Heavy Duty Universal Skidsteer Quick Fit Plate with Tilt	9	Heavy Duty 6-Way Dirt Blade	42
Industrial Carriers To Fit Tractor Loader Backhoe	7	Electical Wiring Kit (7, 8 or 14 Pin) -	
John Deere 600 Style Carrier	6	For OEM Connection	57
Regular Duty Euro / Global Skidsteer Quick Fit Plate	8	Optional OEM Connection Wire Kit	57
Regular Duty JD 400/500 Series Skidsteer Quick Fit Plate	8	Grapples	33
Regular Duty Universal Skidsteer Quick Fit Plate	8	Brush Grapple	41
Weld-on Kits (applicable to Price Codes)	6	Compact Brush Grapple	41
Weld-on Kits (NOT applicable to Price Codes)	6	Compact Scrap Grapple Bucket	33
Bale Grapples	15	Compact Utility Grapple	35
Round Bale Grapple	15	Debris Grapple Fork	33
Square Bale Squeeze	15	Extra Large Utility Grapple	35
Square/Round Bale Grapple	15	Heavy Duty Stone Fork & Regular Utility Grapple	38
Bale Spears	10	Large Utility Grapple	35
Double Prong Bale Spear	11	Light Duty Root Rake c/w Grapple	40
Double Prong Bale Spear c/w Guard	11	Low Profile Skidsteer Bucket & Skidsteer Grapple	37
Double Prong Bucket Spear	10	Manure Fork & Regular Utility Grapple	38
Double Three Point Hitch Spear	10	Manure Fork & Skidsteer Grapple	36
Five Prong Bale Spear w/ Rigid Frame	14	Regular Duty Stone Fork & Regular Utility Grapple	38
Four Prong Bale Spear c/w Adjustable Guard	13	Regular Duty Stone Fork & Skidsteer Grapple	36
Four Prong Bale Spear for Round Bales	13	Regular Utility Grapple	35
Four Prong Bale Spear w/ Rigid Frame	14	Root Rake c/w Grapple	40
Hyd Bale Claw	14	Scrap Grapple Bucket	33
Single Prong Bale Spear	11	Standard Front End Loader Bucket & Reg. Utility Grapple	39
Single Prong Bucket Spear	10	Standard Skidsteer Bucket & Regular Utility Grapple	39
Single Three Point Hitch Spear	10	Standard Skidsteer Bucket & Skidsteer Grapple	37
Three Prong Bale Spear	12	Stone Fork (Retainer Style Tine) with Split Grapple	34
Three Prong Bale Spear c/w Adjustable Guard	12	Loader Order Mounting Codes	62
Three Prong Bale Spear c/w Guard	12	Manure Forks	18
Boom Poles - Telescopic	19	Manure Fork (Cranked Kverneland Tine)	18
Boom Pole Telescopic (Hydraulic Activated)	19	Miscellaneous Attachments	44
Boom Pole Telescopic (Standard Activated)	19	Backhoe - Big Arm Skidsteer	45
Brooms - Hydraulic Rotary	42	Buckets - Big Arm Skidsteer	45
Dust Suppression Water Kit for Hydraulic Rotary Brooms	43	Concrete Funnel Bucket	46
Hydraulic Rotary Broom	43	Concrete Hopper Bucket	46
Hydraulic Rotary Pick-up Broom	42	Concrete Slab Lifter Bucket	46
Optional OEM Connection Wire Kit	43	Hydraulic Limb Saw	45
Buckets	20	Optional Thumb for Big Arm Backhoe	45
4 - In - 1 Bucket	31	PTO Adapter Three Point Hitch	44
Bucket Accessories	22	Three Point Hitch Adapter	44
Compact Low Profile Bucket	21	Three Point Hitch Weight Box	46
Compact Utility Bucket	20	Tilt Attachment	44
Extra High Volume Front End Loader Bucket	28	Trailer Hitch 2" Receiver	44
High Dump Bucket Compact	32	Order Form	91
High Dump Bucket High Volume	32	Pallet Forks	47
High Dump Bucket Standard	32	Bucket Pallet Fork	50
High Volume Front End Loader Bucket	26	Full Back Guard Option (Brick Guard)	48
High Volume Skidsteer Bucket	27	Heavy Duty Pallet Fork	47
High Volume Skidsteer Bucket - Long Lip	27	Light Duty Pallet Fork	47
High Volume Skidsteer Snow Bucket	29	Log Grapple	51
Low Profile Skidsteer Bucket	22	Pallet Fork Tine Extensions	51
Low Profile Skidsteer Bucket c/w Digging Teeth	23	Power Tilting Pallet Fork	49
Produce Skidsteer Bucket	29	Power Tine Pallet Fork	50
Standard Front End Loader Bucket	24	Rotating Pallet Fork	49
Standard Skidsteer Bucket	25	Side Shift Pallet Fork	50
Standard Skidsteer Bucket - Long Lip	25	Single Arm Log Grapple	51
Telescopic Handler and High Dump Bucket Accessories	30		

Rubber Scrapers53
 Heavy Duty Rubber Free Stall Scraper53
 Hydraulic Adjustable Rubber Scraper.54
 Rubber Feed Alley Scraper53

SB5QDM Quick Attach Snow Blade Mount60

Side Discharge Buckets.52
 Side Discharge Sand Bucket.53
 Side Discharge Sawdust Bucket.52
 Side Discharge Straw/Lime Bucket52
 Silage Facer - Bucket Mount.55
 Silage Facer - Frame Mount55

Silage Attachments56
 5000 Series Silage Blade - Front Wheel Assist Tractors57
 Bale Knife56
 Silage Grapple Bucket.56

Silage Blade - Articulated Tractors58
 6000 Series DBA Silage Blade & Frame59
 6000 Series DMA Undermounts59

Skidsteer Grader42
 Skidsteer Laser Grader42

Skidsteer Order Mounting Codes86

Stone Forks16
 Stone Fork (Cranked Kverneland Tine)16
 Stone Fork (Landscape with Power Rake)17
 Stone Fork (Retainer Style Tine)16

Stump Bucket.18
 Heavy Duty Stump Bucket.18

Tines5

Tooth Bars.20
 Compact Tooth Bar Bolt-on.20
 Tooth Bar Bolt-on.20

Tree Spade18
 Tree Spade18

Tines	UOM	Part #	Price
32" Conus II Straight Kverneland Tine Used In Bale Spear	ea	SDE32	\$129.00
39" Conus II Straight Kverneland Tine Used In Bale Spear	ea	SDE39	\$141.00
49" Conus II Straight Kverneland Tine Used In Bale Spear	ea	SDE49	\$165.00
36" Tine For HD09 & HD12 Pallet Fork	ea	HD0936	\$165.00
42" Tine For HD09 & HD12 Pallet Fork	ea	HD0942	\$177.00
48" Tine For HD09 & HD12 Pallet Fork	ea	HD0948	\$202.00
36" Tine For HD20 Pallet Fork	ea	HD236	\$226.00
42" Tine For HD20 Pallet Fork	ea	HD242	\$244.00
48" Tine For HD20 Pallet Fork	ea	HD248	\$251.00
42" Tine For HD42 Pallet Fork	ea	HD442	\$293.00
48" Tine For HD42 Pallet Fork	ea	HD448	\$324.00
42" Tine For HD55 Pallet Fork	ea	HD542	\$305.00
48" Tine For HD55 Pallet Fork	ea	HD548	\$336.00
54" Tine For HD55 Pallet Fork	ea	HD554	\$427.00
60" Tine For HD55 Pallet Fork	ea	HD560	\$556.00
72" Tine For HD55 Pallet Fork	ea	HD572	\$873.00
48" Tine For HD75 Pallet Fork	ea	HD748	\$739.00
54" Tine For HD75 Pallet Fork	ea	HD754	\$836.00
60" Tine For HD75 Pallet Fork	ea	HD760	\$1,044.00
72" Tine For HD75 Pallet Fork	ea	HD772	\$1,117.00
48" Tine For HD100 Pallet Fork	ea	HD1048	\$891.00
54" Tine For HD100 Pallet Fork	ea	HD1054	\$1,007.00
60" Tine For HD100 Pallet Fork	ea	HD1060	\$1,117.00
72" Tine For HD100 Pallet Fork	ea	HD1072	\$1,654.00

Adapters

Universal quick fit plates are designed to work with 65° skidsteer slope buckets. If converting a front end loader bucket to accept the adapter, the weld-on kit must be welded on at 65° to achieve the correct roll back and dump.

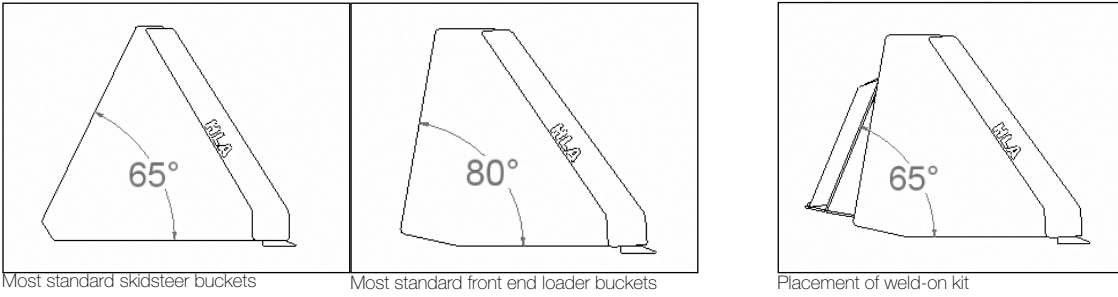

Weld-on kits are one or two piece, depending on loader mount configuration.



WOKBO500



WOKBO500K



WOKAO600



WOKJD640

Weld-on Kits (applicable to Price Codes)	UOM	Part #	Price Code			
			A	B	C	D
Weld-on Kit	ea	WOK	\$342.00	\$458.00	\$574.00	\$721.00

Weld-on Kits (NOT applicable to Price Codes)	UOM	Part #	Price
ALO QTach Weld-on Kit	ea	WOKAO600	\$226.00
ALO QTach Weld-on Kit Heavy Duty	ea	WOKAO600HD	\$434.00
Universal Skidsteer Weld-on Kit	ea	WOKBO500	\$226.00
Universal Skidsteer Weld-on Kit c/w 15° Kickout	ea	WOKBO500K	\$336.00
Universal Skidsteer Weld-on Kit Heavy Duty	ea	WOKBO500HD	\$488.00



ADJD640

- Compatible with classic John Deere 600 series quick attach buckets
- Approximate weight: 175 lbs

John Deere 600 Style Carrier	UOM	Part #	Price Code			
			A	B	C	D
John Deere 600 Style Carrier	ea	ADJD640	\$1,501.00	\$1,617.00	\$1,733.00	\$1,880.00

Build to spec adapters available: To accept choice of attach/to fit choice of loader.
Example: Attachment side JD 245/loader side JD 640. Call for pricing.
Many other configurations are available upon request.



TRIGGERLOCK

ADAO600

- **Now with TriggerLock - auto latching mechanism activated by attachment**
- Compatible to Euro tool carrier attachments such as the Alo / Quicke or John Deere Global
- Convenient single handle release with spring return on lock pins
- Approximate weight: 150 lbs
- 5500 lbs capacity

Euro Quick Fit Plate	UOM	Part #	Price Code			
			A	B	C	D
Euro Quick Fit Plate	ea	ADAO600	\$1,513.00	\$1,629.00	\$1,745.00	\$1,892.00
Optional Hydraulic Activated	ea	ADAO600HYD	\$934.00			
Alo/Euro Weld On Kit	ea	WOKAO600	\$226.00			

Popular configurations shown below



ADAO600BO500

- To pick up Euro tool carrier attachments such as the Alo / Quicke or John Deere Global with your skidsteer loader

Euro Quick Fit Plate To Fit Universal Skidsteer	UOM	Part #	Price
Euro Quick Fit Plate mounted to Skidsteer QT	ea	ADAO600BO500	\$1,513.00
Optional Hydraulic Activated	ea	ADAO600HYD	\$934.00
Alo/Euro Weld On Kit	ea	WOKAO600	\$226.00



ADAO600JD640

Euro Quick Fit Plate To Fit JD 600 Series	UOM	Part #	Price
Euro Quick Fit Plate mounted to JD 600 Series	ea	ADAO600JD640	\$1,745.00
Optional Hydraulic Activated	ea	ADAO600HYD	\$934.00
Alo/Euro Weld On Kit	ea	WOKAO600	\$226.00



ADJRBECA580L

- Fast change of industrial attachments
- (Manual lock or optional hydraulic lock)
- Horizontal locking pins
- Approximate weight: 325 lbs
- Common OEM configurations available

Industrial Carriers To Fit Tractor Loader Backhoe	UOM	Part #	Price Code			
			A	B	C	D
Case/New Holland TLB Style Carrier	ea	ADCAFFC	\$2,916.00	\$3,032.00	\$3,148.00	\$3,295.00
John Deere TLB Style Carrier	ea	ADJRBE	\$3,484.00	\$3,600.00	\$3,716.00	\$3,863.00
CAT IT Style Carrier	ea	ADCAIT24	\$3,484.00	\$3,600.00	\$3,716.00	\$3,863.00

Options for Industrial TLB Carriers	UOM	Part #	Price
Optional Hyd Lock for Above Adapters	ea	INDHYD	\$1,159.00
Industrial TLB Weld On Hooks To Fit Profile of Bucket Back (to fit above adapters)	set	WOKB	\$1,367.00

Adapters

Universal quick fit plates are designed to work with 65° skidsteer slope buckets. If converting a front end loader bucket to accept the adapter, the weld-on kit must be welded on at 65° to achieve the correct roll back and dump.

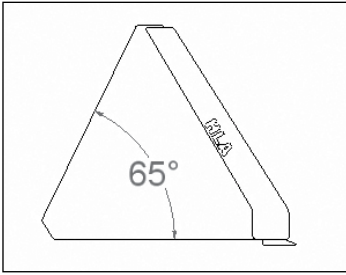

Most standard skidsteer buckets

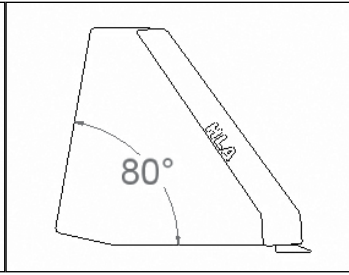

Most standard front end loader buckets

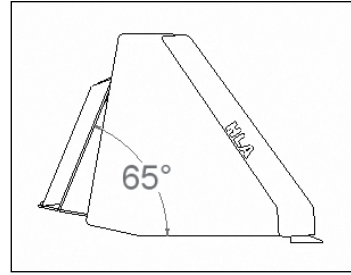

Placement of weld-on kit

ADAPTERS



BOQF10

- 3500 lbs capacity
- Compatible to universal skidsteer attachments
- Spring-loaded over-centre lever lock
- Ideal for compact to mid-size loaders
- Approximate weight: 135 lbs

Regular Duty Universal Skidsteer Quick Fit Plate	UOM	Part #	Price Code			
			A	B	C	D
Regular Duty Universal Quick Fit Plate	ea	BOQF10	\$1,385.00	\$1,501.00		
Optional Hydraulic Activated	ea	BOQF10HYD	\$714.00			
Universal Skidsteer Weld-on Kit	ea	WOKBO500	\$226.00			

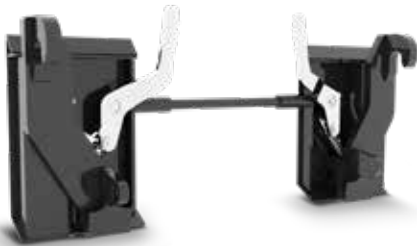

BOQF10A0600

Regular Duty Euro / Global Skidsteer Quick Fit Plate	UOM	Part #	Price
Regular Duty Euro / Global Quick Fit Plate	ea	BOQF10A0600	\$1,385.00
Optional Hydraulic Activated	ea	BOQF10HYD	\$714.00
Universal Skidsteer Weld-on Kit	ea	WOKBO500	\$226.00



BOQF10JD440540

Regular Duty JD 400/500 Series Skidsteer Quick Fit Plate	UOM	Part #	Price
Regular Duty JD 400/500 Series Quick Fit Plate	ea	BOQF10JD440540	\$1,385.00
Optional Hydraulic Activated	ea	BOQF10HYD	\$714.00
Universal Skidsteer Weld-on Kit	ea	WOKBO500	\$226.00



BOQF10H

- 5500 lbs capacity
- Same features as regular duty
- Universal quick fit plate
- Ideal for mid-size to industrial loaders
- Approximate weight: 250 lbs

Heavy Duty Universal Skidsteer Quick Fit Plate	UOM	Part #	Price Code			
			A	B	C	D
Heavy Duty Universal Quick Fit Plate	ea	BOQF10H	\$1,721.00	\$1,837.00	\$1,953.00	\$2,100.00
Optional Hydraulic Activated	ea	BOQF10HYD	\$714.00			
Universal Skidsteer Weld-on Kit	ea	WOKBO500	\$226.00			
Optional 90" Hose Kit c/w Flat Faced Couplers	ea	HK90	\$324.00			



BOQF10H3PHT

- Utilize skidsteer attachments on 3PH
- Fits 3PH Cat 1 and 2
- 5500 lbs capacity
- Approximate weight: 500 lbs
- Comes with 4" X 8" stroke cylinder
- Hoses not included

Heavy Duty Universal Skidsteer Quick Fit Plate with Tilt	UOM	Part #	Price
Heavy Duty Universal Quick Fit Plate with Tilt	ea	BOQF10H3PHT	\$4,490.00
Universal Skidsteer Weld-on Kit	ea	WOKBO500	\$226.00

Bale Spears

BALE SPEARS



SE3PH39

- Reese receiver/ball hitch (Ball hitch not included)
- Fits both CAT I & II
- Kverneland tine
- 2 stabilizer tines
- 2000 lbs capacity @ 24" L.C.
- Available with 39" or 49" tine
- Approximate weight: 87 lbs

Single Three Point Hitch Spear

	UOM	Part #	Price
39" Tine (34" Useable Length)	ea	SE3PH39	\$513.00
49" Tine (44" Useable Length)	ea	SE3PH49	\$537.00

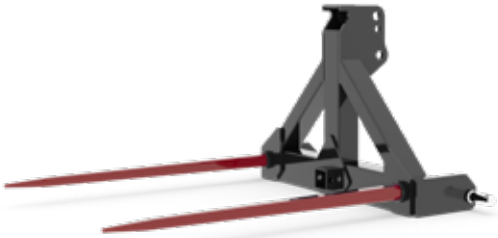

DE3PH39

- Reese receiver/ball hitch (Ball hitch not included)
- Fits both CAT I & II
- Kverneland tine
- Available with 39" or 49" tines
- Approximate weight: 117 lbs
- 2000 lbs capacity @ 24" L.C.

Double Three Point Hitch Spear

	UOM	Part #	Price
39" Tine (34" Useable Length)	ea	DE3PH39	\$708.00
49" Tine (44" Useable Length)	ea	DE3PH49	\$757.00



BS4039

- Kverneland tine
- 2000 lbs capacity @ 24" L.C.
- Adaptable to most buckets
- No tools or bolts needed
- Comes with chain & tightener
- Approximate weight: 86 lbs

Single Prong Bucket Spear

	UOM	Part #	Price
39" Tine (34" Useable Length)	ea	BS4039	\$647.00



BSD4039

- Kverneland tines @ 30" spacing
- Same as above but with extra tine to handle large square bales
- Approximate weight: 112 lbs
- 2000 lbs capacity @ 24" L.C.

Double Prong Bucket Spear

	UOM	Part #	Price
39" Tine (34" Useable Length)	ea	BSD4039	\$861.00



SE5039

- Kverneland tine
- Easy stabbing & removal
- 2000 lbs capacity @ 24" L.C.
- Available with 39" or 49" tine
- Two stabilizer tines
- Approximate weight: 165 lbs
- Frame width 50"

Single Prong Bale Spear	UOM	Part #	Price Code			
			A	B	C	D
39" Tine (34" Useable Length)	ea	SE5039	\$684.00	\$800.00	\$916.00	\$1,063.00
49" Tine (44" Useable Length)	ea	SE5049	\$708.00	\$824.00	\$940.00	\$1,087.00



DE5039

- Kverneland tines @ 30" spacing
- Works well for either round bales or large square bales
- Not to be used for carrying 2 bales stacked on top of each other
- Available with 32", 39" or 49" tines
- Approximate weight: 185 lbs
- 4000 lbs capacity @ 24" L.C.
- Frame width 50"

Double Prong Bale Spear	UOM	Part #	Price Code			
			A	B	C	D
32" Tine (27" Useable Length)	ea	DE5032	\$854.00	\$970.00	\$1,086.00	\$1,233.00
39" Tine (34" Useable Length)	ea	DE5039	\$879.00	\$995.00	\$1,111.00	\$1,258.00
49" Tine (44" Useable Length)	ea	DE5049	\$928.00	\$1,044.00	\$1,160.00	\$1,307.00



DE5539

- Same as above except with bolt-on guard
- Added protection for handling large square bales 2 high
- **Safety foot for roll over protection while in storage position**
- 50" overall height
- Available with 32", 39" or 49" tines
- Approximate weight: 305 lbs
- 4000 lbs capacity @ 24" L.C.
- Frame width 50"

Double Prong Bale Spear c/w Guard	UOM	Part #	Price Code			
			A	B	C	D
32" Tine c/w Guard (27" Useable Length)	ea	DE5532	\$1,227.00	\$1,343.00	\$1,459.00	\$1,606.00
39" Tine c/w Guard (34" Useable Length)	ea	DE5539	\$1,251.00	\$1,367.00	\$1,483.00	\$1,630.00
49" Tine c/w Guard (44" Useable Length)	ea	DE5549	\$1,300.00	\$1,416.00	\$1,532.00	\$1,679.00
Bolt On Guard Only	ea	GU	\$373.00			

BALE SPEARS

Bale Spears



- Kverneland tines @ 23" spacing
- Made to handle large 4' x 4' x 8' square bales
- Not to be used for carrying 2 bales stacked on top of each other
- Available with 32", 39" or 49" tines
- Frame width 50"
- Approximate weight: 210 lbs
- 5000 lbs capacity @ 24" L.C.

TE5039

Three Prong Bale Spear	UOM	Part #	Price Code			
			A	B	C	D
32" Tine (27" Useable Length)	ea	TE5032	\$1,056.00	\$1,172.00	\$1,288.00	\$1,435.00
39" Tine (34" Useable Length)	ea	TE5039	\$1,092.00	\$1,208.00	\$1,324.00	\$1,471.00
49" Tine (44" Useable Length)	ea	TE5049	\$1,166.00	\$1,282.00	\$1,398.00	\$1,545.00



- Same as above except with bolt-on guard
- Added protection for handling large square bales 2 high
- **Safety foot for roll over protection while in storage position**
- 50" overall height
- Available with 32", 39" or 49" tines
- Frame width 50"
- Approximate weight: 330 lbs
- 5000 lbs capacity @ 24" L.C.

TE5532

Three Prong Bale Spear c/w Guard	UOM	Part #	Price Code			
			A	B	C	D
32" Tine c/w Guard (27" Useable Length)	ea	TE5532	\$1,428.00	\$1,544.00	\$1,660.00	\$1,807.00
39" Tine c/w Guard (34" Useable Length)	ea	TE5539	\$1,464.00	\$1,580.00	\$1,696.00	\$1,843.00
49" Tine c/w Guard (44" Useable Length)	ea	TE5549	\$1,538.00	\$1,654.00	\$1,770.00	\$1,917.00
Bolt On Guard Only	ea	GU	\$373.00			



- 50" high frame with adjustable guard posts for safe handling of large square bales up to 3 high
- **Safety foot for roll over protection while in storage position**
- Extended height of 84"
- Retracted height of 50"
- Available with 32", 39" or 49" tines
- Frame width 56"
- Approximate weight: 365 lbs
- 6000 lbs capacity @ 24" L.C.
- Kverneland tines @ 23" spacing

TE55039

Three Prong Bale Spear c/w Adjustable Guard	UOM	Part #	Price Code			
			A	B	C	D
32" Tine c/w Adj. Guard Posts (27" Useable Length)	ea	TE55032	\$1,586.00	\$1,702.00	\$1,818.00	\$1,965.00
39" Tine c/w Adj. Guard Posts (34" Useable Length)	ea	TE55039	\$1,623.00	\$1,739.00	\$1,855.00	\$2,002.00
49" Tine c/w Adj. Guard Posts (44" Useable Length)	ea	TE55049	\$1,696.00	\$1,812.00	\$1,928.00	\$2,075.00



FE55039

- Designed specifically for carrying large 4' x 4' x 8' square bales, 2 high
- **Safety foot for roll over protection while in storage position**
- Available with 39" or 49" tines
- Extended height of 84"
- Retracted height of 50"
- Frame width 66"
- Approximate weight: 415 lbs
- 6000 lbs capacity @ 24" L.C.
- Kverneland tines @ 18-3/4" spacing

Four Prong Bale Spear c/w Adjustable Guard	UOM	Part #	Price Code			
			A	B	C	D
39" Tine c/w Guard (34" Useable Length)	ea	FE55039	\$1,830.00	\$1,946.00	\$2,062.00	\$2,209.00
49" Tine c/w Guard (44" Useable Length)	ea	FE55049	\$1,928.00	\$2,044.00	\$2,160.00	\$2,307.00

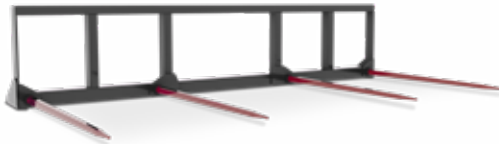

FE10039

- Designed specifically for carrying 2 round bales
- Can carry 2 round bales up to 6' diameter
- Frame width 100"
- Approximate weight 340 lbs
- 4000 lbs capacity @ 24" L.C.
- Kverneland tines, each side @ 29" spacing

Four Prong Bale Spear for Round Bales	UOM	Part #	Price Code			
			A	B	C	D
39" Tine (34" Useable Length)	ea	FE10039	\$1,867.00	\$1,983.00	\$2,099.00	\$2,246.00
49" Tine (44" Useable Length)	ea	FE10049	\$1,965.00	\$2,081.00	\$2,197.00	\$2,344.00

BALE SPEARS

Bale Spears

BALE SPEARS



FE7839

- Ideal for handling stacked large square bales
- 80" overall height
- Safety foot for roll over protection while in storage position
- Frame width 72"
- Conus 1 bushings in upper frame for optional stabilizers
- 6000 lbs capacity @ 24" L.C.
- Kverneland tines @ 21-5/8" spacing
- Approximate weight 580 lbs

Four Prong Bale Spear w/ Rigid Frame	UOM	Part #	Price Code			
			A	B	C	D
39" Tine (34" Useable Length)	ea	FE7839	\$1,977.00	\$2,093.00	\$2,209.00	\$2,356.00
49" Tine (44" Useable Length)	ea	FE7849	\$2,074.00	\$2,190.00	\$2,306.00	\$2,453.00



QE57239

- Ideal for handling stacked large square bales
- 74" overall height
- Safety foot for roll over protection while in storage position
- Frame width 72"
- 8000 lbs capacity @ 24" L.C.
- Kverneland tines @ 17" spacing
- Approximate weight 545 lbs

Five Prong Bale Spear w/ Rigid Frame	UOM	Part #	Price Code			
			A	B	C	D
39" Tine (34" Useable Length)	ea	QE57239	\$2,367.00	\$2,483.00	\$2,599.00	\$2,746.00
49" Tine (44" Useable Length)	ea	QE57249	\$2,489.00	\$2,605.00	\$2,721.00	\$2,868.00



BC647232

- Ideal for handling stacked large square bales
- 12 hydraulic claws rotate into stack for secure handling
- 72" overall height
- Frame width 64"
- 6000 lbs capacity
- 3 Kverneland tines @ 23" spacing
- Approximate weight 1090 lbs

Hyd Bale Claw	UOM	Part #	Price Code			
			A	B	C	D
32" Tine (27" Useable Length)	ea	BC647232	\$6,222.00	\$6,338.00	\$6,454.00	\$6,601.00
Optional 90" Hose Kit c/w Flat Faced Couplers	ea	HK90	\$324.00			
Optional Spring Hose Mount Kit	ea	SHMK	\$147.00			



BG4000

- Designed for gentle handling of heavy wrapped silage bales
- Lockable arms, one arm can be locked in a fixed position using pins so that all movement occurs in the other arm. Useful for stacking.
- Includes standard 8" stroke implement cylinder
- Works with up to 5" diameter bales
- Approximate weight: 570 lbs
- 1800 lbs capacity

Round Bale Grapple	UOM	Part #	Price Code			
			A	B	C	D
Round Bale Grapple	ea	BG4000	\$3,136.00	\$3,252.00	\$3,368.00	\$3,515.00
Optional 90" Hose Kit c/w Flat Faced Couplers	ea	HK90	\$324.00			
Optional Spring Hose Mount Kit	ea	SHMK	\$147.00			

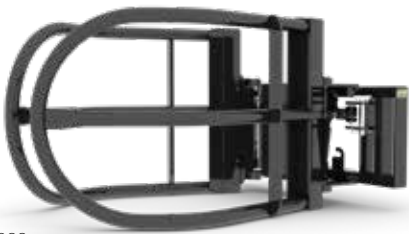

BG6000

- Same specs and design as round bale grapple with arms to accept square bales 4 - 6 ft long and round bales 5-6 ft diameter
- Opens up to 84"
- Approximate weight: 590 lbs
- 2000 lbs capacity
- Lockable arms, one arm can be locked in a fixed position using pins so that all movement occurs in the other arm. Useful for stacking.

Square/Round Bale Grapple	UOM	Part #	Price Code			
			A	B	C	D
Square/Round Bale Grapple	ea	BG6000	\$3,538.00	\$3,654.00	\$3,770.00	\$3,917.00
Optional 90" Hose Kit c/w Flat Faced Couplers	ea	HK90	\$324.00			
Optional Spring Hose Mount Kit	ea	SHMK	\$147.00			



BG7000

- 86" extended – 30" retracted
- Arms are 50" long, 20" tall
- Dual 2 1/2" x 28" stroke cylinder
- Slim brace arm design allows for tight stacking of bales
- Approximate weight: 810 lbs
- 3000 lbs capacity

Square Bale Squeeze	UOM	Part #	Price Code			
			A	B	C	D
Square Bale Squeeze	ea	BG7000	\$5,350.00	\$5,466.00	\$5,582.00	\$5,729.00
Optional 90" Hose Kit c/w Flat Faced Couplers	ea	HK90	\$324.00			
Optional Spring Hose Mount Kit	ea	SHMK	\$147.00			

BALE GRAPPLERS

Stone Forks



- 39" Conus II cranked Kverneland tines (32" useable length)
- Tines installed on 4" centres
- Ruggedly built
- Heavy duty back guard with 3 lb expanded metal grating
- 25.5" overall height

SF96

Stone Fork (Cranked Kverneland Tine)	Weight	UOM	Part #	Price Code			
	in lbs			A	B	C	D
60" Stone Fork 18-Cranked Tines	610	ea	SF60	\$4,832.00	\$4,948.00	\$5,064.00	\$5,211.00
72" Stone Fork 21-Cranked Tines	690	ea	SF72	\$5,375.00	\$5,491.00	\$5,607.00	\$5,754.00
84" Stone Fork 24-Cranked Tines	770	ea	SF84	\$6,009.00	\$6,125.00	\$6,241.00	\$6,388.00
96" Stone Fork 27-Cranked Tines	850	ea	SF96	\$6,662.00	\$6,778.00	\$6,894.00	\$7,041.00
108" Stone Fork 30-Cranked Tines	935	ea	SF108	\$7,473.00	\$7,589.00	\$7,705.00	\$7,852.00
120" Stone Fork 34-Cranked Tines	1035	ea	SF120	\$8,473.00	\$8,589.00	\$8,705.00	\$8,852.00



- 1" Shaft diameter
- 2½" spacing between tines
- Points are 5/8" thick, 400 Brinell high strength steel
- 23" high
- 35" deep
- 2000 lbs capacity

SFRC48

Stone Fork (Retainer Style Tine)	Weight	UOM	Part #	Price Code			
	in lbs			A	B	C	D
Compact Duty - up to 2000 LB Capacity							
48" Stone Fork Retainer Tine Compact Duty	410	ea	SFRC48	\$2,056.00	\$2,172.00	\$2,288.00	\$2,435.00
55" Stone Fork Retainer Tine Compact Duty	450	ea	SFRC55	\$2,245.00	\$2,361.00	\$2,477.00	\$2,624.00
62" Stone Fork Retainer Tine Compact Duty	490	ea	SFRC62	\$2,392.00	\$2,508.00	\$2,624.00	\$2,771.00
70" Stone Fork Retainer Tine Compact Duty	530	ea	SFRC70	\$2,526.00	\$2,642.00	\$2,758.00	\$2,905.00



- **Regular duty**
- 1¼" shaft diameter
- 2½" spacing between tines
- Points are 5/8" thick, 400 Brinell high strength steel
- 23" high
- 40" deep
- 5500 lbs capacity

SFR70

Stone Fork (Retainer Style Tine)	Weight	UOM	Part #	Price Code			
	in lbs			A	B	C	D
Regular Duty - up to 5500 LB Capacity							
55" Stone Fork Retainer Tine Regular Duty	570	ea	SFR55	\$2,440.00	\$2,556.00	\$2,672.00	\$2,819.00
62" Stone Fork Retainer Tine Regular Duty	630	ea	SFR62	\$2,660.00	\$2,776.00	\$2,892.00	\$3,039.00
70" Stone Fork Retainer Tine Regular Duty	690	ea	SFR70	\$2,910.00	\$3,026.00	\$3,142.00	\$3,289.00
77" Stone Fork Retainer Tine Regular Duty	745	ea	SFR77	\$3,118.00	\$3,234.00	\$3,350.00	\$3,497.00
84" Stone Fork Retainer Tine Regular Duty	805	ea	SFR84	\$3,374.00	\$3,490.00	\$3,606.00	\$3,753.00
92" Stone Fork Retainer Tine Regular Duty	865	ea	SFR92	\$3,593.00	\$3,709.00	\$3,825.00	\$3,972.00



SFRH77

- Heavy duty
- 1¼" shaft diameter
- 2¾" spacing between tines
- Points are ¾" thick, 400 Brinell high strength steel
- 31" high
- 50" deep
- 9500 lbs capacity

Stone Fork (Retainer Style Tine)	Weight	UOM	Part #	Price Code			
				A	B	C	D
Heavy Duty - up to 9500 LB Capacity	in lbs						
77" Stone Fork Retainer Tine Heavy Duty	1325	ea	SFRH77	\$4,179.00	\$4,295.00	\$4,411.00	\$4,558.00
85" Stone Fork Retainer Tine Heavy Duty	1455	ea	SFRH85	\$4,478.00	\$4,594.00	\$4,710.00	\$4,857.00
90" Stone Fork Retainer Tine Heavy Duty	1520	ea	SFRH90	\$4,746.00	\$4,862.00	\$4,978.00	\$5,125.00
94" Stone Fork Retainer Tine Heavy Duty	1590	ea	SFRH94	\$5,033.00	\$5,149.00	\$5,265.00	\$5,412.00
98" Stone Fork Retainer Tine Heavy Duty	1655	ea	SFRH98	\$5,314.00	\$5,430.00	\$5,546.00	\$5,693.00
103" Stone Fork Retainer Tine Heavy Duty	1720	ea	SFRH103	\$5,600.00	\$5,716.00	\$5,832.00	\$5,979.00
108" Stone Fork Retainer Tine Heavy Duty	1785	ea	SFRH108	\$5,881.00	\$5,997.00	\$6,113.00	\$6,260.00



SFRL72

- ¾" shaft diameter
- 1¼" spacing between tines
- Points are ½" thick, 400 Brinell high strength steel
- 32" high
- 35½" deep
- Ideal for picking up both windrows of stones and loose stones in soil being prepared for seed beds

Stone Fork (Landscape with Power Rake)	Weight	UOM	Part #	Price Code			
				A	B	C	D
72" Stone Fork (Landscape) w/ Power Rake	1200	ea	SFRL72	\$11,353.00	\$11,469.00	\$11,585.00	\$11,732.00
84" Stone Fork (Landscape) w/ Power Rake	1330	ea	SFRL84	\$11,609.00	\$11,725.00	\$11,841.00	\$11,988.00
96" Stone Fork (Landscape) w/ Power Rake	1465	ea	SFRL96	\$11,859.00	\$11,975.00	\$12,091.00	\$12,238.00
108" Stone Fork (Landscape) w/ Power Rake	1600	ea	SFRL108	\$12,115.00	\$12,231.00	\$12,347.00	\$12,494.00
Optional 90" Hose Kit c/w Flat Faced Couplers		ea	HK90	\$324.00			
Optional Spring Hose Mount Kit		ea	SHMK	\$147.00			
For complete price add Wire Kit price to SFRL of choice							

Wire Kit for Stone Fork (Landscape with Power Rake) - Must choose 1	Part #	Price
Complete Single Diverter Wire Kit w/ 2 Way Switch	WKDV1	\$568.00
OEM Connection Wire Kit (See Info on Page 57)		

STONE FORKS

Tree Spade

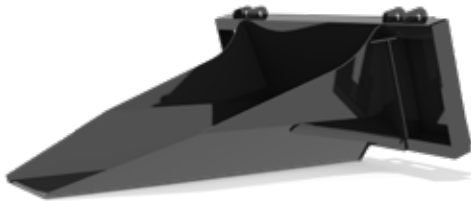

TS48

- Ideal for transplanting trees and shrubbery
- Scoop made from ¼" material
- 33" wide
- 48" deep

Tree Spade	Weight	UOM	Part #	Price Code			
	in lbs			A	B	C	D
Tree Spade (For Skidsteers Only)	365	ea	TS48	\$2,422.00			

Stump Bucket



STM

- Designed to rip through roots and remove stumps
- Works well to dig out boulders and dig shallow trenches
- Comes with three replaceable digging teeth
- Serrated side edges
- Optional hydraulic grapple for increased versatility

Heavy Duty Stump Bucket	Weight	UOM	Part #	Price Code			
	in lbs			A	B	C	D
Heavy Duty Stump Bucket	435	ea	STM	\$2,648.00	\$2,764.00	\$2,880.00	\$3,027.00
Heavy Duty Stump Bucket with Grapple	600	ea	STMG	\$4,911.00	\$5,027.00	\$5,143.00	\$5,290.00

Manure Forks



MFE66

- LDFE 32" Conus I cranked Kverneland tines (28" useable length)
- MFE 35" Conus I cranked Kverneland tines (31" useable length)
- Superior penetration
- Flat top acts as level indicator

Manure Fork (Cranked Kverneland Tine)	Tine	Weight	UOM	Part #	Price Code			
	Centres	in lbs			A	B	C	D
42" Light Duty Manure Fork 6-Cranked Tines	7¾"	245	ea	LDFE42	\$1,098.00	\$1,214.00		
48" Light Duty Manure Fork 7-Cranked Tines	7½"	270	ea	LDFE48	\$1,190.00	\$1,306.00		
48" Manure Fork 7-Cranked Tines	7½"	350	ea	MFE48	\$1,403.00	\$1,519.00	\$1,635.00	\$1,782.00
54" Manure Fork 7-Cranked Tines	8½"	370	ea	MFE54	\$1,501.00	\$1,617.00	\$1,733.00	\$1,880.00
60" Manure Fork 8-Cranked Tines	8¼"	405	ea	MFE60	\$1,599.00	\$1,715.00	\$1,831.00	\$1,978.00
66" Manure Fork 9-Cranked Tines	8"	435	ea	MFE66	\$1,745.00	\$1,861.00	\$1,977.00	\$2,124.00
72" Manure Fork 9-Cranked Tines	8 5/8"	455	ea	MFE72	\$1,849.00	\$1,965.00	\$2,081.00	\$2,228.00
84" Manure Fork 11-Cranked Tines	8 1/8"	520	ea	MFE84	\$2,068.00	\$2,184.00	\$2,300.00	\$2,447.00
96" Manure Fork 13-Cranked Tines	7 7/8"	590	ea	MFE96	\$2,532.00	\$2,648.00	\$2,764.00	\$2,911.00

Boom Poles - Telescopic



BP120

- 6 ft main boom with a 4 ft telescopic boom
- 3000 lbs capacity closed / 1500 lbs capacity extended
- Five position telescopic boom
- Pintle end hook with spring-loaded locking arm & pin
- Approximate weight: 370 lbs

Boom Pole Telescopic (Standard Activated)	Open	Closed	UOM	Part #	Price Code			
					A	B	C	D
Telescopic Boom Pole - Standard	10 ft	6 ft	ea	BP120	\$1,843.00	\$1,959.00	\$2,075.00	\$2,222.00



BPHA240

- 13½ ft main boom with hydraulically controlled 6½ ft telescopic boom
- 3000 lbs capacity closed / 1500 lbs capacity extended
- Pintle end hook with spring-loaded locking arm & pin
- Approximate weight: 775 lbs

Boom Pole Telescopic (Hydraulic Activated)	Open	Closed	UOM	Part #	Price Code			
					A	B	C	D
Telescopic Boom Pole - Hydraulic	20 ft	13½ ft	ea	BPHA240	\$3,435.00	\$3,551.00	\$3,667.00	\$3,814.00
Optional 90" Hose Kit c/w Flat Faced Couplers			ea	HK90	\$324.00			
Optional Spring Hose Mount Kit			ea	SHMK	\$147.00			

BOOM POLES - TELESCOPIC / BULK BAG HANDLER

Bulk Bag Handler



BBH5

- Designed to move bulk tote bags safely
- Fits most skidsteers and loaders
- 5000 lbs capacity

Bulk Bag Handler	Weight	UOM	Part #	Price Code			
	in lbs			A	B	C	D
Bulk Bag Handler	440	ea	BBH5	\$4,380.00	\$4,496.00	\$4,612.00	\$4,759.00

Tooth Bars



TB72

- Designed to fit select HLA bucket models MB, MBHD, MBHV, MBHVHD, MBHVX, MBHVXHD, SB, SBHD, SBLP, SBLPHD, SBHV, SBHVHD
- Easy to remove replaceable teeth

Tooth Bar Bolt-on	Length	Fits Buckets with Inside Measurement of	Weight	# of Teeth	UOM	Part #	Price
			in lbs				
59½" Wide Bolt On Tooth Bar	59.5"	60"	70	6	ea	TB60	\$659.00
65½" Wide Bolt On Tooth Bar	65.5"	66"	77	7	ea	TB66	\$720.00
71½" Wide Bolt On Tooth Bar	71.5"	72"	80	8	ea	TB72	\$751.00
77½" Wide Bolt On Tooth Bar	77.5"	78"	89	8	ea	TB78	\$763.00
83½" Wide Bolt On Tooth Bar	83.5"	84"	98	9	ea	TB84	\$781.00



TBC60

- Designed to fit HLA compact bucket models MBC, SBC, SBC1828, SBC2122
- Easy to remove replaceable teeth

Compact Tooth Bar Bolt-on	Length	Fits Buckets with Inside Measurement of	Weight	# of Teeth	UOM	Part #	Price
			in lbs				
47 3/4" Wide Bolt On Compact Tooth Bar	47.75"	48"	54	5	ea	TBC48	\$623.00
53 3/4" Wide Bolt On Compact Tooth Bar	53.75"	54"	63	6	ea	TBC54	\$641.00
59 3/4" Wide Bolt On Compact Tooth Bar	59.75"	60"	67	6	ea	TBC60	\$659.00
65 3/4" Wide Bolt On Compact Tooth Bar	65.75"	66"	74	7	ea	TBC66	\$720.00
71 3/4" Wide Bolt On Compact Tooth Bar	71.75"	72"	83	8	ea	TBC72	\$751.00

Buckets



MBC60

- 1/8" material, 3/16" end plates
- ½ X 4 bevelled cutting edge
- 19" deep, 19" high
- 80° slope on back of bucket
- Reinforced round back and end plates for strength, easy filling & clean out
- Flat top acts as level indicator
- Drilled for standard bolt on cutting edge

Add 1" to Inside Width column to calculate Outside Width of bucket

Compact Utility Bucket	Inside Width	Struck Cap - Level	SAE Cap - Heaped	Weight	UOM	Part #	Price Code			
							A	B	C	D
Front End Loader		cu ft	cu ft	in lbs						
36" Compact Utility Bucket	36"	4.5	5.5	205	ea	MBC36	\$848.00	\$964.00	\$1,080.00	
42" Compact Utility Bucket	42"	5.2	6.6	215	ea	MBC42	\$861.00	\$977.00	\$1,093.00	
48" Compact Utility Bucket	48"	6.0	7.5	230	ea	MBC48	\$879.00	\$995.00	\$1,111.00	
54" Compact Utility Bucket	54"	6.7	8.5	245	ea	MBC54	\$940.00	\$1,056.00	\$1,172.00	
60" Compact Utility Bucket	60"	7.5	9.5	260	ea	MBC60	\$1,001.00	\$1,117.00	\$1,233.00	
66" Compact Utility Bucket	66"	8.2	10.5	270	ea	MBC66	\$1,050.00	\$1,166.00	\$1,282.00	
72" Compact Utility Bucket	72"	9.0	11.5	290	ea	MBC72	\$1,123.00	\$1,239.00	\$1,355.00	



- 1/8" material, 3/16" end plates
- 1/2 X 4 bevelled cutting edge
- 21" deep, 18" high
- 65° slope on back of bucket
- Reinforced round back and end plates for strength, easy filling & clean out
- Flat top acts as level indicator
- Drilled for standard bolt on cutting edge

SBC60

Add 1" to Inside Width column to calculate Outside Width of bucket

Compact Utility Bucket	Inside Width	Struck Cap - Level	SAE Cap - Heaped	Weight	UOM	Part #	Price Code			
							A	B	C	D
Skidsteer		cu ft	cu ft	in lbs						
36" Compact Utility Bucket	36"	4.3	5.3	210	ea	SBC36	\$848.00	\$964.00	\$1,080.00	
42" Compact Utility Bucket	42"	4.9	6.1	230	ea	SBC42	\$861.00	\$977.00	\$1,093.00	
48" Compact Utility Bucket	48"	5.7	7.2	245	ea	SBC48	\$879.00	\$995.00	\$1,111.00	
54" Compact Utility Bucket	54"	6.4	8.1	260	ea	SBC54	\$940.00	\$1,056.00	\$1,172.00	
60" Compact Utility Bucket	60"	7.1	9.0	275	ea	SBC60	\$1,001.00	\$1,117.00	\$1,233.00	
66" Compact Utility Bucket	66"	7.8	10.0	285	ea	SBC66	\$1,050.00	\$1,166.00	\$1,282.00	
72" Compact Utility Bucket	72"	8.5	10.9	310	ea	SBC72	\$1,123.00	\$1,239.00	\$1,355.00	



- 1/8" material, 3/16" end plates
- 1/2 X 4 bevelled cutting edge
- 22" deep, 21" high
- 70° slope on back of bucket
- Reinforced round back and end plates for strength, easy filling & clean out
- Flat top acts as level indicator
- Drilled for standard bolt on cutting edge

MBC662122

Compact Utility Bucket	Inside Width	Struck Cap - Level	SAE Cap - Heaped	Weight	UOM	Part #	Price Code			
							A	B	C	D
Front End Loader		cu ft	cu ft	in lbs						
48" Compact Utility Bucket	48"	8.0	9.8	230	ea	MBC482122	\$1,025.00	\$1,141.00	\$1,257.00	
54" Compact Utility Bucket	54"	9.0	11.1	245	ea	MBC542122	\$1,086.00	\$1,202.00	\$1,318.00	
60" Compact Utility Bucket	60"	10.0	12.3	260	ea	MBC602122	\$1,147.00	\$1,263.00	\$1,379.00	
66" Compact Utility Bucket	66"	11.0	13.6	275	ea	MBC662122	\$1,196.00	\$1,312.00	\$1,428.00	
72" Compact Utility Bucket	72"	12.0	14.9	290	ea	MBC722122	\$1,269.00	\$1,385.00	\$1,501.00	



- 1/8" material, 3/16" end plates
- 1/2 X 4 bevelled cutting edge
- 26" deep, 17" high
- 65° slope on back of bucket
- Reinforced round back and end plates for strength, easy filling & clean out
- Longer base enables operator to see cutting edge of bucket
- Flat top acts as level indicator
- Drilled for standard bolt on cutting edge

SBC481828

Compact Low Profile Bucket	Inside Width	Struck Cap - Level	SAE Cap - Heaped	Weight	UOM	Part #	Price Code			
							A	B	C	D
Skidsteer		cu ft	cu ft	in lbs						
36" Compact Low Profile Skidsteer Bucket	36"	4.9	6.0	180	ea	SBC361828	\$1,098.00	\$1,214.00	\$1,330.00	
42" Compact Low Profile Skidsteer Bucket	42"	5.6	7.1	220	ea	SBC421828	\$1,111.00	\$1,227.00	\$1,343.00	
48" Compact Low Profile Skidsteer Bucket	48"	6.5	8.2	240	ea	SBC481828	\$1,129.00	\$1,245.00	\$1,361.00	
54" Compact Low Profile Skidsteer Bucket	54"	7.3	9.2	255	ea	SBC541828	\$1,190.00	\$1,306.00	\$1,422.00	
60" Compact Low Profile Skidsteer Bucket	60"	8.1	10.3	270	ea	SBC601828	\$1,245.00	\$1,361.00	\$1,477.00	

Buckets



SBLP66

Regular duty

- 3/16" Material, 1/4" end plates
- 3/4 X 4 bevelled cutting edge
- Reinforced top lip
- 32" deep, 19" high
- Lower back and longer base enables operator to see cutting edge of bucket
- Drilled for standard bolt on cutting edge
- Tapered end plates are self-cleaning and reduces material build-up

Heavy duty

- 1/4" Material, 1/4" end plates
- 3/4 X 6 bevelled cutting edge
- Reinforced top lip
- 34" deep, 19" high
- Lower back and longer base enables operator to see cutting edge of bucket
- Drilled for standard bolt on cutting edge

Add 2" to Inside Width column to calculate Outside Width of bucket

Low Profile Skidsteer Bucket	Inside Width	Struck Cap - Level	SAE Cap - Heaped	Weight	Part #	Price Code			
						A	B	C	D
Regular Duty		cu ft	cu ft	in lbs					
48" RD Low Pro Skidsteer Bucket	48"	8.3	11.3	395	SBLP48	\$1,349.00	\$1,465.00		
54" RD Low Pro Skidsteer Bucket	54"	9.4	12.8	420	SBLP54	\$1,397.00	\$1,513.00		
60" RD Low Pro Skidsteer Bucket	60"	10.4	14.3	445	SBLP60	\$1,434.00	\$1,550.00		
66" RD Low Pro Skidsteer Bucket	66"	11.4	16.1	470	SBLP66	\$1,501.00	\$1,617.00		
72" RD Low Pro Skidsteer Bucket	72"	12.5	17.4	500	SBLP72	\$1,550.00	\$1,666.00		
78" RD Low Pro Skidsteer Bucket	78"	13.5	18.9	535	SBLP78	\$1,641.00	\$1,757.00		
84" RD Low Pro Skidsteer Bucket	84"	14.6	20.4	565	SBLP84	\$1,769.00	\$1,885.00		

Low Profile Skidsteer Bucket	Inside Width	Struck Cap - Level	SAE Cap - Heaped	Weight	Part #	Price Code			
						A	B	C	D
Heavy Duty		cu ft	cu ft	in lbs					
48" HD Low Pro Skidsteer Bucket	48"	8.3	11.3	470	SBLP48HD	\$1,629.00	\$1,745.00		
54" HD Low Pro Skidsteer Bucket	54"	9.4	12.8	505	SBLP54HD	\$1,769.00	\$1,885.00		
60" HD Low Pro Skidsteer Bucket	60"	10.4	14.3	545	SBLP60HD	\$1,873.00	\$1,989.00		
66" HD Low Pro Skidsteer Bucket	66"	11.4	16.1	580	SBLP66HD	\$2,026.00	\$2,142.00		
72" HD Low Pro Skidsteer Bucket	72"	12.5	17.4	625	SBLP72HD	\$2,129.00	\$2,245.00		
78" HD Low Pro Skidsteer Bucket	78"	13.5	18.9	665	SBLP78HD	\$2,257.00	\$2,373.00		
84" HD Low Pro Skidsteer Bucket	84"	14.6	20.4	700	SBLP84HD	\$2,379.00	\$2,495.00		
96" HD Low Pro Skidsteer Bucket	96"	16.8	23.3	760	SBLP96HD	\$2,715.00	\$2,831.00		

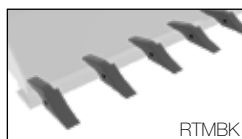
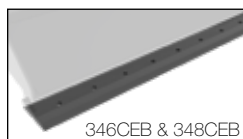

Bucket Accessories	UOM	Part #	Price
3/4 X 6 Double Bevel Bolt On Cutting Edge c/w Bolts & Nuts	ft	346CEB	\$86.00
3/4 X 8 Double Bevel Bolt On Cutting Edge c/w Bolts & Nuts	ft	348CEB	\$113.00
3/4 X 6 Single Bevel Serrated Bolt On Cutting Edge c/w Bolts & Nuts	ft	346CESB	\$107.00
Knock On Ripper Teeth c/w Weld On Adapter & Flex Pin	ea	RTMBK	\$86.00

HLA
SALES
TIP

High Heel Bucket Option Available on Skidsteer Buckets.

Specifically for large wheeled or track machines that need the quick attach bracket mounted 1-1/2" higher to allow the bucket to sit flat on the ground.
To order add "F" to the bucket part number of your choice (ie: SBLP72FBO500)
Additional price for this option is \$360.00



SBLP72T8

Regular duty

- 3/16" material, 1/4" end plates
- 3/4 X 4 bevelled cutting edge
- Reinforced top lip
- 32" deep, 19" high
- Lower back and longer base enables operator to see cutting edge of bucket
- Tapered end plates are self-cleaning and reduces material build-up

Heavy duty

- 1/4" material, 1/4" end plates
- 3/4 X 6 bevelled cutting edge
- Reinforced top lip
- 34" deep, 19" high
- Lower back and longer base enables operator to see cutting edge of bucket

Add 2" to Inside Width column to calculate Outside Width of bucket

Low Profile Skidsteer Bucket c/w Digging Teeth	Inside Width	Struck Cap - Level	SAE Cap - Heaped	# of Digging Teeth	Weight	Part #	Price Code				
		cu ft	cu ft				A	B	C	D	
Regular Duty					in lbs						
48" RD Low Pro Skidsteer Bucket 6 - Digging Teeth	48"	8.3	11.3	6	435	SBLP48T6	\$1,837.00	\$1,953.00			
54" RD Low Pro Skidsteer Bucket 6 - Digging Teeth	54"	9.4	12.8	6	465	SBLP54T6	\$1,885.00	\$2,001.00			
60" RD Low Pro Skidsteer Bucket 7 - Digging Teeth	60"	10.4	14.3	7	490	SBLP60T7	\$2,001.00	\$2,117.00			
66" RD Low Pro Skidsteer Bucket 7 - Digging Teeth	66"	11.4	16.1	7	520	SBLP66T7	\$2,068.00	\$2,184.00			
72" RD Low Pro Skidsteer Bucket 8 - Digging Teeth	72"	12.5	17.4	8	550	SBLP72T8	\$2,196.00	\$2,312.00			
78" RD Low Pro Skidsteer Bucket 8 - Digging Teeth	78"	13.5	18.9	8	590	SBLP78T8	\$2,288.00	\$2,404.00			
84" RD Low Pro Skidsteer Bucket 9 - Digging Teeth	84"	14.6	20.4	9	620	SBLP84T9	\$2,495.00	\$2,611.00			

Low Profile Skidsteer Bucket c/w Digging Teeth	Inside Width	Struck Cap - Level	SAE Cap - Heaped	# of Digging Teeth	Weight	Part #	Price Code				
		cu ft	cu ft				A	B	C	D	
Heavy Duty					in lbs						
48" HD Low Pro Skidsteer Bucket 6 - Digging Teeth	48"	8.3	11.3	6	515	SBLP48HDT6	\$2,117.00	\$2,233.00			
54" HD Low Pro Skidsteer Bucket 6 - Digging Teeth	54"	9.4	12.8	6	550	SBLP54HDT6	\$2,257.00	\$2,373.00			
60" HD Low Pro Skidsteer Bucket 7 - Digging Teeth	60"	10.4	14.3	7	590	SBLP60HDT7	\$2,440.00	\$2,556.00			
66" HD Low Pro Skidsteer Bucket 7 - Digging Teeth	66"	11.4	16.1	7	625	SBLP66HDT7	\$2,593.00	\$2,709.00			
72" HD Low Pro Skidsteer Bucket 8 - Digging Teeth	72"	12.5	17.4	8	680	SBLP72HDT8	\$2,776.00	\$2,892.00			
78" HD Low Pro Skidsteer Bucket 8 - Digging Teeth	78"	13.5	18.9	8	715	SBLP78HDT8	\$2,904.00	\$3,020.00			
84" HD Low Pro Skidsteer Bucket 9 - Digging Teeth	84"	14.6	20.4	9	755	SBLP84HDT9	\$3,105.00	\$3,221.00			
96" HD Low Pro Skidsteer Bucket 9 - Digging Teeth	96"	16.8	23.3	9	815	SBLP96HDT9	\$3,441.00	\$3,557.00			

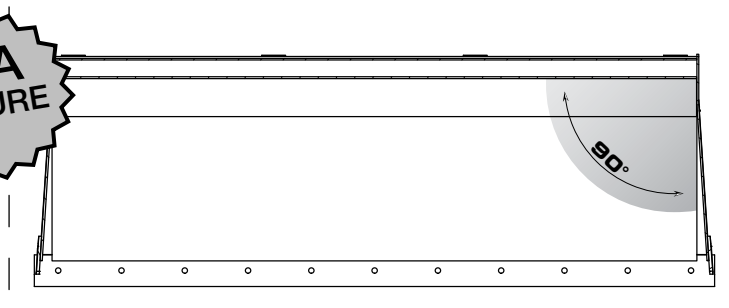

HLA Tapered Bucket Feature

The new profile on HLA buckets allows for improved release of materials during dumping. The new tapered design helps reduce material packing in the corners improving material clean out.

BUCKETS

Buckets



MB66

Regular duty

- 3/16" material, 1/4" end plates
- 3/4 X 4 bevelled cutting edge
- 28" deep, 25" high
- Reinforced round back and end plates for strength, easy filling & clean out
- Flat top acts as level indicator
- Drilled for standard bolt on cutting edge

Heavy duty

- 1/4" material, 1/4" end plates
- 3/4 X 6 bevelled cutting edge
- Reinforced top lip
- 30" deep, 25" high
- Reinforced round back and end plates for strength, easy filling & clean out
- Flat top acts as level indicator
- Drilled for standard bolt on cutting edge

- Tapered end plates are self-cleaning and reduces material build-up

Add 2" to Inside Width column to calculate Outside Width of bucket

Standard Front End Loader Bucket	Inside Width	Struck Cap - Level	SAE Cap - Heaped	Weight	Part #	Price Code			
						A	B	C	D
Regular Duty		cu ft	cu ft	in lbs					
48" RD Standard Material Bucket	48"	11.2	13.9	385	MB48	\$1,349.00	\$1,465.00	\$1,581.00	\$1,728.00
54" RD Standard Material Bucket	54"	12.6	15.8	415	MB54	\$1,397.00	\$1,513.00	\$1,629.00	\$1,776.00
60" RD Standard Material Bucket	60"	14.0	17.6	440	MB60	\$1,434.00	\$1,550.00	\$1,666.00	\$1,813.00
66" RD Standard Material Bucket	66"	15.5	19.4	465	MB66	\$1,501.00	\$1,617.00	\$1,733.00	\$1,880.00
72" RD Standard Material Bucket	72"	16.9	21.3	490	MB72	\$1,550.00	\$1,666.00	\$1,782.00	\$1,929.00
78" RD Standard Material Bucket	78"	18.3	23.1	525	MB78	\$1,641.00	\$1,757.00	\$1,873.00	\$2,020.00
84" RD Standard Material Bucket	84"	19.7	24.9	550	MB84	\$1,769.00	\$1,885.00	\$2,001.00	\$2,148.00
90" RD Standard Material Bucket	90"	21.0	26.8	590	MB90	\$1,934.00	\$2,050.00	\$2,166.00	\$2,313.00
96" RD Standard Material Bucket	96"	22.5	28.6	615	MB96	\$2,007.00	\$2,123.00	\$2,239.00	\$2,386.00
108" RD Standard Material Bucket	108"	25.3	32.3	675	MB108	\$2,221.00	\$2,337.00	\$2,453.00	\$2,600.00

Standard Front End Loader Bucket	Inside Width	Struck Cap - Level	SAE Cap - Heaped	Weight	Part #	Price Code			
						A	B	C	D
Heavy Duty		cu ft	cu ft	in lbs					
48" HD Standard Material Bucket	48"	11.2	13.9	470	MB48HD	\$1,629.00	\$1,745.00	\$1,861.00	\$2,008.00
54" HD Standard Material Bucket	54"	12.6	15.8	510	MB54HD	\$1,769.00	\$1,885.00	\$2,001.00	\$2,148.00
60" HD Standard Material Bucket	60"	14.0	17.6	545	MB60HD	\$1,873.00	\$1,989.00	\$2,105.00	\$2,252.00
66" HD Standard Material Bucket	66"	15.5	19.4	585	MB66HD	\$2,026.00	\$2,142.00	\$2,258.00	\$2,405.00
72" HD Standard Material Bucket	72"	16.9	21.3	630	MB72HD	\$2,129.00	\$2,245.00	\$2,361.00	\$2,508.00
78" HD Standard Material Bucket	78"	18.3	23.1	670	MB78HD	\$2,257.00	\$2,373.00	\$2,489.00	\$2,636.00
84" HD Standard Material Bucket	84"	19.7	24.9	700	MB84HD	\$2,379.00	\$2,495.00	\$2,611.00	\$2,758.00
90" HD Standard Material Bucket	90"	21.0	26.8	740	MB90HD	\$2,501.00	\$2,617.00	\$2,733.00	\$2,880.00
96" HD Standard Material Bucket	96"	22.5	28.6	790	MB96HD	\$2,715.00	\$2,831.00	\$2,947.00	\$3,094.00
108" HD Standard Material Bucket	108"	25.3	32.3	875	MB108HD	\$3,313.00	\$3,429.00	\$3,545.00	\$3,692.00

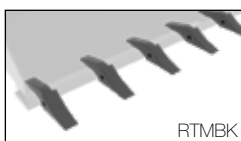
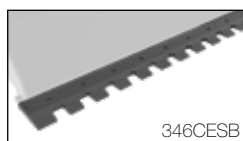
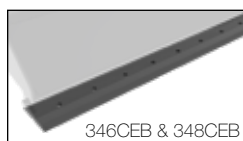

Bucket Accessories

	UOM	Part #	Price
3/4 X 6 Double Bevel Bolt On Cutting Edge c/w Bolts & Nuts	ft	346CEB	\$86.00
3/4 X 8 Double Bevel Bolt On Cutting Edge c/w Bolts & Nuts	ft	348CEB	\$113.00
3/4 X 6 Single Bevel Serrated Bolt On Cutting Edge c/w Bolts & Nuts	ft	346CESB	\$107.00
Knock On Ripper Teeth c/w Weld On Adapter & Flex Pin	ea	RTMBK	\$86.00

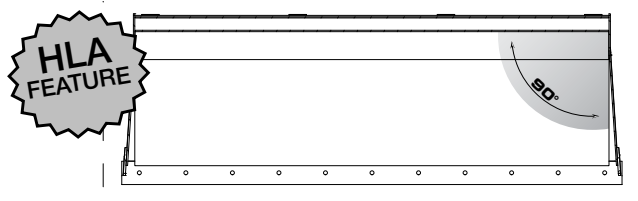

HLA Tapered Bucket Feature

The new profile on HLA buckets allows for improved release of materials during dumping. The new tapered design helps reduce material packing in the corners improving material clean out.



Regular duty

- 3/16" material, 1/4" end plates
- 3/4 X 4 bevelled cutting edge
- 28" deep, 26" high
- Reinforced round back and end plates for strength, easy filling & clean out
- Flat top acts as level indicator
- Drilled for standard bolt on cutting edge

Heavy duty

- 1/4" material, 1/4" end plates
- 3/4 X 6 bevelled cutting edge
- Reinforced top lip
- 30" deep, 26" high
- Reinforced round back and end plates for strength, easy filling & clean out
- Flat top acts as level indicator
- Drilled for standard bolt on cutting edge

- Tapered end plates are self-cleaning and reduces material build-up

SB72

Add 2" to Inside Width column to calculate Outside Width of bucket

Standard Skidsteer Bucket	Inside Width	Struck Cap - Level	SAE Cap - Heaped	Weight	Part #	Price Code			
						A	B	C	D
Regular Duty		cu ft	cu ft	in lbs					
48" RD Standard Skidsteer Bucket	48"	11.0	13.6	400	SB48	\$1,349.00	\$1,465.00	\$1,581.00	\$1,728.00
54" RD Standard Skidsteer Bucket	54"	12.3	15.4	425	SB54	\$1,397.00	\$1,513.00	\$1,629.00	\$1,776.00
60" RD Standard Skidsteer Bucket	60"	13.7	17.2	455	SB60	\$1,434.00	\$1,550.00	\$1,666.00	\$1,813.00
66" RD Standard Skidsteer Bucket	66"	15.0	19.0	480	SB66	\$1,501.00	\$1,617.00	\$1,733.00	\$1,880.00
72" RD Standard Skidsteer Bucket	72"	16.5	20.8	510	SB72	\$1,550.00	\$1,666.00	\$1,782.00	\$1,929.00
78" RD Standard Skidsteer Bucket	78"	17.8	22.5	545	SB78	\$1,641.00	\$1,757.00	\$1,873.00	\$2,020.00
84" RD Standard Skidsteer Bucket	84"	19.2	24.3	575	SB84	\$1,769.00	\$1,885.00	\$2,001.00	\$2,148.00
90" RD Standard Skidsteer Bucket	90"	20.6	26.1	610	SB90	\$1,934.00	\$2,050.00	\$2,166.00	\$2,313.00
96" RD Standard Skidsteer Bucket	96"	21.9	27.9	640	SB96	\$2,007.00	\$2,123.00	\$2,239.00	\$2,386.00

Standard Skidsteer Bucket	Inside Width	Struck Cap - Level	SAE Cap - Heaped	Weight	Part #	Price Code			
						A	B	C	D
Heavy Duty		cu ft	cu ft	in lbs					
48" HD Standard Skidsteer Bucket	48"	11.0	13.6	475	SB48HD	\$1,629.00	\$1,745.00	\$1,861.00	\$2,008.00
54" HD Standard Skidsteer Bucket	54"	12.3	15.4	515	SB54HD	\$1,769.00	\$1,885.00	\$2,001.00	\$2,148.00
60" HD Standard Skidsteer Bucket	60"	13.7	17.2	550	SB60HD	\$1,873.00	\$1,989.00	\$2,105.00	\$2,252.00
66" HD Standard Skidsteer Bucket	66"	15.0	19.0	590	SB66HD	\$2,026.00	\$2,142.00	\$2,258.00	\$2,405.00
72" HD Standard Skidsteer Bucket	72"	16.5	20.8	625	SB72HD	\$2,129.00	\$2,245.00	\$2,361.00	\$2,508.00
78" HD Standard Skidsteer Bucket	78"	17.8	22.5	675	SB78HD	\$2,257.00	\$2,373.00	\$2,489.00	\$2,636.00
84" HD Standard Skidsteer Bucket	84"	19.2	24.3	710	SB84HD	\$2,379.00	\$2,495.00	\$2,611.00	\$2,758.00
90" HD Standard Skidsteer Bucket	90"	20.6	26.1	760	SB90HD	\$2,501.00	\$2,617.00	\$2,733.00	\$2,880.00
96" HD Standard Skidsteer Bucket	96"	21.9	27.9	795	SB96HD	\$2,715.00	\$2,831.00	\$2,947.00	\$3,094.00



- 1/4" material, 1/4" end plates
- 3/4 X 6 bevelled cutting edge
- Reinforced top lip
- 40" deep, 24" high
- Reinforced round back and end plates for strength, easy filling & clean out
- Flat top acts as level indicator
- Tapered end plates are self-cleaning and reduces material build-up
- Drilled for standard bolt on cutting edge

SB7840HD

Add 2" to Inside Width column to calculate Outside Width of bucket

Standard Skidsteer Bucket - Long Lip	Inside Width	Struck Cap - Level	SAE Cap - Heaped	Weight	Part #	Price Code			
						A	B	C	D
Heavy Duty		cu ft	cu ft	in lbs					
72" HD Standard Skidsteer Bucket - Long Lip	72"	20.6	26.9	720	SB7240HD	\$2,379.00	\$2,495.00	\$2,611.00	\$2,758.00
78" HD Standard Skidsteer Bucket - Long Lip	78"	22.3	29.3	775	SB7840HD	\$2,477.00	\$2,593.00	\$2,709.00	\$2,856.00
84" HD Standard Skidsteer Bucket - Long Lip	84"	24.0	31.7	815	SB8440HD	\$2,642.00	\$2,758.00	\$2,874.00	\$3,021.00
96" HD Standard Skidsteer Bucket - Long Lip	96"	27.5	35.9	920	SB9640HD	\$2,965.00	\$3,081.00	\$3,197.00	\$3,344.00

Buckets



MBHV66

Regular duty

- 3/16" material, 1/4" end plates
- 3/4 X 4 bevelled cutting edge
- Reinforced top lip
- 34" deep, 30" high
- Reinforced round back and end plates for strength, easy filling & clean out
- Flat top acts as level indicator
- Drilled for standard bolt on cutting edge
- Tapered end plates are self-cleaning and reduces material build-up

Heavy duty

- 1/4" material, 1/4" end plates
- 3/4 X 6 bevelled cutting edge
- Reinforced top lip
- 36" deep, 30" high
- Reinforced round back and end plates for strength, easy filling & clean out
- Flat top acts as level indicator
- Drilled for standard bolt on cutting edge

Add 2" to Inside Width column to calculate Outside Width of bucket

High Volume Front End Loader Bucket	Inside Width	Struck Cap - Level	SAE Cap - Heaped	Weight	Part #	Price Code			
						A	B	C	D
Regular Duty		cu ft	cu ft	in lbs					
60" RD HV Material Bucket	60"	22.7	27.2	545	MBHV60	\$1,745.00	\$1,861.00	\$1,977.00	\$2,124.00
66" RD HV Material Bucket	66"	25.0	30.0	560	MBHV66	\$1,830.00	\$1,946.00	\$2,062.00	\$2,209.00
72" RD HV Material Bucket	72"	27.3	32.9	590	MBHV72	\$1,898.00	\$2,014.00	\$2,130.00	\$2,277.00
78" RD HV Material Bucket	78"	29.5	35.7	635	MBHV78	\$2,056.00	\$2,172.00	\$2,288.00	\$2,435.00
84" RD HV Material Bucket	84"	31.8	38.5	665	MBHV84	\$2,257.00	\$2,373.00	\$2,489.00	\$2,636.00
96" RD HV Material Bucket	96"	36.3	44.2	705	MBHV96	\$2,520.00	\$2,636.00	\$2,752.00	\$2,899.00
108" RD HV Material Bucket	108"	40.9	49.9	920	MBHV108	\$3,118.00	\$3,234.00	\$3,350.00	\$3,497.00

High Volume Front End Loader Bucket	Inside Width	Struck Cap - Level	SAE Cap - Heaped	Weight	Part #	Price Code			
						A	B	C	D
Heavy Duty		cu ft	cu ft	in lbs					
60" HD HV Material Bucket	60"	22.7	27.2	655	MBHV60HD	\$2,184.00	\$2,300.00	\$2,416.00	\$2,563.00
66" HD HV Material Bucket	66"	25.0	30.0	695	MBHV66HD	\$2,318.00	\$2,434.00	\$2,550.00	\$2,697.00
72" HD HV Material Bucket	72"	27.3	32.9	740	MBHV72HD	\$2,495.00	\$2,611.00	\$2,727.00	\$2,874.00
78" HD HV Material Bucket	78"	29.5	35.7	795	MBHV78HD	\$2,623.00	\$2,739.00	\$2,855.00	\$3,002.00
84" HD HV Material Bucket	84"	31.8	38.5	835	MBHV84HD	\$2,819.00	\$2,935.00	\$3,051.00	\$3,198.00
96" HD HV Material Bucket	96"	36.3	44.2	935	MBHV96HD	\$3,130.00	\$3,246.00	\$3,362.00	\$3,509.00
108" HD HV Material Bucket	108"	40.9	49.9	1145	MBHV108HD	\$3,935.00	\$4,051.00	\$4,167.00	\$4,314.00
120" HD HV Material Bucket	120"	43.2	54.0	1230	MBHV120HD	\$4,911.00	\$5,027.00	\$5,143.00	\$5,290.00

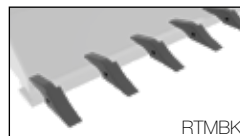
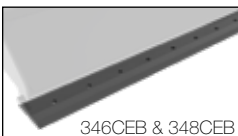

Bucket Accessories	UOM	Part #	Price
3/4 X 6 Double Bevel Bolt On Cutting Edge c/w Bolts & Nuts	ft	346CEB	\$86.00
3/4 X 8 Double Bevel Bolt On Cutting Edge c/w Bolts & Nuts	ft	348CEB	\$113.00
3/4 X 6 Single Bevel Serrated Bolt On Cutting Edge c/w Bolts & Nuts	ft	346CESB	\$107.00
Knock On Ripper Teeth c/w Weld On Adapter & Flex Pin	ea	RTMBK	\$86.00

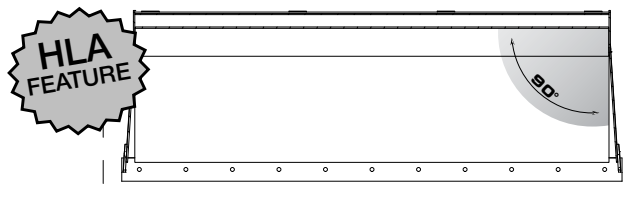

HLA Tapered Bucket Feature

The new profile on HLA buckets allows for improved release of materials during dumping. The new tapered design helps reduce material packing in the corners improving material clean out.



SBHV66

Regular duty

- 3/16" material, 1/4" end plates
- 3/4 X 4 bevelled cutting edge
- Reinforced top lip
- 34" deep, 31" high
- Reinforced round back and end plates for strength, easy filling & clean out
- Flat top acts as level indicator
- Drilled for standard bolt on cutting edge

Heavy duty

- 1/4" material, 1/4" end plates
- 3/4 X 6 bevelled cutting edge
- Reinforced top lip
- 36" deep, 31" high
- Reinforced round back and end plates for strength, easy filling & clean out
- Flat top acts as level indicator
- Drilled for standard bolt on cutting edge

• Tapered end plates are self-cleaning and reduces material build-up

Add 2" to Inside Width column to calculate Outside Width of bucket

High Volume Skidsteer Bucket	Inside Width	Struck Cap - Level	SAE Cap - Heaped	Weight	Part #	Price Code			
						A	B	C	D
Regular Duty		cu ft	cu ft	in lbs					
60" RD HV Skidsteer Bucket	60"	20.8	25.5	540	SBHV60	\$1,745.00	\$1,861.00	\$1,977.00	\$2,124.00
66" RD HV Skidsteer Bucket	66"	22.9	28.1	570	SBHV66	\$1,830.00	\$1,946.00	\$2,062.00	\$2,209.00
72" RD HV Skidsteer Bucket	72"	25.0	30.8	605	SBHV72	\$1,898.00	\$2,014.00	\$2,130.00	\$2,277.00
78" RD HV Skidsteer Bucket	78"	27.1	33.5	650	SBHV78	\$2,056.00	\$2,172.00	\$2,288.00	\$2,435.00
84" RD HV Skidsteer Bucket	84"	29.1	36.1	680	SBHV84	\$2,257.00	\$2,373.00	\$2,489.00	\$2,636.00
96" RD HV Skidsteer Bucket	96"	33.3	41.5	760	SBHV96	\$2,520.00	\$2,636.00	\$2,752.00	\$2,899.00
108" RD HV Skidsteer Bucket	108"	37.5	46.8	835	SBHV108	\$3,118.00	\$3,234.00	\$3,350.00	\$3,497.00

High Volume Skidsteer Bucket	Inside Width	Struck Cap - Level	SAE Cap - Heaped	Weight	Part #	Price Code			
						A	B	C	D
Heavy Duty		cu ft	cu ft	in lbs					
60" HD HV Skidsteer Bucket	60"	20.8	25.5	650	SBHV60HD	\$2,184.00	\$2,300.00	\$2,416.00	\$2,563.00
66" HD HV Skidsteer Bucket	66"	22.9	28.1	695	SBHV66HD	\$2,318.00	\$2,434.00	\$2,550.00	\$2,697.00
72" HD HV Skidsteer Bucket	72"	25.0	30.8	740	SBHV72HD	\$2,495.00	\$2,611.00	\$2,727.00	\$2,874.00
78" HD HV Skidsteer Bucket	78"	27.1	33.5	795	SBHV78HD	\$2,623.00	\$2,739.00	\$2,855.00	\$3,002.00
84" HD HV Skidsteer Bucket	84"	29.1	36.1	840	SBHV84HD	\$2,819.00	\$2,935.00	\$3,051.00	\$3,198.00
96" HD HV Skidsteer Bucket	96"	33.3	41.5	940	SBHV96HD	\$3,130.00	\$3,246.00	\$3,362.00	\$3,509.00
108" HD HV Skidsteer Bucket	108"	37.5	46.8	1040	SBHV108HD	\$3,935.00	\$4,051.00	\$4,167.00	\$4,314.00



SBHV7840HD

- 1/4" material, 1/4" end plates
- 3/4 X 6 bevelled cutting edge
- Reinforced top lip
- 38" deep, 31" high
- Reinforced round back and end plates for strength, easy filling & clean out
- Flat top acts as level indicator
- Tapered end plates are self-cleaning and reduces material build-up
- Drilled for standard bolt on cutting edge

High Volume Skidsteer Bucket - Long Lip	Inside Width	Struck Cap - Level	SAE Cap - Heaped	Weight	Part #	Price Code			
						A	B	C	D
Heavy Duty		cu ft	cu ft	in lbs					
72" HD HV Skidsteer Bucket - Long Lip	72"	28.4	34.7	795	SBHV7240HD	\$2,849.00	\$2,965.00	\$3,081.00	\$3,228.00
78" HD HV Skidsteer Bucket - Long Lip	78"	30.7	37.6	855	SBHV7840HD	\$3,026.00	\$3,142.00	\$3,258.00	\$3,405.00
84" HD HV Skidsteer Bucket - Long Lip	84"	33.1	40.5	900	SBHV8440HD	\$3,270.00	\$3,386.00	\$3,502.00	\$3,649.00
96" HD HV Skidsteer Bucket - Long Lip	96"	37.8	46.3	1005	SBHV9640HD	\$3,673.00	\$3,789.00	\$3,905.00	\$4,052.00

Buckets



MBHVX66

Regular duty

- 3/16" material, 1/4" end plates
- 3/4 X 4 bevelled cutting edge
- Reinforced top lip
- 39" deep, 34" high
- Reinforced round back and end plates for strength, easy filling & clean out
- Flat top acts as level indicator
- Drilled for standard bolt on cutting edge
- Tapered end plates are self-cleaning and reduces material build-up

Heavy duty

- 1/4" material, 1/4" end plates
- 3/4 X 6 bevelled cutting edge
- Reinforced top lip
- 41" deep, 34" high
- Reinforced round back and end plates for strength, easy filling & clean out
- Flat top acts as level indicator
- Drilled for standard bolt on cutting edge

Add 2" to Inside Width column to calculate Outside Width of bucket

Extra High Volume Front End Loader Bucket	Inside Width	Struck Cap - Level	SAE Cap - Heaped	Weight	Part #	Price Code			
						A	B	C	D
Regular Duty		cu ft	cu ft	in lbs					
60" HVX Material Bucket	60"	27.8	33.7	605	MBHVX60	\$2,032.00	\$2,148.00	\$2,264.00	\$2,411.00
66" HVX Material Bucket	66"	30.7	37.3	640	MBHVX66	\$2,184.00	\$2,300.00	\$2,416.00	\$2,563.00
72" HVX Material Bucket	72"	33.6	40.9	675	MBHVX72	\$2,337.00	\$2,453.00	\$2,569.00	\$2,716.00
78" HVX Material Bucket	78"	36.5	44.5	725	MBHVX78	\$2,471.00	\$2,587.00	\$2,703.00	\$2,850.00
84" HVX Material Bucket	84"	39.4	48.1	755	MBHVX84	\$2,617.00	\$2,733.00	\$2,849.00	\$2,996.00
96" HVX Material Bucket	96"	45.2	55.3	845	MBHVX96	\$2,910.00	\$3,026.00	\$3,142.00	\$3,289.00
108" HVX Material Bucket	108"	51.0	62.5	1015	MBHVX108	\$3,380.00	\$3,496.00	\$3,612.00	\$3,759.00

Extra High Volume Front End Loader Bucket	Inside Width	Struck Cap - Level	SAE Cap - Heaped	Weight	Part #	Price Code			
						A	B	C	D
Heavy Duty		cu ft	cu ft	in lbs					
60" HD HVX Material Bucket	60"	27.8	33.7	725	MBHVX60HD	\$3,130.00	\$3,246.00	\$3,362.00	\$3,509.00
66" HD HVX Material Bucket	66"	30.7	37.3	770	MBHVX66HD	\$3,331.00	\$3,447.00	\$3,563.00	\$3,710.00
72" HD HVX Material Bucket	72"	33.6	40.9	820	MBHVX72HD	\$3,508.00	\$3,624.00	\$3,740.00	\$3,887.00
78" HD HVX Material Bucket	78"	36.5	44.5	880	MBHVX78HD	\$3,709.00	\$3,825.00	\$3,941.00	\$4,088.00
84" HD HVX Material Bucket	84"	39.4	48.1	925	MBHVX84HD	\$3,898.00	\$4,014.00	\$4,130.00	\$4,277.00
96" HD HVX Material Bucket	96"	45.2	55.3	1035	MBHVX96HD	\$4,087.00	\$4,203.00	\$4,319.00	\$4,466.00
108" HD HVX Material Bucket	108"	51.0	62.5	1230	MBHVX108HD	\$4,447.00	\$4,563.00	\$4,679.00	\$4,826.00
120" HD HVX Material Bucket	120"	56.7	70.2	1350	MBHVX120HD	\$5,576.00	\$5,692.00	\$5,808.00	\$5,955.00

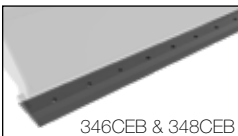

Bucket Accessories	UOM	Part #	Price
3/4 X 6 Double Bevel Bolt On Cutting Edge c/w Bolts & Nuts	ft	346CEB	\$86.00
3/4 X 8 Double Bevel Bolt On Cutting Edge c/w Bolts & Nuts	ft	348CEB	\$113.00
3/4 X 6 Single Bevel Serrated Bolt On Cutting Edge c/w Bolts & Nuts	ft	346CESB	\$107.00

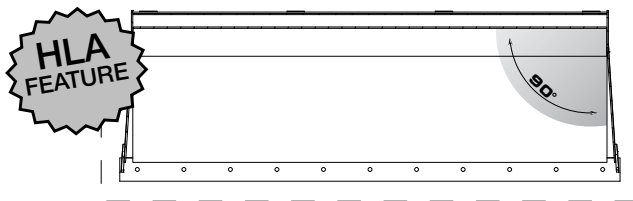

HLA Tapered Bucket Feature

The new profile on HLA buckets allows for improved release of materials during dumping. The new tapered design helps reduce material packing in the corners improving material clean out.



- 3/16" material, 1/4" end plates
- 3/4 X 4 bevelled cutting edge
- Reinforced top lip
- Screened back for better visibility
- 39" deep, 31" high
- Reinforced round back and end plates for strength, easy filling & clean out
- Flat top acts as level indicator
- Tapered end plates are self-cleaning and reduces material build-up
- Drilled for standard bolt on cutting edge

SBSN66

Add 2" to Inside Width column to calculate Outside Width of bucket

High Volume Skidsteer Snow Bucket	Inside Width	Struck Cap - Level	SAE Cap - Heaped	Weight	Part #	Price Code			
		cu ft	cu ft			A	B	C	D
60" HV Snow Bucket	60"	23.6	29.0	575	SBSN60	\$1,812.00	\$1,928.00	\$2,044.00	\$2,191.00
66" HV Snow Bucket	66"	25.9	32.0	610	SBSN66	\$2,020.00	\$2,136.00	\$2,252.00	\$2,399.00
72" HV Snow Bucket	72"	28.3	35.1	645	SBSN72	\$2,148.00	\$2,264.00	\$2,380.00	\$2,527.00
78" HV Snow Bucket	78"	30.7	38.1	690	SBSN78	\$2,404.00	\$2,520.00	\$2,636.00	\$2,783.00
84" HV Snow Bucket	84"	33.0	41.2	725	SBSN84	\$2,642.00	\$2,758.00	\$2,874.00	\$3,021.00
90" HV Snow Bucket	90"	35.4	44.2	775	SBSN90	\$2,733.00	\$2,849.00	\$2,965.00	\$3,112.00
96" HV Snow Bucket	96"	37.7	47.3	805	SBSN96	\$2,959.00	\$3,075.00	\$3,191.00	\$3,338.00
108" HV Snow Bucket	108"	42.5	53.3	940	SBSN108	\$3,709.00	\$3,825.00	\$3,941.00	\$4,088.00
120" HV Snow Bucket	120"	47.2	59.4	1010	SBSN120	\$4,502.00	\$4,618.00	\$4,734.00	\$4,881.00



- No sharp edges for gentle handling of produce
- Screened back for better visibility
- 31" deep, 31" high
- Made of the same material as standard bucket
- Drilled with counter sink holes for special produce bolt on cutting edge

SBP66

Add 1" to Inside Width column to calculate Outside Width of bucket

Produce Skidsteer Bucket	Inside Width	Struck Cap - Level	SAE Cap - Heaped	Weight	UOM	Part #	Price Code			
		cu ft	cu ft				A	B	C	D
60" Produce Skidsteer Bucket	60"	18.5	22.9	550	ea	SBP60	\$2,068.00	\$2,184.00		
66" Produce Skidsteer Bucket	66"	20.6	25.3	585	ea	SBP66	\$2,148.00	\$2,264.00		
72" Produce Skidsteer Bucket	72"	22.4	27.7	620	ea	SBP72	\$2,221.00	\$2,337.00		
78" Produce Skidsteer Bucket	78"	24.3	30.1	670	ea	SBP78	\$2,434.00	\$2,550.00		
84" Produce Skidsteer Bucket	84"	26.2	32.5	705	ea	SBP84	\$2,617.00	\$2,733.00		

Bolt on Edge for Produce Bucket

	UOM	Part #	Price
3/4 x 6 Single Bevel Bolt On Cutting Edge (drilled and tapped) c/w Countersink Bolts and Nuts	ft	346CEPB	\$129.00

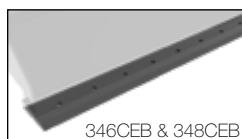

Bucket Accessories

	UOM	Part #	Price
3/4 X 6 Double Bevel Bolt On Cutting Edge c/w Bolts & Nuts	ft	346CEB	\$86.00
3/4 X 8 Double Bevel Bolt On Cutting Edge c/w Bolts & Nuts	ft	348CEB	\$113.00
3/4 X 6 Single Bevel Serrated Bolt On Cutting Edge c/w Bolts & Nuts	ft	346CESB	\$107.00

Buckets



- 3/16" material, 1/4" end plates
- 3/4 X 6 bevelled cutting edge
- Reinforced top lip
- 43" deep, 35" high
- 3/4 x 8 bolt-on double bevel edge optional
- Drilled for standard bolt on cutting edge

THMB84

Add 2" to Inside Width column to calculate Outside Width of bucket

Telescopic Handler Bucket Standard	Inside Width	Struck Cap - Level	SAE Cap - Heaped	Weight	UOM	Part #	Price Code			
		cu yd	cu yd				A	B	C	D
84" Standard Telescopic Handler Bucket	84"	1.47	1.82	1045	ea	THMB84	\$4,813.00	\$4,929.00	\$5,045.00	\$5,192.00
96" Standard Telescopic Handler Bucket	96"	1.7	2.1	1095	ea	THMB96	\$5,521.00	\$5,637.00	\$5,753.00	\$5,900.00
108" Standard Telescopic Handler Bucket	108"	1.89	2.34	1130	ea	THMB108	\$6,210.00	\$6,326.00	\$6,442.00	\$6,589.00



- 1/4" material, 1/4" end plates
- 3/4 X 6 bevelled cutting edge
- Reinforced top lip
- 47" deep, 41" high
- 3/4 x 8 bolt-on double bevel edge optional
- Drilled for standard bolt on cutting edge

THMBHV84

Add 2" to Inside Width column to calculate Outside Width of bucket

Telescopic Handler Bucket High Volume	Inside Width	Struck Cap - Level	SAE Cap - Heaped	Weight	UOM	Part #	Price Code			
		cu yd	cu yd				A	B	C	D
84" High Volume Telescopic Handler Bucket	84"	1.96	2.38	1285	ea	THMBHV84	\$5,820.00	\$5,936.00	\$6,052.00	\$6,199.00
96" High Volume Telescopic Handler Bucket	96"	2.2	2.7	1400	ea	THMBHV96	\$6,570.00	\$6,686.00	\$6,802.00	\$6,949.00
108" High Volume Telescopic Handler Bucket	108"	2.52	3.06	1515	ea	THMBHV108	\$7,339.00	\$7,455.00	\$7,571.00	\$7,718.00

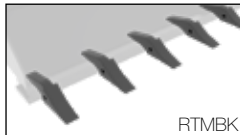
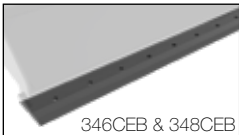

Telescopic Handler and High Dump Bucket Accessories	UOM	Part #	Price
3/4 X 6 Double Bevel Bolt On Cutting Edge c/w Bolts & Nuts (high dump only)	ft	346CEB	\$86.00
3/4 X 8 Double Bevel Bolt On Cutting Edge c/w Bolts & Nuts	ft	348CEB	\$113.00
3/4 X 6 Single Bevel Serrated Bolt On Cutting Edge c/w Bolts & Nuts	ft	346CESB	\$107.00
Knock On Ripper Teeth c/w Weld On Adapter & Flex Pin (high dump only)	ea	RTMBK	\$86.00
Optional 90" Hose Kit c/w Flat Faced Couplers (high dump only)		HK90	\$324.00
Optional Spring Hose Mount Kit (high dump only)		SHMK	\$147.00



- 1/4" material, 1/4" end plates
- 3/4 X 6 bevelled cutting edge
- Reinforced top lip
- 55" deep, 46" high
- 3/4 x 8 bolt-on double bevel edge optional
- Drilled for standard bolt on cutting edge

THMBHVX78

Add 2" to Inside Width column to calculate Outside Width of bucket

Telescopic Handler Bucket Extra High Volume	Inside Width	Struck Cap - Level	SAE Cap - Heaped	Weight	UOM	Part #	Price Code			
		cu yd	cu yd	in lbs			A	B	C	D
84" Extra High Volume Telescopic Handler Bucket	84"	2.5	3.1	1505	ea	THMBHVX84	\$7,107.00	\$7,223.00	\$7,339.00	\$7,486.00
96" Extra High Volume Telescopic Handler Bucket	96"	2.8	3.5	1640	ea	THMBHVX96	\$7,821.00	\$7,937.00	\$8,053.00	\$8,200.00
108" Extra High Volume Telescopic Handler Bucket	108"	3.2	4	1750	ea	THMBHVX108	\$8,522.00	\$8,638.00	\$8,754.00	\$8,901.00



- Includes 2 1/2" x 8" cylinders
- Main bucket material 1/4"
- 3/8" end plates
- 3/8" clam floor bottom
- Skidsteer - 29" deep, 20" high
- Loader - 33" deep, 26" high
- Drilled for standard bolt on cutting edge

SBFNO66

Add 2" to Inside Width column to calculate Outside Width of bucket

4 - In - 1 Bucket	Inside Width	Struck Cap - Level	SAE Cap - Heaped	Weight	Part #	Price Code			
				in lbs		A	B	C	D
66" 4 - In - 1 Skidsteer Bucket	66"	10.6 cu ft	12.8 cu ft	880	SBFNO66	\$4,887.00	\$5,003.00	\$5,119.00	\$5,266.00
66" 4 - In - 1 Loader Bucket	66"	15.7 cu ft	20.0 cu ft	1015	MBFNO66	\$4,887.00	\$5,003.00	\$5,119.00	\$5,266.00
72" 4 - In - 1 Skidsteer Bucket	72"	11.6 cu ft	15.1 cu ft	935	SBFNO72	\$5,124.00	\$5,240.00	\$5,356.00	\$5,503.00
72" 4 - In - 1 Loader Bucket	72"	17.1 cu ft	21.9 cu ft	1020	MBFNO72	\$5,124.00	\$5,240.00	\$5,356.00	\$5,503.00
78" 4 - In - 1 Skidsteer Bucket	78"	12.5 cu ft	16.4 cu ft	980	SBFNO78	\$5,356.00	\$5,472.00	\$5,588.00	\$5,735.00
78" 4 - In - 1 Loader Bucket	78"	18.5 cu ft	23.8 cu ft	1130	MBFNO78	\$5,356.00	\$5,472.00	\$5,588.00	\$5,735.00
84" 4 - In - 1 Skidsteer Bucket	84"	13.5 cu ft	17.7 cu ft	1040	SBFNO84	\$5,588.00	\$5,704.00	\$5,820.00	\$5,967.00
84" 4 - In - 1 Loader Bucket	84"	20.0 cu ft	25.7 cu ft	1195	MBFNO84	\$5,588.00	\$5,704.00	\$5,820.00	\$5,967.00
Optional 90" Hose Kit c/w Flat Faced Couplers					HK90	\$324.00			
Optional Spring Hose Mount Kit					SHMK	\$147.00			

Buckets



HRBH72 in lowered position



Bucket in dump position

- High dump bucket increases dump out height up to 48"
- Exclusive flat bottom bucket design allows for easier clean out & no capacity sacrifice
- Compact 28" deep, 21" high
- Standard 39" deep, 29" high
- HV 39" deep, 33" high
- Soft Stop Cylinder for reduced vibration
- Drilled for standard bolt on cutting edge

High Dump Bucket Compact	Outside Width	Struck Cap - Level	SAE Cap - Heaped	Weight in lbs	Part #	Price Code			
		cu ft	cu ft			A	B	C	D
36" High Dump Bucket Compact	36"	5.3	6.7	530	HRBC36	\$4,002.00	\$4,118.00	\$4,234.00	\$4,381.00
48" High Dump Bucket Compact	48"	7.4	9.6	595	HRBC48	\$4,405.00	\$4,521.00	\$4,637.00	\$4,784.00
54" High Dump Bucket Compact	54"	8.4	11.0	625	HRBC54	\$4,600.00	\$4,716.00	\$4,832.00	\$4,979.00
60" High Dump Bucket Compact	60"	9.5	12.5	655	HRBC60	\$4,813.00	\$4,929.00	\$5,045.00	\$5,192.00
Optional 90" Hose Kit c/w Flat Faced Couplers					HK90	\$324.00			
Optional 90" Hose Kit c/w 90° Flat Faced Couplers					HK9090	\$324.00			
Optional Spring Hose Mount Kit					SHMK	\$147.00			

High Dump Bucket Standard	Outside Width	Struck Cap - Level	SAE Cap - Heaped	Weight in lbs	Part #	Price Code			
		cu ft	cu ft			A	B	C	D
60" High Dump Bucket Standard	60"	17.9	23.2	870	HRB60	\$4,807.00	\$4,923.00	\$5,039.00	\$5,186.00
66" High Dump Bucket Standard	66"	19.9	25.9	905	HRB66	\$5,149.00	\$5,265.00	\$5,381.00	\$5,528.00
72" High Dump Bucket Standard	72"	21.9	28.7	955	HRB72	\$5,478.00	\$5,594.00	\$5,710.00	\$5,857.00
78" High Dump Bucket Standard	78"	23.9	31.5	1050	HRB78	\$5,808.00	\$5,924.00	\$6,040.00	\$6,187.00
84" High Dump Bucket Standard	84"	25.9	34.3	1085	HRB84	\$6,137.00	\$6,253.00	\$6,369.00	\$6,516.00
96" High Dump Bucket Standard	96"	29.9	39.9	1190	HRB96	\$6,802.00	\$6,918.00	\$7,034.00	\$7,181.00
Optional 90" Hose Kit c/w Flat Faced Couplers					HK90	\$324.00			
Optional 90" Hose Kit c/w 90° Flat Faced Couplers					HK9090	\$324.00			
Optional Spring Hose Mount Kit					SHMK	\$147.00			

High Dump Bucket High Volume	Outside Width	Struck Cap - Level	SAE Cap - Heaped	Weight in lbs	Part #	Price Code			
		cu ft	cu ft			A	B	C	D
60" High Dump Bucket High Volume	60"	24.2	28.8	980	HRBHV60	\$5,356.00	\$5,472.00	\$5,588.00	\$5,735.00
66" High Dump Bucket High Volume	66"	26.9	32.2	1030	HRBHV66	\$5,722.00	\$5,838.00	\$5,954.00	\$6,101.00
72" High Dump Bucket High Volume	72"	29.5	35.5	1100	HRBHV72	\$6,058.00	\$6,174.00	\$6,290.00	\$6,437.00
78" High Dump Bucket High Volume	78"	32.2	38.9	1205	HRBHV78	\$6,387.00	\$6,503.00	\$6,619.00	\$6,766.00
84" High Dump Bucket High Volume	84"	34.9	42.3	1230	HRBHV84	\$6,747.00	\$6,863.00	\$6,979.00	\$7,126.00
96" High Dump Bucket High Volume	96"	40.3	49.0	1340	HRBHV96	\$7,412.00	\$7,528.00	\$7,644.00	\$7,791.00
Optional 90" Hose Kit c/w Flat Faced Couplers					HK90	\$324.00			
Optional 90" Hose Kit c/w 90° Flat Faced Couplers					HK9090	\$324.00			
Optional Spring Hose Mount Kit					SHMK	\$147.00			



SGBC48

- 3/16" material, 1/4" end plates
- 3/4 X 4 bevelled cutting edge
- Single grapple arm
- 26" overall height
- 26" overall depth
- Opens to 36"
- Comes with 2 1/2" x 8" cylinder
- Drilled for standard bolt on cutting edge

Add 2" to Inside Width column to calculate Outside Width of bucket

Compact Scrap Grapple Bucket	Inside Width	Struck Cap - Level	SAE Cap - Heaped	Weight	Part #	Price Code			
						A	B	C	D
Skidsteer		cu ft	cu ft	in lbs					
36" Compact Scrap Grapple Bucket	36"	5.4	6.9	440	SGBC36	\$3,624.00	\$3,740.00	\$3,856.00	\$4,003.00
48" Compact Scrap Grapple Bucket	48"	7.2	9.2	450	SGBC48	\$3,721.00	\$3,837.00	\$3,953.00	\$4,100.00
54" Compact Scrap Grapple Bucket	54"	8.1	10.4	465	SGBC54	\$3,819.00	\$3,935.00	\$4,051.00	\$4,198.00
60" Compact Scrap Grapple Bucket	60"	9.0	11.6	480	SGBC60	\$3,929.00	\$4,045.00	\$4,161.00	\$4,308.00
Optional 90" Hose Kit c/w Flat Faced Couplers					HK90	\$324.00			
Optional 90" Hose Kit c/w 90° Flat Faced Couplers					HK9090	\$324.00			
Optional Spring Hose Mount Kit					SHMK	\$147.00			



SGB66

- **Two independent grapples**
- 1/4" material, 3/8" end plates
- 3/4 X 6 bevelled cutting edge
- Ideal for awkward abrasive loads
- 31" overall height
- 34" overall depth
- Comes with 2 1/2" x 8" cylinders
- Drilled for standard bolt on cutting edge

Add 2" to Inside Width column to calculate Outside Width of bucket

Scrap Grapple Bucket	Inside Width	Struck Cap - Level	SAE Cap - Heaped	Weight	Part #	Price Code			
						A	B	C	D
Skidsteer		cu ft	cu ft	in lbs					
54" Scrap Grapple Bucket	54"	11.9	15.3	970	SGB54	\$5,216.00	\$5,332.00	\$5,448.00	\$5,595.00
60" Scrap Grapple Bucket	60"	13.2	17.1	1015	SGB60	\$5,375.00	\$5,491.00	\$5,607.00	\$5,754.00
66" Scrap Grapple Bucket	66"	14.5	18.9	1050	SGB66	\$5,460.00	\$5,576.00	\$5,692.00	\$5,839.00
72" Scrap Grapple Bucket	72"	15.9	20.7	1090	SGB72	\$5,551.00	\$5,667.00	\$5,783.00	\$5,930.00
78" Scrap Grapple Bucket	78"	17.2	22.5	1135	SGB78	\$5,777.00	\$5,893.00	\$6,009.00	\$6,156.00
Optional 90" Hose Kit c/w Flat Faced Couplers					HK90	\$324.00			
Optional 90" Hose Kit c/w 90° Flat Faced Couplers					HK9090	\$324.00			
Optional Spring Hose Mount Kit					SHMK	\$147.00			



SDB66

- **Two independent grapples**
- **Replaceable tempered tines eliminate the need for a support bar at points which reduces lodging and jamming when emptying bucket**
- Designed to pick-up brush and other debris while leaving the dirt
- 39" Conus II cranked Kverneland tines (32" usable length)
- Cylinders completely protected from debris
- Comes with 2 1/2" x 8" cylinders
- 6" tine centres

Debris Grapple Fork	Width	Weight	UOM	Part #	Price Code			
					A	B	C	D
		in lbs						
66" Debris Grapple Fork - 11 Tines	66"	985	ea	SDB66	\$5,551.00	\$5,667.00	\$5,783.00	\$5,930.00
72" Debris Grapple Fork - 12 Tines	72"	1025	ea	SDB72	\$5,783.00	\$5,899.00	\$6,015.00	\$6,162.00
78" Debris Grapple Fork - 13 Tines	78"	1065	ea	SDB78	\$5,978.00	\$6,094.00	\$6,210.00	\$6,357.00
84" Debris Grapple Fork - 14 Tines	84"	1105	ea	SDB84	\$6,168.00	\$6,284.00	\$6,400.00	\$6,547.00
Optional 90" Hose Kit c/w Flat Faced Couplers				ea	HK90	\$324.00		
Optional 90" Hose Kit c/w 90° Flat Faced Couplers				ea	HK9090	\$324.00		
Optional Spring Hose Mount Kit					SHMK	\$147.00		

Grapples



- Two independent grapples
- Ideal for brush & rock clean up
- Ideal for awkward abrasive loads
- 30" overall height
- 40" overall depth
- Comes with 2½" x 8" cylinders

SFRDB70

Stone Fork (Retainer Style Tine) with Split Grapple	Weight	UOM	Part #	Price Code			
				A	B	C	D
Regular Duty - up to 5500 LB Capacity	in lbs						
62" Stone Fork Regular Duty with Split Grapple	1135	ea	SFRDB62	\$6,875.00	\$6,991.00	\$7,107.00	\$7,254.00
70" Stone Fork Regular Duty with Split Grapple	1195	ea	SFRDB70	\$7,107.00	\$7,223.00	\$7,339.00	\$7,486.00
77" Stone Fork Regular Duty with Split Grapple	1255	ea	SFRDB77	\$7,314.00	\$7,430.00	\$7,546.00	\$7,693.00
84" Stone Fork Regular Duty with Split Grapple	1315	ea	SFRDB84	\$7,528.00	\$7,644.00	\$7,760.00	\$7,907.00
92" Stone Fork Regular Duty with Split Grapple	1375	ea	SFRDB92	\$7,741.00	\$7,857.00	\$7,973.00	\$8,120.00
Optional 90" Hose Kit c/w Flat Faced Couplers		ea	HK90	\$324.00			
Optional 90" Hose Kit c/w 90° Flat Faced Couplers		ea	HK9090	\$324.00			
Optional Spring Hose Mount Kit		ea	SHMK	\$147.00			

Stone Fork (Retainer Style Tine) with Split Grapple	Weight	UOM	Part #	Price Code			
				A	B	C	D
Heavy Duty - up to 9500 LB Capacity	in lbs						
77" Stone Fork Heavy Duty with Split Grapple	1930	ea	SFRHDB77	\$13,207.00	\$13,323.00	\$13,439.00	\$13,586.00
85" Stone Fork Heavy Duty with Split Grapple	2050	ea	SFRHDB85	\$13,481.00	\$13,597.00	\$13,713.00	\$13,860.00
90" Stone Fork Heavy Duty with Split Grapple	2115	ea	SFRHDB90	\$13,738.00	\$13,854.00	\$13,970.00	\$14,117.00
94" Stone Fork Heavy Duty with Split Grapple	2175	ea	SFRHDB94	\$13,988.00	\$14,104.00	\$14,220.00	\$14,367.00
98" Stone Fork Heavy Duty with Split Grapple	2235	ea	SFRHDB98	\$14,262.00	\$14,378.00	\$14,494.00	\$14,641.00
103" Stone Fork Heavy Duty with Split Grapple	2295	ea	SFRHDB103	\$14,518.00	\$14,634.00	\$14,750.00	\$14,897.00
108" Stone Fork Heavy Duty with Split Grapple	2360	ea	SFRHDB108	\$14,775.00	\$14,891.00	\$15,007.00	\$15,154.00
Optional 90" Hose Kit c/w Flat Faced Couplers		ea	HK90	\$324.00			
Optional 90" Hose Kit c/w 90° Flat Faced Couplers		ea	HK9090	\$324.00			
Optional Spring Hose Mount Kit		ea	SHMK	\$147.00			



GRC42 (fork not included)

- To be fitted on models SBC, MBC & LDFE
- Heavy duty welded cylinder
- Opens up to 37½"

For "Package Pricing" add price of light duty manure fork

Compact Utility Grapple	Width	Weight	UOM	Part #	Price
42" Grapple Only To Fit 42" Fork c/w Cylinder	42"	129 lbs	ea	GRC42	\$1,159.00
48" Grapple Only To Fit 48" Fork c/w Cylinder	48"	136 lbs	ea	GRC48	\$1,220.00



GR66 (bucket not included)

- Can be fitted to models SB, SBHV, MB, MBHV, MFE, & SFR
- Accommodates 4ft round bales
- Works equally well on other materials such as manure, etc.
- Opens up to 70"

For "Package Pricing" add price of your desired bucket or fork

Regular Utility Grapple	Width	Weight	UOM	Part #	Price
66" Grapple Only To Fit 72" Fork Or Bucket c/w Cylinders	66"	475 lbs	ea	GR66	\$2,447.00
72" Grapple Only To Fit 84" Fork Or Bucket c/w Cylinders	72"	490 lbs	ea	GR72	\$2,617.00
84" Grapple Only To Fit 96" Fork Or Bucket c/w Cylinders	84"	515 lbs	ea	GR84	\$2,758.00
Optional 90" Hose Kit c/w Flat Faced Couplers			ea	HK90	\$324.00
Optional 90" Hose Kit c/w 90° Flat Faced Couplers			ea	HK9090	\$324.00



GRL84 (bucket not included)

- Can be fitted to models SB, SBHV, MB, MBHV, MBHVX, & THMB (Does not fit THMBHV & THMBHVX buckets)
- Specific heavy duty design for handling large round and square bales
- Opens up to 72"
- Removable / bolt-on mounting posts
- Accommodates 6ft round bales

For "Package Pricing" add price of your desired bucket or fork

Large Utility Grapple	Width	Weight	UOM	Part #	Price
72" Grapple Only To Fit 84" Fork Or Bucket c/w Cylinders	72"	640 lbs	ea	GRL72	\$3,471.00
84" Grapple Only To Fit 96" Fork Or Bucket c/w Cylinders	84"	655 lbs	ea	GRL84	\$3,685.00
96" Grapple Only To Fit 108" Fork Or Bucket c/w Cylinders	96"	690 lbs	ea	GRL96	\$4,142.00
Optional Bolt On Guard for GRL72 & GRL84		44 lbs	ea	LP101006	\$909.00
Optional Bolt On Guard for GRL96		52 lbs	ea	LP101576	\$1,092.00
Optional 90" Hose Kit c/w Flat Faced Couplers			ea	HK90	\$324.00
Optional 90" Hose Kit c/w 90° Flat Faced Couplers			ea	HK9090	\$324.00



GRX96 (bucket not included)

- Can be fitted to THMBHV & THMBHVX buckets
- Specific heavy duty design for handling large round and square bales
- Opens up to 72"
- Removable / bolt-on mounting posts
- Accommodates 6ft round bales

Extra Large Utility Grapple	Width	Weight	UOM	Part #	Price
84" Grapple Only To Fit 96" Fork Or Bucket c/w Cylinders	84"	775 lbs	ea	GRX84	\$3,782.00
96" Grapple Only To Fit 108" Fork Or Bucket c/w Cylinders	96"	810 lbs	ea	GRX96	\$4,240.00
Optional 90" Hose Kit c/w Flat Faced Couplers			ea	HK90	\$324.00
Optional 90" Hose Kit c/w 90° Flat Faced Couplers			ea	HK9090	\$324.00

Grapples

Skidsteer Grapple (Popular Package Pricing)



MFE72GRS66

- Designed for use on skidsteers with limited clearance for grapple arms
- Comes with 2½" x 8" cylinders

Manure Fork with Cranked Kverneland Tine & Skidsteer Grapple	Tine	Weight	UOM	Part #	Price Code			
	Centres	in lbs			A	B	C	D
66" Manure Fork Kverneland Tines & GRS60 Grapple	8"	745	ea	MFE66GRS60	\$4,380.00	\$4,496.00	\$4,612.00	\$4,759.00
72" Manure Fork Kverneland Tines & GRS66 Grapple	8 5/8"	765	ea	MFE72GRS66	\$4,496.00	\$4,612.00	\$4,728.00	\$4,875.00
84" Manure Fork Kverneland Tines & GRS72 Grapple	8 1/8"	845	ea	MFE84GRS72	\$4,880.00	\$4,996.00	\$5,112.00	\$5,259.00
96" Manure Fork Kverneland Tines & GRS84 Grapple	7 7/8"	935	ea	MFE96GRS84	\$5,509.00	\$5,625.00	\$5,741.00	\$5,888.00
Optional 90" Hose Kit c/w Flat Faced Couplers			ea	HK90	\$324.00			
Optional 90" Hose Kit c/w 90° Flat Faced Couplers			ea	HK9090	\$324.00			
Optional Spring Hose Mount Kit			ea	SHMK	\$147.00			



SFR77GRS66

- Designed for use on skidsteers with limited clearance for grapple arms
- Same great features as regular & heavy duty stone forks
- Comes with 2½" x 8" cylinders

Regular Duty Stone Fork with Retainer Style Tine & Skidsteer Grapple	Weight	UOM	Part #	Price Code			
	in lbs			A	B	C	D
70" Stone Fork Retainer Tine & GRS66 Grapple	1075	ea	SFR70GRS66	\$5,551.00	\$5,667.00	\$5,783.00	\$5,930.00
77" Stone Fork Retainer Tine & GRS66 Grapple	1130	ea	SFR77GRS66	\$5,759.00	\$5,875.00	\$5,991.00	\$6,138.00
84" Stone Fork Retainer Tine & GRS72 Grapple	1200	ea	SFR84GRS72	\$6,180.00	\$6,296.00	\$6,412.00	\$6,559.00
92" Stone Fork Retainer Tine & GRS84 Grapple	1285	ea	SFR92GRS84	\$6,564.00	\$6,680.00	\$6,796.00	\$6,943.00
Optional 90" Hose Kit c/w Flat Faced Couplers		ea	HK90	\$324.00			
Optional 90" Hose Kit c/w 90° Flat Faced Couplers		ea	HK9090	\$324.00			
Optional Spring Hose Mount Kit		ea	SHMK	\$147.00			

Skidsteer Grapple (Popular Package Pricing)



SBLP72GRS66

- Designed for use on skidsteers with limited clearance for grapple arms
- Comes with 2½" x 8" cylinders

Low Profile Skidsteer Bucket & Skidsteer Grapple	Weight	UOM	Part #	Price Code			
	in lbs			A	B	C	D
66" Low Profile Skidsteer Bucket & GRS60 Grapple	795	ea	SBLP66GRS60	\$4,142.00	\$4,258.00	\$4,374.00	\$4,521.00
72" Low Profile Skidsteer Bucket & GRS66 Grapple	825	ea	SBLP72GRS66	\$4,191.00	\$4,307.00	\$4,423.00	\$4,570.00
84" Low Profile Skidsteer Bucket & GRS72 Grapple	900	ea	SBLP84GRS72	\$4,575.00	\$4,691.00	\$4,807.00	\$4,954.00
96" Low Profile Skidsteer Bucket & GRS84 Grapple	985	ea	SBLP96GRS84	\$4,978.00	\$5,094.00	\$5,210.00	\$5,357.00
Optional 90" Hose Kit c/w Flat Faced Couplers		ea	HK90	\$324.00			
Optional 90" Hose Kit c/w 90° Flat Faced Couplers		ea	HK9090	\$324.00			
Optional Spring Hose Mount Kit		ea	SHMK	\$147.00			



SB72GRS66

- Designed for use on skidsteers with limited clearance for grapple arms
- Comes with 2½" x 8" cylinders

Standard Skidsteer Bucket & Skidsteer Grapple	Weight	UOM	Part #	Price Code			
	in lbs			A	B	C	D
66" RD Standard Skidsteer Bucket & GRS60 Grapple	790	ea	SB66GRS60	\$4,142.00	\$4,258.00	\$4,374.00	\$4,521.00
72" RD Standard Skidsteer Bucket & GRS66 Grapple	820	ea	SB72GRS66	\$4,191.00	\$4,307.00	\$4,423.00	\$4,570.00
84" RD Standard Skidsteer Bucket & GRS72 Grapple	900	ea	SB84GRS72	\$4,575.00	\$4,691.00	\$4,807.00	\$4,954.00
96" RD Standard Skidsteer Bucket & GRS84 Grapple	990	ea	SB96GRS84	\$4,978.00	\$5,094.00	\$5,210.00	\$5,357.00
Optional 90" Hose Kit c/w Flat Faced Couplers		ea	HK90	\$324.00			
Optional 90" Hose Kit c/w 90° Flat Faced Couplers		ea	HK9090	\$324.00			
Optional Spring Hose Mount Kit		ea	SHMK	\$147.00			

Grapples

Utility Grapple (Popular Package Pricing)



MFE66GR66

- Opens up to 70"
- Comes with 2½" x 8" cylinders

Manure Fork with Cranked Kverneland Tine & Regular Utility Grapple	Tine	Weight	UOM	Part #	Price Code			
	Centres	in lbs			A	B	C	D
66" Manure Fork Kverneland Tines & GR66 Grapple	8"	830	ea	MFE66GR66	\$4,191.00	\$4,307.00	\$4,423.00	\$4,570.00
72" Manure Fork Kverneland Tines & GR66 Grapple	8 5/8"	850	ea	MFE72GR66	\$4,295.00	\$4,411.00	\$4,527.00	\$4,674.00
84" Manure Fork Kverneland Tines & GR72 Grapple	8 1/8"	930	ea	MFE84GR72	\$4,691.00	\$4,807.00	\$4,923.00	\$5,070.00
96" Manure Fork Kverneland Tines & GR84 Grapple	7 7/8"	1020	ea	MFE96GR84	\$5,289.00	\$5,405.00	\$5,521.00	\$5,668.00
Optional 90" Hose Kit c/w Flat Faced Couplers			ea	HK90	\$324.00			
Optional 90" Hose Kit c/w 90° Flat Faced Couplers			ea	HK9090	\$324.00			
Optional Spring Hose Mount Kit			ea	SHMK	\$147.00			



SFR77GR66

- Same great features as regular & heavy duty stone forks
- Opens up to 70"
- Comes with 2½" x 8" cylinders

Regular Duty Stone Fork with Retainer Style Tine & Regular Utility Grapple	Weight	UOM	Part #	Price Code			
	in lbs			A	B	C	D
77" Stone Fork Retainer Tine & GR66 Grapple	1215	ea	SFR77GR66	\$5,564.00	\$5,680.00	\$5,796.00	\$5,943.00
84" Stone Fork Retainer Tine & GR72 Grapple	1315	ea	SFR84GR72	\$5,991.00	\$6,107.00	\$6,223.00	\$6,370.00
92" Stone Fork Retainer Tine & GR84 Grapple	1375	ea	SFR92GR84	\$6,351.00	\$6,467.00	\$6,583.00	\$6,730.00
Optional 90" Hose Kit c/w Flat Faced Couplers		ea	HK90	\$324.00			
Optional 90" Hose Kit c/w 90° Flat Faced Couplers		ea	HK9090	\$324.00			
Optional Spring Hose Mount Kit		ea	SHMK	\$147.00			

Heavy Duty Stone Fork with Retainer Style Tine & Regular Utility Grapple	Weight	UOM	Part #	Price Code			
	in lbs			A	B	C	D
77" HD Stone Fork Retainer Tine & GR66 Grapple	1795	ea	SFRH77GR66	\$6,625.00	\$6,741.00	\$6,857.00	\$7,004.00
85" HD Stone Fork Retainer Tine & GR72 Grapple	1940	ea	SFRH85GR72	\$7,101.00	\$7,217.00	\$7,333.00	\$7,480.00
90" HD Stone Fork Retainer Tine & GR84 Grapple	2030	ea	SFRH90GR84	\$7,503.00	\$7,619.00	\$7,735.00	\$7,882.00
94" HD Stone Fork Retainer Tine & GR84 Grapple	2095	ea	SFRH94GR84	\$7,790.00	\$7,906.00	\$8,022.00	\$8,169.00
Optional 90" Hose Kit c/w Flat Faced Couplers		ea	HK90	\$324.00			
Optional 90" Hose Kit c/w 90° Flat Faced Couplers		ea	HK9090	\$324.00			
Optional Spring Hose Mount Kit		ea	SHMK	\$147.00			

Utility Grapple (Popular Package Pricing)



MB72GR66

- Opens up to 70"
- Comes with 2½" x 8" cylinders

Standard Front End Loader Bucket & Regular Utility Grapple	Weight	UOM	Part #	Price Code			
	in lbs			A	B	C	D
72" RD Standard Material Bucket & GR66 Grapple	885	ea	MB72GR66	\$3,996.00	\$4,112.00	\$4,228.00	\$4,375.00
84" RD Standard Material Bucket & GR72 Grapple	955	ea	MB84GR72	\$4,386.00	\$4,502.00	\$4,618.00	\$4,765.00
96" RD Standard Material Bucket & GR84 Grapple	1050	ea	MB96GR84	\$4,765.00	\$4,881.00	\$4,997.00	\$5,144.00
Optional 90° Hose Kit c/w Flat Faced Couplers		ea	HK90	\$324.00			
Optional 90° Hose Kit c/w 90° Flat Faced Couplers		ea	HK9090	\$324.00			
Optional Spring Hose Mount Kit		ea	SHMK	\$147.00			



SB72GR66

- Opens up to 70"
- Comes with 2½" x 8" cylinders

Standard Skidsteer Bucket & Regular Utility Grapple	Weight	UOM	Part #	Price Code			
	in lbs			A	B	C	D
72" RD Standard Skidsteer Bucket & GR66 Grapple	870	ea	SB72GR66	\$3,996.00	\$4,112.00	\$4,228.00	\$4,375.00
84" RD Standard Skidsteer Bucket & GR72 Grapple	950	ea	SB84GR72	\$4,386.00	\$4,502.00	\$4,618.00	\$4,765.00
96" RD Standard Skidsteer Bucket & GR84 Grapple	1045	ea	SB96GR84	\$4,765.00	\$4,881.00	\$4,997.00	\$5,144.00
Optional 90° Hose Kit c/w Flat Faced Couplers		ea	HK90	\$324.00			
Optional 90° Hose Kit c/w 90° Flat Faced Couplers		ea	HK9090	\$324.00			
Optional Spring Hose Mount Kit		ea	SHMK	\$147.00			

Grapples



RRGLD48

- Light weight with rugged design for compact loaders
- 28" overall height when closed
- 7" centre to centre tine spacing
- Points are 1/2" thick, AR400 material
- Opens up to 33 1/2"
- Comes with 2 1/2" x 8" cylinder

Light Duty Root Rake c/w Grapple	Weight	UOM	Part #	Price Code			
				A	B	C	D
For Compact Loaders	in lbs						
48" Light Duty Root Rake c/w Grapple	365	ea	RRGLD48	\$3,093.00	\$3,209.00		
54" Light Duty Root Rake c/w Grapple	380	ea	RRGLD54	\$3,288.00	\$3,404.00		
60" Light Duty Root Rake c/w Grapple	405	ea	RRGLD60	\$3,496.00	\$3,612.00		
66" Light Duty Root Rake c/w Grapple	425	ea	RRGLD66	\$3,813.00	\$3,929.00		
Optional 90" Hose Kit c/w Flat Faced Couplers		ea	HK90	\$324.00			
Optional 90" Hose Kit c/w 90° Flat Faced Couplers		ea	HK9090	\$324.00			
Optional Spring Hose Mount Kit		ea	SHMK	\$147.00			



RRG78

- Two independent grapples for complete clamping on awkward loads
- 34" overall height when closed
- Points are 1/2" thick, AR400 material
- 7" centre to centre tine spacing
- Opens up to 48 1/2"
- Comes with 2 1/2" x 8" cylinders

Root Rake c/w Grapple	Weight	UOM	Part #	Price Code			
				A	B	C	D
	in lbs						
66" Root Rake c/w Grapple	985	ea	RRG66	\$5,240.00	\$5,356.00	\$5,472.00	\$5,619.00
78" Root Rake c/w Grapple	1070	ea	RRG78	\$5,777.00	\$5,893.00	\$6,009.00	\$6,156.00
88" Root Rake c/w Grapple	1125	ea	RRG88	\$6,314.00	\$6,430.00	\$6,546.00	\$6,693.00
96" Root Rake c/w Grapple	1200	ea	RRG96	\$6,851.00	\$6,967.00	\$7,083.00	\$7,230.00
Optional 90" Hose Kit c/w Flat Faced Couplers		ea	HK90	\$324.00			
Optional 90" Hose Kit c/w 90° Flat Faced Couplers		ea	HK9090	\$324.00			
Optional Spring Hose Mount Kit		ea	SHMK	\$147.00			



BRGC48

- Opens to 38" wide from ground to point of grapple
- Tine tips and grapple tips are AR400 material
- Tine spacing 6" on center
- Single grapple arm
- 28" overall height
- 33" overall depth
- Comes with 2½" x 8" cylinder

Compact Brush Grapple	Weight	UOM	Part #	Price Code			
	in lbs			A	B	C	D
48" Compact Brush Grapple	405	ea	BRGC48	\$2,611.00	\$2,727.00	\$2,843.00	\$2,990.00
54" Compact Brush Grapple	420	ea	BRGC54	\$2,861.00	\$2,977.00	\$3,093.00	\$3,240.00
60" Compact Brush Grapple	440	ea	BRGC60	\$3,111.00	\$3,227.00	\$3,343.00	\$3,490.00
66" Compact Brush Grapple	455	ea	BRGC66	\$3,386.00	\$3,502.00	\$3,618.00	\$3,765.00
Optional 90" Hose Kit c/w Flat Faced Couplers		ea	HK90	\$324.00			
Optional 90" Hose Kit c/w 90° Flat Faced Couplers		ea	HK9090	\$324.00			
Optional Spring Hose Mount Kit		ea	SHMK	\$147.00			



BRG72

- Opens to 48" wide from ground to point of grapple
- Tine tips and grapple tips are AR400 material
- Tine spacing 5.5" between
- Independent grapples for clamping of awkward loads
- Comes with 2½" x 8" cylinders

Brush Grapple	Weight	UOM	Part #	Price Code			
	in lbs			A	B	C	D
66" Brush Grapple	830	ea	BRG66	\$4,399.00	\$4,515.00	\$4,631.00	\$4,778.00
72" Brush Grapple	865	ea	BRG72	\$4,795.00	\$4,911.00	\$5,027.00	\$5,174.00
84" Brush Grapple	930	ea	BRG84	\$5,210.00	\$5,326.00	\$5,442.00	\$5,589.00
96" Brush Grapple	1005	ea	BRG96	\$5,625.00	\$5,741.00	\$5,857.00	\$6,004.00
Optional 90" Hose Kit c/w Flat Faced Couplers		ea	HK90	\$324.00			
Optional 90" Hose Kit c/w 90° Flat Faced Couplers		ea	HK9090	\$324.00			
Optional Spring Hose Mount Kit		ea	SHMK	\$147.00			

Dirt Blades



DB84 with standard power tilt

- Ideal for skidsteers and front end loaders
- Heavy duty construction with two angle cylinders
- Reversible cutting edge
- 24" high mouldboard
- **Standard:** Blade oscillates 5° hydraulically either way for side levelling (Includes electric selector valve)
- Bolt-on skid shoes
- 35° hydraulic angle left and right

Heavy Duty 6-Way Dirt Blade	Weight	Part #	Price Code			
	in lbs		A	B	C	D
72" Dirt Blade c/w Power Tilt	1115	DB72	\$5,899.00	\$6,015.00	\$6,131.00	\$6,278.00
84" Dirt Blade c/w Power Tilt	1175	DB84	\$6,454.00	\$6,570.00	\$6,686.00	\$6,833.00
96" Dirt Blade c/w Power Tilt	1220	DB96	\$7,003.00	\$7,119.00	\$7,235.00	\$7,382.00
Optional 90" Hose Kit c/w Flat Faced Couplers		HK90	\$324.00			
Optional Spring Hose Mount Kit		SHMK	\$147.00			
For complete price add Wire Kit price to DB of choice						

Wire Kit for Dirt Blade - Must choose 1	Part #	Price
Complete Single Diverter Wire Kit w/ 2 Way Switch	WKDV1	\$568.00
OEM Connection Wire Kit (See Info on Page 57)		

Skidsteer Grader



GB84

- Push-pull design for grading in forward or reverse
- Pneumatic swivel wheels with tapered roller bearings on king pins, on oscillating front axle
- Tapered roller bearings on axle oscillation pivot
- Removable shims on main oscillation pivot to keep wear joint tight
- Two 2 1/2" x 6" cylinders provide cross-slope operation
- Reversible cutting edges
- Universal laser mast mount
- Levels consistently within 1/4" of target grade
- Control valve included, does not include laser or grade control electronics

Skidsteer Laser Grader	Weight	UOM	Part #	Price
Skidsteer Laser Grader	1610 lbs	ea	SLG84	\$28,567.00
Optional 90" Hose Kit c/w Flat Faced Couplers			HK90	\$324.00
Optional Spring Hose Mount Kit			SHMK	\$147.00

Brooms - Hydraulic Rotary



BRB84

- Ideal for cleaning up parking lots, construction sites, streets, curbs and gutters as well as parks and recreation areas etc.
- Includes hydraulic hoses and flat-faced couplers
- 26" diameter poly/steel bristle wafers
- Direct motor drive on broom
- Hydraulic requirements: 12-20 GPM @ 1500 - 3000 PSI
- Front gauge wheel
- Reversible broom rotation for sweeping away from doors etc.
- Bucket features a replaceable hardened 3/4 x 6 double bevel cutting edge
- Optional dust suppression water kit available

Hydraulic Rotary Pick-up Broom	Capacity	Weight	UOM	Part #	Price Code			
	cu ft	in lbs			A	B	C	D
For mounts other than standard skidsteer please order		150	ea	BOQBK	\$330.00	\$446.00	\$562.00	\$709.00
60" Wide Pick-up Broom	13.7	1045	ea	BRB60BO500	\$10,139.00			
72" Wide Pick-up Broom	16.4	1165	ea	BRB72BO500	\$10,535.00			
84" Wide Pick-up Broom	19.2	1255	ea	BRB84BO500	\$11,255.00			
96" Wide Pick-up Broom	21.9	1410	ea	BRB96BO500	\$11,883.00			

Brooms - Hydraulic Rotary

BROOMS -
HYDRAULIC ROTARY



BR72

- Unique lateral and forward float
- Gauge wheels
- Includes hydraulic hoses and flat-faced couplers
- 26" diameter poly/steel bristle wafers
- Hydraulic angle 30° right and left
- Direct motor drive on broom
- Hydraulic requirements: 12-20 GPM @ 1500 - 3000 PSI
- Optional OEM connection wire kit
- Equipped with 50/50 poly steel bristles (optional all poly)
- Optional Kit to reverse broom rotation for sweeping away from doors etc.
- Optional dust suppression water kit available

Hydraulic Rotary Broom	Weight in lbs	UOM	Part #	Price Code			
				A	B	C	D
60" Wide Broom	1040	ea	BR60	\$10,547.00	\$10,663.00	\$10,779.00	\$10,926.00
72" Wide Broom	1075	ea	BR72	\$11,420.00	\$11,536.00	\$11,652.00	\$11,799.00
84" Wide Broom	1110	ea	BR84	\$11,944.00	\$12,060.00	\$12,176.00	\$12,323.00
96" Wide Broom	1145	ea	BR96	\$12,695.00	\$12,811.00	\$12,927.00	\$13,074.00
Optional Reversing Kit for BR Series		ea	BRORK	\$1,062.00			

For complete price add Standard Wire Kit or OEM Wire Kit price to Broom of choice

Wire Kit for Broom - Must choose 1	UOM	Part #	Price
Wire Kit for Broom c/w Hand Held Control	ea	WKDVBR	\$928.00
OEM Connection Wire Kit (See Info below)			

Optional OEM Connection Wire Kit	UOM	Part #	Price
ASV Skidsteer 8 Pin HLA Broom Wire Kit	ea	EWKBR8CAT	\$495.00
Bobcat Skidsteer 14 Pin HLA Broom Wire Kit	ea	EWKBR14BO	\$495.00
Bobcat Skidsteer 7 Pin HLA Broom Wire Kit	ea	EWKBR7BO	\$2,605.00
Case Skidsteer 14 Pin HLA Broom Wire Kit	ea	EWKBR14CNH	\$495.00
Caterpillar Skidsteer 14 Pin HLA Broom Wire Kit	ea	EWKBR14CAT	\$495.00
Caterpillar Skidsteer 8 Pin HLA Broom Wire Kit	ea	EWKBR8CAT	\$495.00
Gehl Skidsteer 14 Pin HLA Broom Wire Kit	ea	EWKBR14CAT	\$495.00
JCB Skidsteer 14 Pin HLA Broom Wire Kit	ea	EWKBR14KU	\$495.00
John Deere Skidsteer 14 Pin HLA Broom Wire Kit	ea	EWKBR14JD	\$495.00
Kubota Skidsteer 14 Pin HLA Broom Wire Kit	ea	EWKBR14KU	\$495.00
New Holland Skidsteer 14 Pin HLA Broom Wire Kit	ea	EWKBR14CNH	\$495.00
Takeuchi Skidsteer 14 Pin HLA Broom Wire Kit	ea	EWKBR14TA	\$495.00
Volvo Skidsteer 14 Pin HLA Broom Wire Kit	ea	EWKBR14KU	\$495.00
Wacker Neuson Skidsteer 14 Pin HLA Broom Wire Kit	ea	EWKBR14KU	\$495.00
Call for makes or models not listed			
Replacement Wafer Set			
60" Broom 50/50 Wafer Set (14 Steel/15 Poly)	ea	LP102667	\$1,050.00
72" Broom 50/50 Wafer Set (18 Steel/19 Poly)	ea	LP100313	\$1,336.00
84" Broom 50/50 Wafer Set (21 Steel/22 Poly)	ea	LP100303	\$1,544.00
96" Broom 50/50 Wafer Set (23 Steel/24 Poly)	ea	LP102134	\$1,684.00



BRBWK

- 25 gal tank
- 12 volt electric pump
- 1 wide angle spray nozzle
- Easy infield installation

Dust Suppression Water Kit for Hydraulic Rotary Brooms	Weight	UOM	Part #	Price
Water Kit c/w Spray Nozzle BRB Series	50 lbs	ea	BRBWK	\$1,849.00
Water Kit c/w Spray Nozzle BR Series	50 lbs	ea	BRWK	\$1,849.00
Factory install of water kit				\$196.00

Miscellaneous Attachments



- Adapter attaches to loader then allows you to hook up to three point hitch equipment
- Bottom two arms slide for easy hook-up
- Comes with Reese hitch receiver
- Fits CAT 2, three point hitch

3PHA

Three Point Hitch Adapter	Weight	UOM	Part #	Price Code			
	in lbs			A	B	C	D
Three Point Hitch Adapter	225	ea	3PHA	\$1,013.00	\$1,129.00	\$1,245.00	\$1,392.00



- 2" Receiver
- Ideal for moving light trailers around the yard
- Ball hitch mount on top of frame for moving goose neck trailer
- Max gross trailer weight 9000 lbs
- Max tongue weight 800 lbs

TH2

Trailer Hitch 2" Receiver	Weight	UOM	Part #	Price Code			
	in lbs			A	B	C	D
2" Receiver	165	ea	TH2	\$806.00	\$922.00	\$1,038.00	\$1,185.00



- Adds a hydraulic PTO and three point hitch to any skidsteer
- Ideal for brush cutters & snow blowers etc.
- CAT 1 & 2 compatible
- Complete with adjustable top link
- **Includes high flow hose & coupler kit**
- 4000 lbs capacity
- 2" receiver included

PTORF

PTO Adapter Three Point Hitch	Weight	HP	GPM	UOM	Part #	Price Code			
	in lbs					A	B	C	D
Three Point Hitch Skidsteer PTO Adapter High Flow	440	50-60	30-40	ea	PTOHF	\$5,100.00			
Three Point Hitch Skidsteer PTO Adapter Regular Flow	440	20-25	20-25	ea	PTORF	\$5,100.00			



- Mounts between skidsteers and buckets with a universal hitch
- Hydraulic tilt 18° left and right
- 5500 lbs capacity

TAUN

Tilt Attachment	Weight	UOM	Part #	Price
Universal Tilt Attachment	425 lbs	ea	TAUN	\$5,094.00

MISCELLANEOUS ATTACHMENTS

Miscellaneous Attachments

MISCELLANEOUS ATTACHMENTS



BH600 & SHB12

- QTach to most skidsteer loaders
- 6 ft digging depth
- Hydraulic swing cylinder with 140° swing
- Single electric selector valve with universal electro-hydraulic harness kit. 12V or 24V coils available.
- Second boom mount on side of frame for digging along side foundations etc.

Choose bucket size and add to backhoe to achieve correct pricing.

Backhoe - Big Arm Skidsteer	Weight in lbs	UOM	Part #	Price Code			
				A	B	C	D
Backhoe - Less Bucket	595	ea	BH600	\$5,277.00			
Optional 90° Hose Kit c/w Flat Faced Couplers		ea	HK90	\$324.00			
Optional Spring Hose Mount Kit		ea	SHMK	\$147.00			
For complete price add Wire Kit price to BH600 & Bucket							

Wire Kit for Big Arm - Must choose 1	Part #	Price
Complete Single Diverter Wire Kit w/ Momentary Switch	WKDVBA1	\$568.00
OEM Connection Wire Kit (See Info on Page 57)		

Buckets - Big Arm Skidsteer	Weight	UOM	Part #	Price
9" Bucket for Big Arm Backhoe c/w Three Teeth	110 lbs	ea	SHBT09	\$934.00
12" Bucket for Big Arm Backhoe c/w Three Teeth	125 lbs	ea	SHBT12	\$995.00
15" Bucket for Big Arm Backhoe c/w Four Teeth	145 lbs	ea	SHBT15	\$1,062.00
18" Bucket for Big Arm Backhoe c/w Four Teeth	160 lbs	ea	SHBT18	\$1,147.00
20" Bucket for Big Arm Backhoe c/w Four Teeth	170 lbs	ea	SHBT20	\$1,214.00
9" Bucket for Big Arm Backhoe Less Teeth	110 lbs	ea	SHB09	\$818.00
12" Bucket for Big Arm Backhoe Less Teeth	120 lbs	ea	SHB12	\$897.00
15" Bucket for Big Arm Backhoe Less Teeth	135 lbs	ea	SHB15	\$964.00
18" Bucket for Big Arm Backhoe Less Teeth	150 lbs	ea	SHB18	\$1,031.00
20" Bucket for Big Arm Backhoe Less Teeth	160 lbs	ea	SHB20	\$1,086.00



BH600TH

- Bolts on to Big Arm Backhoe
- Three working positions
- Pins up against backhoe arm when not in use
- Approximate weight: 78 lbs

Optional Thumb for Big Arm Backhoe	UOM	Part #	Price
Optional Thumb for Big Arm Backhoe	ea	BH600TH	\$873.00



HLS1224

- Cut tree limbs from the safety of your skidsteer or tractor
- Automatic chain oiler
- Standard Stihl 25" guide bar and saw chain for easy replacement
- Up to 14' reach with spring tension cut assist
- Requires 15 GPM @ 3000 PSI
- RPM: 2550 @ 15 GPM
- Power: 22 hp
- Torque: 45 ft-lb

Hydraulic Limb Saw	Weight in lbs	UOM	Part #	Price Code			
				A	B	C	D
Hydraulic Limb Saw (up to 14' reach / 25" blade)	395	ea	HLS1224	\$5,033.00	\$5,149.00	\$5,265.00	\$5,412.00
Optional 90° Hose Kit c/w Flat Faced Couplers		ea	HK90	\$324.00			

Miscellaneous Attachments



- Ideal for removing concrete on sidewalks, driveways and construction sites
- Three heavy-duty shanks with replaceable points and rubberized flex pins
- Optional hydraulic thumb for increased versatility

CSB (shown with optional thumb)

Concrete Slab Lifter Bucket	Weight	UOM	Part #	Price
Concrete Slab Lifter Bucket w/o Thumb	625	ea	CSB	\$3,648.00
Optional Thumb for Concrete Slab Lifter Bucket	45	ea	CSBTH	\$1,391.00
Optional 90" Hose Kit c/w Flat Faced Couplers		ea	HK90	\$324.00



- Reduces back breaking manual labour
- Transports and cleans up easily
- Hauls up to 13 cu. ft. of concrete
- Eliminates the need for a wheelbarrow
- Works great in tight areas
- Attaches to most skidsteers
- Easy to attach and use
- 19" deep x 36" long
- 12" x 12" discharge opening

CFSB60

Concrete Funnel Bucket	Inside Width	Struck Cap - Level		Part #	Price Code			
		cu ft	in lbs		A	B	C	D
48" Concrete Funnel Bucket	48"	13.5	475	CFSB48	\$2,434.00	\$2,550.00	\$2,666.00	\$2,813.00
60" Concrete Funnel Bucket	60"	17.5	535	CFSB60	\$2,495.00	\$2,611.00	\$2,727.00	\$2,874.00
72" Concrete Funnel Bucket	72"	20.8	590	CFSB72	\$2,892.00	\$3,008.00	\$3,124.00	\$3,271.00
78" Concrete Funnel Bucket	78"	22.3	650	CFSB78	\$3,160.00	\$3,276.00	\$3,392.00	\$3,539.00

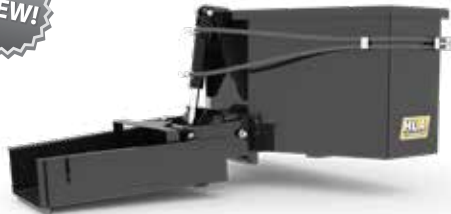

- Reduces back breaking manual labour
- Hauls up to 15 cu. ft. of concrete
- Eliminates the need for a wheelbarrow
- Works great in tight areas
- Attaches to most skidsteers
- Easy to attach and use
- Outside hopper dimensions 55" wide, 25" long, 23" high
- 30" long swinging discharge chute
- 13" x 5" discharge opening
- Hydraulic discharge gate control

CHB54

Concrete Hopper Bucket	Inside Width	Struck Cap - Level		Part #	Price Code			
		cu ft	in lbs		A	B	C	D
54" Concrete Hopper Bucket	54"	14.5	490	CHB54	\$4,033.00	\$4,149.00	\$4,265.00	\$4,412.00
Optional 90" Hose Kit c/w Flat Faced Couplers				HK90	\$324.00			
Optional 90" Hose Kit c/w 90° Flat Faced Couplers				HK9090	\$324.00			
Optional Spring Hose Mount Kit				SHMK	\$147.00			



3PHC2WB838

- Comes with cross bar for quick-hitch system
- Bolt-on top lid for ease of filling
- 5 cu. ft. CAT 1 or 2
- 8.38 cu. ft. CAT 2

Three Point Hitch Weight Box	Weight	UOM	Part #	Price
Weight Box CAT 1 - 5 cu ft	215 lbs	ea	3PHC1WB500	\$1,434.00
Weight Box CAT 2 - 5 cu ft	215 lbs	ea	3PHC2WB500	\$1,434.00
Weight Box CAT 2 - 8.38 cu ft	360 lbs	ea	3PHC2WB838	\$1,879.00

MISCELLANEOUS ATTACHMENTS



- 1 3/16" x 3 1/8" Class II hook type solid fork lift tines
- 900 lbs capacity @ 21" L.C.
- Sliding adjustable
- Tines can be locked in any position
- 50" wide carriage

HD0936

Light Duty Pallet Fork	Tine Length	Weight	Part #	Price Code			
900 LB Capacity		in lbs		A	B	C	D
Light Duty Pallet Fork c/w Tines	36"	190	HD0936	\$909.00	\$1,025.00	\$1,141.00	
Light Duty Pallet Fork c/w Tines	42"	205	HD0942	\$934.00	\$1,050.00	\$1,166.00	
Light Duty Pallet Fork c/w Tines	48"	215	HD0948	\$983.00	\$1,099.00	\$1,215.00	
Carriage Only Less Tines			HD09	\$580.00	\$696.00	\$812.00	



- 1 3/16" x 3 1/8" Class II hook type solid fork lift tines
- 1200 lbs capacity @ 24" L.C.
- Sliding adjustable
- Tines can be locked in any position
- 50" wide carriage

HD1242

Light Duty Pallet Fork	Tine Length	Weight	Part #	Price Code			
1200 LB Capacity		in lbs		A	B	C	D
Light Duty Pallet Fork c/w Tines	36"	285	HD1236	\$989.00	\$1,105.00	\$1,221.00	
Light Duty Pallet Fork c/w Tines	42"	315	HD1242	\$1,013.00	\$1,129.00	\$1,245.00	
Light Duty Pallet Fork c/w Tines	48"	325	HD1248	\$1,062.00	\$1,178.00	\$1,294.00	
Carriage Only Less Tines			HD12	\$659.00	\$775.00	\$891.00	



- 1 1/2" x 3 1/8" Class II hook type solid fork lift tines
- 2000 lbs capacity @ 24" L.C.
- C/w guard
- 50" wide carriage

HD2042

Heavy Duty Pallet Fork	Tine Length	Weight	Part #	Price Code			
2000 LB Capacity		in lbs		A	B	C	D
Heavy Duty Pallet Fork c/w Guard - Tines	36"	310	HD2036	\$1,135.00	\$1,251.00	\$1,367.00	
Heavy Duty Pallet Fork c/w Guard - Tines	42"	340	HD2042	\$1,172.00	\$1,288.00	\$1,404.00	
Heavy Duty Pallet Fork c/w Guard - Tines	48"	350	HD2048	\$1,184.00	\$1,300.00	\$1,416.00	
Carriage Only c/w Guard Less Tines			HD20	\$684.00	\$800.00	\$916.00	

Pallet Forks



HD4248

- 1-3/8" x 4" Class II hook type solid fork lift tines
- 4200 lbs capacity @ 20" L.C.
- C/w guard
- 50" wide carriage
- Sliding adjustable
- Tines can be locked in any position

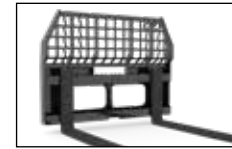

Full Back Guard Option (Brick Guard)

HD42BG - add \$171.00

Heavy Duty Pallet Fork	Tine Length	Weight	Part #	Price Code			
				A	B	C	D
4200 LB Capacity		in lbs					
Heavy Duty Pallet Fork c/w Guard - Tines	42"	405	HD4242	\$1,306.00	\$1,422.00	\$1,538.00	\$1,685.00
Heavy Duty Pallet Fork c/w Guard - Tines	48"	425	HD4248	\$1,367.00	\$1,483.00	\$1,599.00	\$1,746.00
Carriage Only c/w Guard Less Tines			HD42	\$720.00	\$836.00	\$952.00	\$1,099.00

PALLET FORKS



HD5548

- 1½" x 4" Class II hook type solid fork lift tines
- 5500 lbs capacity @24" L.C.
- C/w guard
- 50" wide carriage
- Sliding adjustable
- Tines can be locked in any position



Full Back Guard Option (Brick Guard)

HD55BG - add \$202.00

Heavy Duty Pallet Fork	Tine Length	Weight	Part #	Price Code			
				A	B	C	D
5500 LB Capacity		in lbs					
Heavy Duty Pallet Fork c/w Guard - Tines	42"	455	HD5542	\$1,532.00	\$1,648.00	\$1,764.00	\$1,911.00
Heavy Duty Pallet Fork c/w Guard - Tines	48"	480	HD5548	\$1,593.00	\$1,709.00	\$1,825.00	\$1,972.00
Heavy Duty Pallet Fork c/w Guard - Tines	54"	495	HD5554	\$1,776.00	\$1,892.00	\$2,008.00	\$2,155.00
Heavy Duty Pallet Fork c/w Guard - Tines	60"	515	HD5560	\$2,032.00	\$2,148.00	\$2,264.00	\$2,411.00
Heavy Duty Pallet Fork c/w Guard - Tines	72"	570	HD5572	\$2,666.00	\$2,782.00	\$2,898.00	\$3,045.00
Carriage Only c/w Guard Less Tines			HD55	\$922.00	\$1,038.00	\$1,154.00	\$1,301.00



HD7548

- 1¾" x 5" Class III hook type solid fork lift tines
- 7500 lbs capacity @ 24" L.C.
- C/w guard
- 50" wide carriage
- Sliding adjustable
- Tines can be locked in any position



Full Back Guard Option (Brick Guard)

HD75BG - add \$476.00

Heavy Duty Pallet Fork	Tine Length	Weight	Part #	Price Code			
				A	B	C	D
7500 LB Capacity		in lbs					
Heavy Duty Pallet Fork c/w Guard - Tines	48"	590	HD7548	\$2,599.00	\$2,715.00	\$2,831.00	\$2,978.00
Heavy Duty Pallet Fork c/w Guard - Tines	54"	620	HD7554	\$2,794.00	\$2,910.00	\$3,026.00	\$3,173.00
Heavy Duty Pallet Fork c/w Guard - Tines	60"	650	HD7560	\$3,209.00	\$3,325.00	\$3,441.00	\$3,588.00
Heavy Duty Pallet Fork c/w Guard - Tines	72"	730	HD7572	\$3,355.00	\$3,471.00	\$3,587.00	\$3,734.00
Carriage Only c/w Guard Less Tines			HD75	\$1,123.00	\$1,239.00	\$1,355.00	\$1,502.00



HD10048

- 2" x 6" Class III hook type solid fork lift tines
- 10,000 lbs capacity @ 24" L.C.
- C/w guard
- Sliding adjustable
- Tines can be locked in any position
- 50" wide carriage

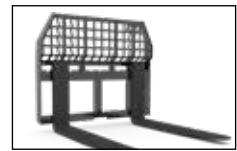

Full Back Guard Option (Brick Guard)

HD100BG - add \$476.00

Heavy Duty Pallet Fork 10,000 LB Capacity	Tine Length	Weight in lbs	Part #	Price Code			
				A	B	C	D
Heavy Duty Pallet Fork c/w Guard - Tines	48"	690	HD10048	\$3,368.00	\$3,484.00	\$3,600.00	\$3,747.00
Heavy Duty Pallet Fork c/w Guard - Tines	54"	735	HD10054	\$3,599.00	\$3,715.00	\$3,831.00	\$3,978.00
Heavy Duty Pallet Fork c/w Guard - Tines	60"	770	HD10060	\$3,819.00	\$3,935.00	\$4,051.00	\$4,198.00
Heavy Duty Pallet Fork c/w Guard - Tines	72"	840	HD10072	\$4,893.00	\$5,009.00	\$5,125.00	\$5,272.00
Carriage Only c/w Guard Less Tines			HD100	\$1,586.00	\$1,702.00	\$1,818.00	\$1,965.00



HDR5548

- Rotation is powered by a cylinder for smooth and contoured operation
- Adjustable tines
- Rotates 180° for a full dump to the left

Rotating Pallet Fork	Tine Length	Weight in lbs	Part #	Price Code			
				A	B	C	D
2000 lbs Rotating Pallet Fork	42"	815	HDR2042	\$4,447.00	\$4,563.00	\$4,679.00	\$4,826.00
4200 lbs Rotating Pallet Fork	42"	825	HDR4242	\$5,966.00	\$6,082.00	\$6,198.00	\$6,345.00
4200 lbs Rotating Pallet Fork	48"	840	HDR4248	\$6,027.00	\$6,143.00	\$6,259.00	\$6,406.00
5500 lbs Rotating Pallet Fork	42"	840	HDR5542	\$6,540.00	\$6,656.00	\$6,772.00	\$6,919.00
5500 lbs Rotating Pallet Fork	48"	860	HDR5548	\$6,601.00	\$6,717.00	\$6,833.00	\$6,980.00
5500 lbs Rotating Pallet Fork	54"	880	HDR5554	\$6,784.00	\$6,900.00	\$7,016.00	\$7,163.00
2000 lbs Carriage Only Less Tines			HDR20	\$3,959.00	\$4,075.00	\$4,191.00	\$4,338.00
4200 lbs Carriage Only Less Tines			HDR42	\$5,381.00	\$5,497.00	\$5,613.00	\$5,760.00
5500 lbs Carriage Only Less Tines			HDR55	\$5,930.00	\$6,046.00	\$6,162.00	\$6,309.00
Optional 90" Hose Kit c/w Flat Faced Couplers			HK90	\$324.00			
Optional Spring Hose Mount Kit			SHMK	\$147.00			



HDO5542

- Rotation is powered by a cylinder for smooth operation
- Adjustable tines
- Levels 45 degrees each way
- Great for uneven job sites

Power Tilting Pallet Fork	Tine Length	Weight in lbs	Part #	Price Code			
				A	B	C	D
5500 lbs Power Tilting Pallet Fork	42"	750	HDO5542	\$7,388.00	\$7,504.00	\$7,620.00	\$7,767.00
5500 lbs Power Tilting Pallet Fork	48"	770	HDO5548	\$7,449.00	\$7,565.00	\$7,681.00	\$7,828.00
5500 lbs Power Tilting Pallet Fork	54"	790	HDO5554	\$7,632.00	\$7,748.00	\$7,864.00	\$8,011.00
7500 lbs Power Tilting Pallet Fork	48"	940	HDO7548	\$8,431.00	\$8,547.00	\$8,663.00	\$8,810.00
7500 lbs Power Tilting Pallet Fork	54"	970	HDO7554	\$8,626.00	\$8,742.00	\$8,858.00	\$9,005.00
5500 lbs Carriage Only Less Tines			HDO55	\$6,778.00	\$6,894.00	\$7,010.00	\$7,157.00
7500 lbs Carriage Only Less Tines			HDO75	\$6,954.00	\$7,070.00	\$7,186.00	\$7,333.00
Optional 90" Hose Kit c/w Flat Faced Couplers			HK90	\$324.00			
Optional Spring Hose Mount Kit			SHMK	\$147.00			

Pallet Forks



- Hydraulic carriage side shift
- 16" travel (8" right or left)
- Adjustable tines

HDS5548

Side Shift Pallet Fork	Tine Length	Weight in lbs	Part #	Price Code			
				A	B	C	D
4200 lbs Side Shift Pallet Fork	42"	730	HDS4242	\$3,776.00	\$3,892.00	\$4,008.00	\$4,155.00
4200 lbs Side Shift Pallet Fork	48"	750	HDS4248	\$3,837.00	\$3,953.00	\$4,069.00	\$4,216.00
5500 lbs Side Shift Pallet Fork	42"	750	HDS5542	\$4,014.00	\$4,130.00	\$4,246.00	\$4,393.00
5500 lbs Side Shift Pallet Fork	48"	770	HDS5548	\$4,075.00	\$4,191.00	\$4,307.00	\$4,454.00
5500 lbs Side Shift Pallet Fork	54"	790	HDS5554	\$4,258.00	\$4,374.00	\$4,490.00	\$4,637.00
4200 lbs Carriage Only Less Tines			HDS42	\$3,191.00	\$3,307.00	\$3,423.00	\$3,570.00
5500 lbs Carriage Only Less Tines			HDS55	\$3,404.00	\$3,520.00	\$3,636.00	\$3,783.00
Optional 90" Hose Kit c/w Flat Faced Couplers			HK90	\$324.00			
Optional Spring Hose Mount Kit			SHMK	\$147.00			

PALLET FORKS



- Hydraulic sliding tines
- Ideal for clamping (Such as a root ball in nurseries etc.)
- Hydraulic powered tines move in and out equally

HDN7554

Power Tine Pallet Fork	Tine Length	Weight in lbs	Part #	Price Code			
				A	B	C	D
4200 lbs Power Tine Pallet Fork	42"	680	HDN4242	\$3,862.00	\$3,978.00	\$4,094.00	\$4,241.00
4200 lbs Power Tine Pallet Fork	48"	700	HDN4248	\$3,929.00	\$4,045.00	\$4,161.00	\$4,308.00
5500 lbs Power Tine Pallet Fork	42"	680	HDN5542	\$4,081.00	\$4,197.00	\$4,313.00	\$4,460.00
5500 lbs Power Tine Pallet Fork	48"	700	HDN5548	\$4,142.00	\$4,258.00	\$4,374.00	\$4,521.00
5500 lbs Power Tine Pallet Fork	54"	720	HDN5554	\$4,179.00	\$4,295.00	\$4,411.00	\$4,558.00
7500 lbs Power Tine Pallet Fork	48"	810	HDN7548	\$6,137.00	\$6,253.00	\$6,369.00	\$6,516.00
7500 lbs Power Tine Pallet Fork	54"	840	HDN7554	\$6,326.00	\$6,442.00	\$6,558.00	\$6,705.00
7500 lbs Power Tine Pallet Fork	60"	865	HDN7560	\$6,954.00	\$7,070.00	\$7,186.00	\$7,333.00
Optional 90" Hose Kit c/w Flat Faced Couplers			HK90	\$324.00			
Optional Spring Hose Mount Kit			SHMK	\$147.00			

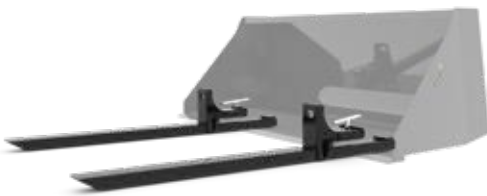

- Adaptable to most buckets
- No tools or bolts needed

BFT6544 (bucket not included)

Bucket Pallet Fork	Size	Weight	UOM	Part #	Price
1000 LB Bucket Pallet Fork c/w Hardware	3" x 2" x 32" Long	78 lbs	set	BFT3532	\$610.00
2000 LB Bucket Pallet Fork c/w Hardware	4" x 2" x 44" Long	143 lbs	set	BFT6544	\$781.00

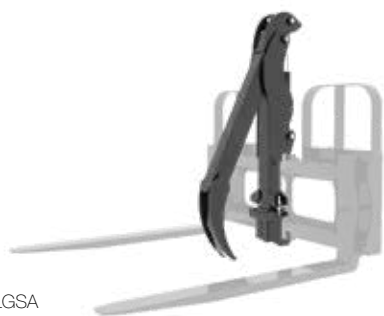

LGSA

- Removable log grapple for pallet forks
- Clamps onto Class II or III fork frame (walk through guards only)
- C/w Hydraulic cylinder

Single Arm Log Grapple	Weight	Part #	Price
	in lbs		
Single Arm Log Grapple To Fit Class II Rail (HD20, HD42, HD55)	195	LGSA	\$1,690.00
Single Arm Log Grapple To Fit Class III Rail (HD75, HD100)	205	LGSAC3	\$1,971.00



LG5542

- Grapple version of HD55/HD75 pallet fork
- 42" solid fork lift tines
- 5500/7500 lbs capacity
- C/w HD Cylinders

Log Grapple	Weight in lbs	Part #	Price Code			
			A	B	C	D
Log Grapple Mounted On HD55 Pallet Fork c/w Cylinders & 42" Tines	800	LG5542	\$3,837.00	\$3,953.00	\$4,069.00	\$4,216.00
Log Grapple Mounted On HD55 Pallet Fork c/w Cylinders & 48" Tines	820	LG5548	\$3,898.00	\$4,014.00	\$4,130.00	\$4,277.00
Log Grapple Mounted On HD75 Pallet Fork c/w Cylinders & 48" Tines	1030	LG7548	\$5,881.00	\$5,997.00	\$6,113.00	\$6,260.00
Log Grapple Mounted On HD75 Pallet Fork c/w Cylinders & 54" Tines	1060	LG7554	\$6,076.00	\$6,192.00	\$6,308.00	\$6,455.00
Optional Mesh Guard		LGGU	\$592.00			
Optional 90" Hose Kit c/w Flat Faced Couplers		HK90	\$324.00			
Optional Spring Hose Mount Kit		SHMK	\$147.00			



HDEX6 (fork not included)



HDNEX6 (fork not included)

Standard Extensions

- Fits HD42 & HD55 forks

Nursery extensions

- With angle pad for gentle clamping of root balls, etc
- NOTE: Tine extensions reduce the capacity of your pallet fork

Pallet Fork Tine Extensions	Weight	UOM	Part #	Price
6' Standard Pallet Fork Tine Extensions	181 lbs	set	HDEX6	\$903.00
8' Standard Pallet Fork Tine Extensions	238 lbs	set	HDEX8	\$1,208.00
6' Nursery Pallet Fork Tine Extensions	210 lbs	set	HDNEX6	\$891.00
7' Nursery Pallet Fork Tine Extensions	244 lbs	set	HDNEX7	\$1,037.00

Side Discharge Buckets



SST84

- **Minimum 12 GPM required**
- Hydraulic drive (coupled direct)
- Agitator prevents material bridging
- Secondary metering drum regulates flow onto the belt
- Mesh in back panel for increased visibility
- 12" wide high abrasion rubber belt with 1 1/2" paddles
- Discharge from either side of machine
- Conveyor assembly removable for accessibility
- Bolted adaptation for loader quick-tach. Easily convert to most loaders
- 59"H x 58"L outside dimensions

For Outside Width add 1-1/4" to Inside Width dimension

Side Discharge Straw/Lime Bucket	Inside Width	Heaped Capacity	Weight	Part #	Price Code			
					Approx	in lbs	A	B
72" Side Discharge - Straw/Lime	72"	2 cu yd	1365	SST72	\$11,786.00	\$11,902.00	\$12,018.00	\$12,165.00
84" Side Discharge - Straw/Lime	84"	2-1/3 cu yd	1535	SST84	\$13,018.00	\$13,134.00	\$13,250.00	\$13,397.00
96" Side Discharge - Straw/Lime	96"	2-3/4 cu yd	1700	SST96	\$14,256.00	\$14,372.00	\$14,488.00	\$14,635.00
Optional Agitator Speed Control Valve - Factory Installed Only				LP102468	\$1,904.00			
Optional 90" Hose Kit c/w Flat Faced Couplers				HK90	\$324.00			
Optional 90" Hose Kit c/w 90° Flat Faced Couplers				HK9090	\$324.00			
Optional Spring Hose Mount Kit				SHMK	\$147.00			
CAT 2 Three Point Hitch Mount c/w Tilting Cylinder				Price Code A +	\$1,361.00			

SIDE DISCHARGE BUCKETS



SS72

- **Minimum 12 GPM required**
- Hydraulic drive (coupled direct)
- Beater to prevent bridging
- Discharge from either side of machine
- 44"H x 57"L outside dimensions
- Two hydraulic motors on discharge belt (72", 84" & 96" only)
- Bolted adaptation for loader quick-tach. Easily convert to most loaders

For Outside Width add 2-1/2" to Inside Width dimension.

Side Discharge Sawdust Bucket	Inside Width	Heaped Capacity	Weight	Part #	Price Code			
					Approx	in lbs	A	B
60" Side Discharge (chevron belt)	60"	1-1/2 cu yd	1020	SS60	\$8,223.00	\$8,339.00	\$8,455.00	\$8,602.00
60" Side Discharge (3/4" cleated belt)	60"	1-1/2 cu yd	1020	SSC60	\$8,730.00	\$8,846.00	\$8,962.00	\$9,109.00
72" Side Discharge (chevron belt)	72"	1-7/8 cu yd	1205	SS72	\$8,748.00	\$8,864.00	\$8,980.00	\$9,127.00
72" Side Discharge (3/4" cleated belt)	72"	1-7/8 cu yd	1205	SSC72	\$9,260.00	\$9,376.00	\$9,492.00	\$9,639.00
84" Side Discharge (chevron belt)	84"	2-1/8 cu yd	1300	SS84	\$9,346.00	\$9,462.00	\$9,578.00	\$9,725.00
84" Side Discharge (3/4" cleated belt)	84"	2-1/8 cu yd	1300	SSC84	\$9,852.00	\$9,968.00	\$10,084.00	\$10,231.00
96" Side Discharge (chevron belt)	96"	2-1/2 cu yd	1560	SS96	\$11,536.00	\$11,652.00	\$11,768.00	\$11,915.00
96" Side Discharge (3/4" cleated belt)	96"	2-1/2 cu yd	1560	SSC96	\$12,036.00	\$12,152.00	\$12,268.00	\$12,415.00
Optional Agitator Speed Control Valve - Factory Installed Only				LP102468	\$1,904.00			
Optional 90" Hose Kit c/w Flat Faced Couplers				HK90	\$324.00			
Optional 90" Hose Kit c/w 90° Flat Faced Couplers				HK9090	\$324.00			
Optional Spring Hose Mount Kit				SHMK	\$147.00			
CAT 2 Three Point Hitch Mount c/w Tilting Cylinder				Price Code A +	\$1,361.00			

Side Discharge Buckets



SSB72

- **Minimum 12 GPM required**
- Made of same material as sawdust bucket
- Baffle brace and beater to improve flow and keep weight off belt
- 34"H x 50"L outside dimensions
- Two hydraulic motors on discharge belt (72", 84" & 96" only)
- Bolted adaptation for loader quick-tach. Easily convert to most loaders

For Outside Width add 2-1/2" to Inside Width dimension.

Side Discharge Sand Bucket	Inside Width	Heaped Capacity	Weight	Part #	Price Code			
					A	B	C	D
		Approx	in lbs					
60" Side Discharge - Sand	60"	2/3 cu yd	1000	SSB60	\$8,223.00	\$8,339.00	\$8,455.00	\$8,602.00
72" Side Discharge - Sand	72"	1 cu yd	1085	SSB72	\$8,748.00	\$8,864.00	\$8,980.00	\$9,127.00
84" Side Discharge - Sand	84"	1-1/3 cu yd	1175	SSB84	\$9,346.00	\$9,462.00	\$9,578.00	\$9,725.00
96" Side Discharge - Sand	96"	1-2/3 cu yd	1510	SSB96	\$11,536.00	\$11,652.00	\$11,768.00	\$11,915.00
Optional Agitator Speed Control Valve - Factory Installed Only				LP102468	\$1,904.00			
Optional 90" Hose Kit c/w Flat Faced Couplers				HK90	\$324.00			
Optional 90" Hose Kit c/w 90° Flat Faced Couplers				HK9090	\$324.00			
Optional Spring Hose Mount Kit				SHMK	\$147.00			
CAT 2 Three Point Hitch Mount c/w Tilting Cylinder				Price Code A +	\$1,361.00			

Rubber Scrapers



RFH60

- Power angle
- Easy on concrete or tiled floor mangers
- 24" high
- Angles 45° either direction

Rubber Feed Alley Scraper	Weight	Part #	Price Code			
			A	B	C	D
	in lbs					
60" Wide Rubber Feed Alley Scraper	495	RFH60	\$3,459.00	\$3,575.00	\$3,691.00	\$3,838.00
72" Wide Rubber Feed Alley Scraper	525	RFH72	\$3,508.00	\$3,624.00	\$3,740.00	\$3,887.00
84" Wide Rubber Feed Alley Scraper	555	RFH84	\$3,557.00	\$3,673.00	\$3,789.00	\$3,936.00
Optional 90" Hose Kit c/w Flat Faced Couplers		HK90	\$324.00			
Optional Spring Hose Mount Kit		SHMK	\$147.00			



RSH60

- Heavy duty rubber for longer life
- Deeper scraper for more volume and smoother operation
- Enclosed frame with splash plate
- 18" high rubber

Heavy Duty Rubber Free Stall Scraper	Weight	Part #	Price Code			
			A	B	C	D
	in lbs					
60" Rubber Free Stall Scraper HD Standard	340	RSH60	\$2,172.00	\$2,288.00	\$2,404.00	\$2,551.00
72" Rubber Free Stall Scraper HD Standard	355	RSH72	\$2,343.00	\$2,459.00	\$2,575.00	\$2,722.00
84" Rubber Free Stall Scraper HD Standard	380	RSH84	\$2,501.00	\$2,617.00	\$2,733.00	\$2,880.00
96" Rubber Free Stall Scraper HD Standard	410	RSH96	\$2,758.00	\$2,874.00	\$2,990.00	\$3,137.00

Rubber Scrapers



RSBDH60

- Heavy duty rubber for longer life
- Deeper scraper for more volume and smoother operation
- Enclosed frame with splash plate
- Allows clean-out of corners
- 18" high rubber

Heavy Duty Rubber Free Stall Scraper	Weight	Part #	Price Code			
Back Drag	in lbs		A	B	C	D
60" Rubber Free Stall Scraper HD Back Drag	475	RSBDH60	\$2,758.00	\$2,874.00	\$2,990.00	\$3,137.00
72" Rubber Free Stall Scraper HD Back Drag	505	RSBDH72	\$2,971.00	\$3,087.00	\$3,203.00	\$3,350.00
84" Rubber Free Stall Scraper HD Back Drag	545	RSBDH84	\$3,166.00	\$3,282.00	\$3,398.00	\$3,545.00
96" Rubber Free Stall Scraper HD Back Drag	600	RSBDH96	\$3,471.00	\$3,587.00	\$3,703.00	\$3,850.00



RSHY815

- Heavy duty rubber for longer life
- Hydraulic flow divider for equal movement of wings
- 24" tall rubber

Hydraulic Adjustable Rubber Scraper	Width		Weight	Part #	Price Code			
	Closed	Open	in lbs		A	B	C	D
Hydraulic Adjustable Rubber Scraper	8'	15'	1285	RSHY815	\$9,266.00	\$9,382.00	\$9,498.00	\$9,645.00
Hydraulic Adjustable Rubber Scraper	9'	16'	1390	RSHY916	\$9,547.00	\$9,663.00	\$9,779.00	\$9,926.00
Optional 90" Hose Kit c/w Flat Faced Couplers				HK90	\$324.00			
Optional Spring Hose Mount Kit				SHMK	\$147.00			

RUBBER SCRAPERS



- **Minimum 20 GPM required**
- Maximum flow 40 GPM
- Facing drum mounted on a 4 ft frame
- 400 Brinell high tensile steel teeth on drum
- Includes hose kit and flat-faced couplers
- Dual drive motors
- Heavy duty roller drive chains

SBFD72

Silage Facer - Frame Mount	Weight	Part #	Price Code			
	in lbs		A	B	C	D
72" Silage Bunk Facer w/ 4 Ft Frame	1010	SBFD72	\$8,235.00	\$8,351.00	\$8,467.00	\$8,614.00
72" Silage Bunk Facer w/ 6 Ft Frame	1075	SBFD726	\$8,547.00	\$8,663.00	\$8,779.00	\$8,926.00
72" Silage Bunk Facer w/ 8 Ft Frame	1180	SBFD728	\$8,864.00	\$8,980.00	\$9,096.00	\$9,243.00
72" Silage Bunk Facer w/ 10 Ft Frame	1240	SBFD7210	\$9,175.00	\$9,291.00	\$9,407.00	\$9,554.00
84" Silage Bunk Facer w/ 4 Ft Frame	1085	SBFD84	\$8,632.00	\$8,748.00	\$8,864.00	\$9,011.00
84" Silage Bunk Facer w/ 6 Ft Frame	1150	SBFD846	\$8,943.00	\$9,059.00	\$9,175.00	\$9,322.00
84" Silage Bunk Facer w/ 8 Ft Frame	1255	SBFD848	\$9,254.00	\$9,370.00	\$9,486.00	\$9,633.00
84" Silage Bunk Facer w/ 10 Ft Frame	1315	SBFD8410	\$9,565.00	\$9,681.00	\$9,797.00	\$9,944.00
96" Silage Bunk Facer w/ 4 Ft Frame	1150	SBFD96	\$9,041.00	\$9,157.00	\$9,273.00	\$9,420.00
96" Silage Bunk Facer w/ 6 Ft Frame	1215	SBFD966	\$9,352.00	\$9,468.00	\$9,584.00	\$9,731.00
96" Silage Bunk Facer w/ 8 Ft Frame	1320	SBFD968	\$9,669.00	\$9,785.00	\$9,901.00	\$10,048.00
96" Silage Bunk Facer w/ 10 Ft Frame	1380	SBFD9610	\$9,980.00	\$10,096.00	\$10,212.00	\$10,359.00
Optional Spring Hose Mount Kit		SHMK	\$147.00			



- **Minimum 20 GPM required**
- Maximum flow 40 GPM
- Facing drum mounted on bucket
- 400 Brinell high tensile steel teeth on drum
- Dual drive motors
- Heavy duty roller drive chains
- Includes hose kit and flat-faced couplers

MBHVSBF72

For Outside Width add 2" to Inside Width column.

Silage Facer - Bucket Mount	Inside Width	Struck Cap - Level	Heaped Cap - Approx	Weight	Part #	Price Code			
		cu ft	cu ft			A	B	C	D
72" Silage Facer/Bucket Mounted	72"	28.5	35.6	1160	MBHVSBF72	\$10,889.00	\$11,005.00	\$11,121.00	\$11,268.00
84" Silage Facer/Bucket Mounted	84"	33.3	41.6	1275	MBHVSBF84	\$11,420.00	\$11,536.00	\$11,652.00	\$11,799.00
96" Silage Facer/Bucket Mounted	96"	38.1	47.5	1385	MBHVSBF96	\$12,164.00	\$12,280.00	\$12,396.00	\$12,543.00
96" Silage Facer Mounted On Telehandler Bucket	96"	54.0	59.4	1780	THMBSBF96	\$14,354.00	\$14,470.00	\$14,586.00	\$14,733.00
Optional Spring Hose Mount Kit					SHMK	\$147.00			

Silage Attachments



BK60

- Slice bales up to 72" in diameter
- Grabs and retains plastic wrap and net wrap
- Top clamp eliminates "tail" dropping into mixer
- Cuts down TMR processing time up to 30%
- The BK60 and 72 have adjustable bumper to accommodate bales down to 48"
- Individual bolt on knives for easy replacement
- Minimum hydraulic pressure: 2700 PSI

Bale Knife	Bale Diameter	Bale Width	Weight	Part #	Price Code				Less Frame
					A	B	C	D	
Loader Mount			in lbs						
Bale Knife Bolt on Kit			145	BOKBK	\$562.00	\$678.00	\$794.00	\$941.00	
48" Bale Knife (LESS FRAME)	48"	60"	1460	BK48LF					\$10,126.00
60" Bale Knife (LESS FRAME)	48" - 60"	60"	1570	BK60LF					\$10,419.00
72" Bale Knife (LESS FRAME)	48" - 72"	72"	2025	BK72LF					\$11,054.00
Install Bolt on Kit on Bale Knife					\$92.00				
Optional 90" Hose Kit c/w Flat Faced Couplers				HK90	\$324.00				
Optional 90" Hose Kit c/w 90° Flat Faced Couplers				HK9090	\$324.00				
Optional Spring Hose Mount Kit				SHMK	\$147.00				

For complete price add BOKBK price to BK of choice



MBHVSG72

- Heavy duty grapple integrated into the bucket design
- Strategic pivoting arc design on the grapple for more power and less disturbance of the bunk silo face
- 3 x 16 cylinders with 1½" diameter pins
- 2" diameter pivot pins on grapple
- ¾" AR400 bolt on grapple teeth

For Outside Width add 2" to Inside Width column.

Silage Grapple Bucket	Inside Width	Struck Cap - Level	Heaped Cap - Approx	Weight	Part #	Price Code			
						A	B	C	D
		cu ft	cu ft	in lbs					
72" Silage Grapple Bucket	72"	27.3	39.5	1555	MBHVSG72	\$8,601.00	\$8,717.00	\$8,833.00	\$8,980.00
84" Silage Grapple Bucket	84"	31.8	46.2	1730	MBHVSG84	\$9,199.00	\$9,315.00	\$9,431.00	\$9,578.00
96" Silage Grapple Bucket	96"	36.3	52.9	1915	MBHVSG96	\$10,236.00	\$10,352.00	\$10,468.00	\$10,615.00
96" Telehandler Silage Grapple Bucket	96"	59.4	93.0	2260	THMBHVSG96	\$11,456.00	\$11,572.00	\$11,688.00	\$11,835.00
108" Silage Grapple Bucket	108"	40.9	59.7	2195	MBHVSG108	\$12,292.00	\$12,408.00	\$12,524.00	\$12,671.00
108" Telehandler Silage Grapple Bucket	108"	68.1	104.6	2435	THMBHVSG108	\$12,987.00	\$13,103.00	\$13,219.00	\$13,366.00
Optional Bolt On Guard for MBHVSG72				27	SG72SG	\$610.00			
Optional Bolt On Guard for MBHVSG84				32	SG84SG	\$635.00			
Optional Bolt On Guard for MBHVSG96				37	SG96SG	\$659.00			
Optional Bolt On Guard for MBHVSG108				42	SG108SG	\$714.00			
Optional 90" Hose Kit c/w Flat Faced Couplers					HK90	\$324.00			
Optional 90" Hose Kit c/w 90° Flat Faced Couplers					HK9090	\$324.00			
Optional Spring Hose Mount Kit					SHMK	\$147.00			

SILAGE ATTACHMENTS

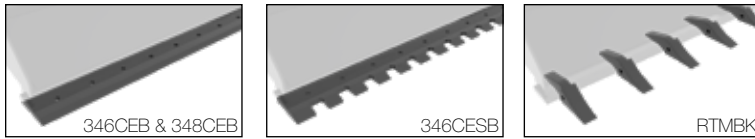

Bucket Accessories

	UOM	Part #	Price
3/4 X 6 Double Bevel Bolt On Cutting Edge c/w Bolts & Nuts	ft	346CEB	\$86.00
3/4 X 8 Double Bevel Bolt On Cutting Edge c/w Bolts & Nuts	ft	348CEB	\$113.00
3/4 X 6 Single Bevel Serrated Bolt On Cutting Edge c/w Bolts & Nuts	ft	346CESB	\$107.00
Knock On Ripper Teeth c/w Weld On Adapter & Flex Pin	ea	RTMBK	\$86.00



FB10

- For front wheel assist tractors only
- Compatible with SB5QDM Series undercarriage blade mounts. See Undercarriage Tractor Mounts on page 60
- Heavy duty construction with two angle cylinders
- Reversible cutting edge
- Skid shoes are standard
- 58" high blade
 - (34" high mouldboard)
 - (24" high mesh guard)
- 3 x 16 cylinders with 1½" diameter pins
- Available in CAT 2 or 3, three point hitch

5000 Series Silage Blade - Front Wheel Assist Tractors	Weight	Part #	Price Code				3PH Mount
			A	B	C	D	
110 - 300 HP Tractors	in lbs						
10' Front Silage Blade	2170	FB10	\$12,237.00	\$12,353.00	\$12,469.00	\$12,616.00	\$12,921.00
12' Front Silage Blade	2535	FB12	\$12,695.00	\$12,811.00	\$12,927.00	\$13,074.00	\$13,379.00
14' Front Silage Blade	2765	FB14	\$13,237.00	\$13,353.00	\$13,469.00	\$13,616.00	\$13,921.00
Optional hydraulic power tilt	165	FBHPT	\$2,721.00				
Optional 90" Hose Kit c/w Flat Faced Couplers		HK90	\$324.00				

Electical Wiring Kit (7, 8 or 14 Pin) - For OEM Connection

Optional OEM Connection Wire Kit	UOM	Part #	Price
ASV 8 Pin Wiring Kit (Single Deutsch Plug)	ea	EWKSD8CAT	\$458.00
Bobcat 14 Pin Wiring Kit (Single Deutsch Plug)	ea	EWKSD14BO	\$458.00
Bobcat 7 Pin Wiring Kit (Single Deutsch Plug)	ea	EWKSD7BO	\$1,410.00
Case 14 Pin Wiring Kit (Single Deutsch Plug)	ea	EWKSD14CNH	\$458.00
Caterpillar 14 Pin Wiring Kit (Single Deutsch Plug)	ea	EWKSD14CAT	\$458.00
Caterpillar 8 Pin Wiring Kit (Single Deutsch Plug)	ea	EWKSD8CAT	\$458.00
Gehl 14 Pin Wiring Kit (Single Deutsch Plug)	ea	EWKSD14CAT	\$458.00
JCB 14 Pin Wiring Kit (Single Deutsch Plug)	ea	EWKSD14KU	\$458.00
John Deere 244J Loaders 14 Pin Wiring Kit (Single Deutsch Plug)	ea	EWKSD14JD	\$458.00
John Deere 14 Pin Wiring Kit (Single Deutsch Plug)	ea	EWKSD14JD	\$458.00
Kubota 14 Pin Wiring Kit (Single Deutsch Plug)	ea	EWKSD14KU	\$458.00
Merlo 10 Pin Wiring Kit (Single Deutsch Plug)	ea	EWKSD10ME	\$458.00
New Holland 14 Pin Wiring Kit (Single Deutsch Plug)	ea	EWKSD14CNH	\$458.00
Takeuchi 14 Pin Wiring Kit (Single Deutsch Plug)	ea	EWKSD14TA	\$458.00
Volvo 14 Pin Wiring Kit (Single Deutsch Plug)	ea	EWKSD14KU	\$458.00
Wacker Neuson 14 Pin Wiring Kit (Single Deutsch Plug)	ea	EWKSD14KU	\$458.00

Call for makes or models not listed.

HLA **SILAGE** ATTACHMENTS **BLADE**



6000 Series Silage Blade Articulated Tractors

The HLA 6000 Series Silage Blade is specifically designed for articulated tractors. This rugged angle blade is particularly suited for moving high volumes of silage when the big harvest comes in. Equipped with hydraulic angle and tilt, this blade evenly cuts across silage bunkers directing materials to create a level area for packing. The Silage Blade is a two piece quick attach style unit consisting of the DMA Undermount custom fitted to each tractor and a rugged DBA silage blade and frame available in a variety of widths.

1 DMA Undermount

- Tucks in close to the frame for permanent mounting
- Forward mounted hydraulic connectors for ease of connection
- No tool quick attach locking pins secure the blade frame to the undermount

2 DBA Silage Blade & Frame

- Dual manual jacks ensures easy hook up and safe storage
- Hydraulic radial lift
- Hydraulic tilt
- Hydraulic angle
- 63" high blade (42" high mouldboard)
(21" high mesh guard)

Silage Blade - Articulated Tractors

6000 Series DMA Undermounts		
Model #	Part #	Price
Challenger MT845C	DMA6050CHMT845C	\$12,347.00
Challenger MT955E	DMA6050CHMT955E	\$12,347.00
Case IH STX275	DMA6000CISTX275	\$12,347.00
Case IH Stieger 335	DMA6000CIST335	\$12,347.00
Case IH Stieger 350	DMA6000CIST400	\$12,347.00
Case IH Stieger 400	DMA6000CIST400	\$12,347.00
Case IH Stieger 435	DMA6000CISTX425	\$12,347.00
Case IH Stieger 450	DMA6000CIST400	\$12,347.00
Case IH STX380 Quad Trac	DMA6000CISTX425	\$12,347.00
Case IH STX425	DMA6000CISTX425	\$12,347.00
Case IH Stieger 450 Quad Trac	DMA6035CIST450T	\$12,347.00
Case IH Stieger 540 Quad Trac	DMA6035CIST450T	\$12,347.00
Case IH Stieger 580 Quad Trac	DMA6035CIST450T	\$12,347.00
Case IH Stieger 600	DMA6050CIST600	\$12,347.00
John Deere 8450	DMA6000JD8450	\$12,347.00
John Deere 8560	DMA6000JD8770	\$12,347.00
John Deere 8630	DMA6000JD8450	\$12,347.00
John Deere 8770	DMA6000JD8770	\$12,347.00
John Deere 9120*	DMA6000JD9320	\$12,347.00
John Deere 9220*	DMA6000JD9320	\$12,347.00
John Deere 9230	DMA6000JD9230	\$12,347.00
John Deere 9300*	DMA6000JD9320	\$12,347.00
John Deere 9330	DMA6000JD9230	\$12,347.00
John Deere 9320*	DMA6000JD9320	\$12,347.00
John Deere 9420*	DMA6000JD9320	\$12,347.00
John Deere 9520*	DMA6000JD9320	\$12,347.00
John Deere 9620*	DMA6000JD9320	\$12,347.00
John Deere 9360R	DMA6000JD9460R	\$12,347.00
John Deere 9370R**	DMA6035JD9470R	\$12,347.00
John Deere 9410R	DMA6000JD9460R	\$12,347.00
John Deere 9420R**	DMA6035JD9470R	\$12,347.00
John Deere 9420RX	DMA6035JD9470RX	\$13,677.00
John Deere 9460R	DMA6000JD9460R	\$12,347.00
John Deere 9470R Single Reduction Axle**	DMA6035JD9470R	\$12,347.00
John Deere 9470R Double Reduction Axle***	DMA6035JD9520R	\$12,347.00

John Deere 9470RX	DMA6035JD9470RX	\$13,677.00
John Deere 9470RT	DMA6000JD9470RT	\$12,347.00
John Deere 9510R	DMA6000JD9460R	\$12,347.00
John Deere 9520R***	DMA6035JD9520R	\$12,347.00
John Deere 9520RX	DMA6035JD9470RX	\$13,677.00
John Deere 9560R	DMA6000JD9460R	\$12,347.00
John Deere 9570R***	DMA6035JD9520R	\$12,347.00
John Deere 9570RX	DMA6035JD9470RX	\$13,677.00
John Deere 9620R***	DMA6035JD9520R	\$12,347.00
John Deere 9620RX	DMA6035JD9470RX	\$13,677.00
New Holland T9.390	DMA6000CIST400	\$12,347.00
New Holland T9.450	DMA6000CIST400	\$12,347.00
New Holland T9.505	DMA6000CIST400	\$12,347.00
Versatile 435	DMA6050VT435	\$12,347.00
Versatile 450DT	DMA6050VT450DT	\$12,347.00
Versatile 570 wheeled	DMA6050VT450DT	\$12,347.00
Versatile 9480	DMA6000VT9480	\$12,347.00

6000 Series DBA Silage Blade & Frame	Approx. Weight	Part #	Price
	in lbs		
14' Silage blade (Blade only)	5315	DBA600014	\$32,513.00
14' Silage blade (Blade only)	5220	DBA603514	\$32,513.00
14' Silage blade (Blade only)	5425	DBA605014	\$32,513.00
16' Silage blade (Blade only)	5660	DBA600016	\$36,131.00
16' Silage blade (Blade only)	5565	DBA603516	\$36,131.00
16' Silage blade (Blade only)	5770	DBA605016	\$36,131.00
18' Silage blade (Blade only)	6000	DBA600018	\$40,114.00
18' Silage blade (Blade only)	5905	DBA603518	\$40,114.00
18' Silage blade (Blade only)	6110	DBA605018	\$40,114.00

	Part #	Price
Add factory install	DMA6000IN	\$3,459.00

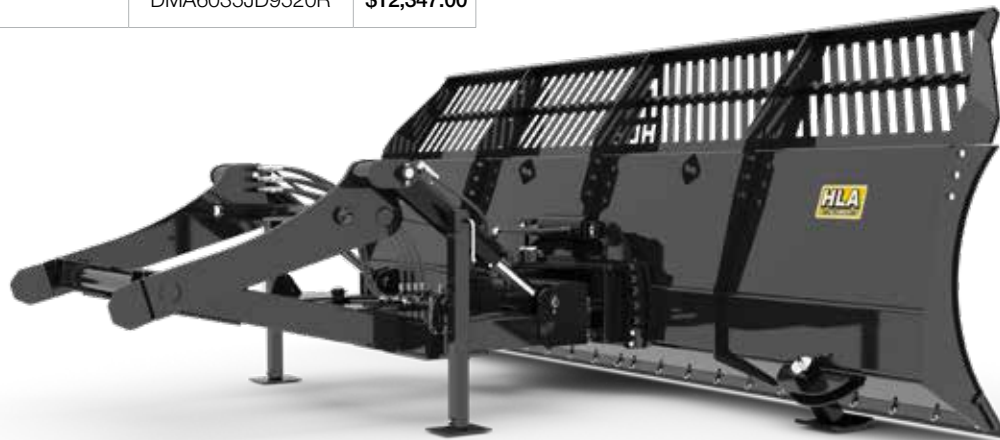

For tractors without OEM front axle supports, order the kit below	Approx. Weight in lbs	Part #	Price
*DMA6000JD9320 Front axle support kit	450	LP102951	\$3,014.00
**DMA6035JD9470R Front axle support kit - single reduction axle	450	LP103008	\$3,014.00
***DMA6035JD9520R Front axle support kit - double reduction axle	450	LP103009	\$3,014.00

SB5QDM Quick Attach Snow Blade Mount

The HLA Quick Attach Snow Blade Mount is securely connected to both the front and rear of your tractor. Relying on the rear of the mount, the force is pushed through the drawbar from the front of the mount providing incredible pushing strength. With parallel linkage, you can rest assured that the blade will always remain parallel to the ground whether it's raised for stacking snow or at full angle.

The quick release design relies on front and rear adapter brackets fitted to the tractor chassis. With the hydraulics connected, down pressure on the blade allows you to raise the undermount aligning it with the front bracket. Once engaged reversing the pressure raises the rear of the undermount locking it into the rear bracket.

Available for most makes, the undercarriage mount includes all hardware, hose kits and electro - hydraulic wire kit allowing for easy installation.

SB5QDM Quick Attach Snow Blade Mount	Weight	UOM	Part #	Price
SB5QDM Quick Attach Snow Blade Mount less Mount Kit	1500 lbs	ea	SB5QDMQF	\$8,656.00
SB5QDM Quick Attach Undermount Mount Kit	Variable	ea	see tractor listing	\$3,294.00
Optional Hydraulic Top Link Kit for SB5QDMQF	55 lbs	ea	SB5QDMHTLK	\$2,081.00
Optional Factory Blade Installation - SB5QDM		ea	SB5000IN	\$1,647.00

To Order And Price Blades Fitting To SB5QDM Quick Attach Snow Blade Mount

Choose desired blade part # and add mounting part #JRB416, which is Price Code D + \$549.00
Specify if connecting to midmount valve or rear remotes.



1 Power and Control

- Heavy duty parallel linkage for optimum lifting height
- JRB416 industrial mount for attachments is standard
- Package includes all mounting hardware and hose kits
- Mount Kits available for most tractor makes, call dealer for details
- Soft ride accumulator standard

2 Parallel Vertical Lift

- Blade remains parallel to ground even at full angle and raised
- Extra height for piling snow

3 Quick Release System

- Quick Release system allows for removal of the complete under mount in minutes

SB5QDM QUICK ATTACH SNOW BLADE MOUNT

SB5QDM Quick Attach Snow Blade Mount Kits

SB5QDM Quick Attach Snow Blade Mount Kits

Model #	Part #
Case IH	
Case IH Magnum 230 With Cat 3 Drawbar	SB5QDMBCIMA260C3
Case IH Magnum 230 With Cat 4 Drawbar	SB5QDMBCIMA260C4
Case IH Magnum 260 With Cat 3 Drawbar	SB5QDMBCIMA260C3
Case IH Magnum 260 With Cat 4 Drawbar	SB5QDMBCIMA260C4
Case IH Magnum 290 With Cat 3 Drawbar	SB5QDMBCIMA260C3
Case IH Magnum 290 With Cat 4 Drawbar	SB5QDMBCIMA260C4
Case IH Magnum 315 With Cat 3 Drawbar	SB5QDMBCIMA260C3
Case IH Magnum 315 With Cat 4 Drawbar	SB5QDMBCIMA260C4
Case IH Magnum 340 With Cat 3 Drawbar	SB5QDMBCIMA260C3
Case IH Magnum 340 With Cat 4 Drawbar	SB5QDMBCIMA260C4

John Deere

John Deere 7630	SB5QDMBJD7920
John Deere 7720	SB5QDMBJD7920
John Deere 7820	SB5QDMBJD7920
John Deere 7830	SB5QDMBJD7920
John Deere 7920	SB5QDMBJD7920
John Deere 7930	SB5QDMBJD7920
John Deere 8000 Series	SB5QDMBJD8000
John Deere 8010 Series	SB5QDMBJD8000
John Deere 8020 Series	SB5QDMBJD8000
John Deere 8030 Series	SB5QDMBJD8030
John Deere 8225R	SB5QDMBJD8030
John Deere 8235R	SB5QDMBJD8030
John Deere 8245R Tier 3	SB5QDMBJD8030
John Deere 8245R Tier 4B	SB5QDMBJD8030
John Deere 8260R	SB5QDMBJD8030
John Deere 8270R Tier 3	SB5QDMBJD8030
John Deere 8270R Tier 4B	SB5QDMBJD8030
John Deere 8285R	SB5QDMBJD8030
John Deere 8295R Tier 3	SB5QDMBJD8030
John Deere 8295R Tier 4B	SB5QDMBJD8030
John Deere 8310R	SB5QDMBJD8030
John Deere 8320R Tier 3	SB5QDMBJD8030
John Deere 8320R Tier 4B	SB5QDMBJD8030
John Deere 8335R	SB5QDMBJD8030
John Deere 8345R Tier 3	SB5QDMBJD8030

John Deere 8345R Tier 4B	SB5QDMBJD8030
John Deere 8360R	SB5QDMBJD8030
John Deere 8370R	SB5QDMBJD8030

Fendt

Fendt 822 S4	SB5QDMBFT824S4
Fendt 822 NA S4	SB5QDMBFT824S4
Fendt 824 S4	SB5QDMBFT824S4
Fendt 824 NA S4	SB5QDMBFT824S4
Fendt 826 S4	SB5QDMBFT824S4
Fendt 826 NA S4	SB5QDMBFT824S4
Fendt 828 S4	SB5QDMBFT824S4
Fendt 828 NA S4	SB5QDMBFT824S4

Kubota

Kubota M7-152	SB5QDMBKUM7171
Kubota M7-171	SB5QDMBKUM7171
Kubota M7-172	SB5QDMBKUM7171
Kubota M8-181	SB5QDMBKUM8201
Kubota M8-201	SB5QDMBKUM8201

New Holland

New Holland T8.275 With Cat 3 Drawbar	SB5QDMBNHT8390C3
New Holland T8.275 With Cat 4 Drawbar	SB5QDMBNHT8390C4
New Holland T8.300 With Cat 3 Drawbar	SB5QDMBNHT8390C3
New Holland T8.300 With Cat 4 Drawbar	SB5QDMBNHT8390C4
New Holland T8.330 With Cat 3 Drawbar	SB5QDMBNHT8390C3
New Holland T8.330 With Cat 4 Drawbar	SB5QDMBNHT8390C4
New Holland T8.360 With Cat 3 Drawbar	SB5QDMBNHT8390C3
New Holland T8.360 With Cat 4 Drawbar	SB5QDMBNHT8390C4
New Holland T8.390 With Cat 3 Drawbar	SB5QDMBNHT8390C3
New Holland T8.390 With Cat 4 Drawbar	SB5QDMBNHT8390C4

Versatile

Versatile Nemesis 175	SB5QDMBKUM8201
Versatile Nemesis 195	SB5QDMBKUM8201
Versatile Nemesis 210	SB5QDMBKUM8201

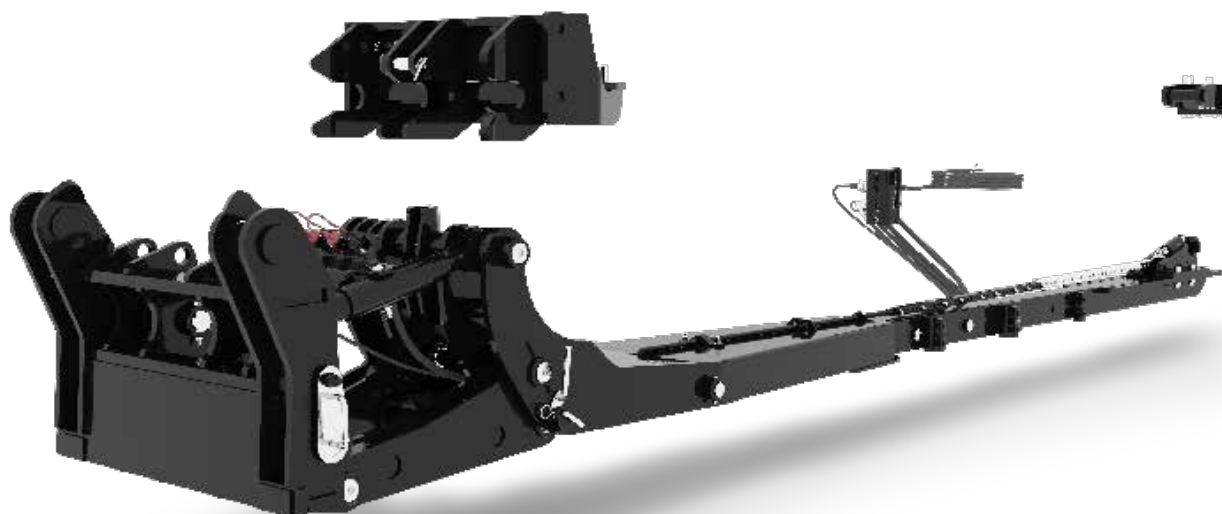

Loader Order Mounting Codes

Aeroquip	Part #	Price Code
Direct	AERO	B

Agco	Part #	Price Code
Quick Attach Mounts		
FL200A Hook Style Qtach	FNAO600	A
FL200A Skidsteer Style Qtach	BO500	A
FL200 Hook Style Qtach	FNAO600	A
FL600 Qtach	MF1090	B
676 Qtach	AG676	B
884 Pin Style Qtach	AG680	B

Direct To Loader Boom Mounts		
FL200 Direct	MF1040	B
FL200A Direct	MFDL260	B
FL400 Direct	MFDL280	B
FL400A Direct	MFDL280	B
FL500 Direct	MFDL280	B
SL44 Direct	MF1464	B
SL46 Direct	MF1466	B
SL46A Direct	AGSL46A	B
SL48 Direct	MF1040	B
SL48A Direct	MFDL260	B
680 Direct	AG680	B

Allied - FarmKing	Part #	Price Code
Quick Attach Mounts		
95 Qtach	AL195	B
195 Qtach	AL195	B
295 Qtach	AL295	B
390 Qtach	AL394	B
394 Qtach	AL394	B
395 Qtach	AL395Q	B
495 Qtach	AL595Q	B
590 Qtach	AL594	B
594 Qtach	AL594	B
595 Qtach	AL595Q	B
694 Qtach	AL694Q	B
695 Qtach	AL595Q	B
795 Qtach	AL795Q	B
894 Qtach	AL894	C
895 Qtach	AL895	C
2495 Qtach	AL2595	A
2495E Euro Qtach	AO600	A
2595 Qtach	AL2595	A
2595E Euro Qtach	AO600	A
2596 Qtach	AL2595	A
2596E Euro Qtach	AO600	A
2795 Qtach	AL2595	A
2795E Euro Qtach	AO600	A
2895 Qtach	AL2595	A

Direct To Loader Boom Mounts		
95 Direct	AL195	B
180 Direct	AL180	B
195 Direct	AL195	B
295 Direct	AL295	B
300 Direct	AL300	B
350 Direct	AL350	B
380 Direct	AL394	B
390 Direct	AL394	B
394 Direct	AL394	B

395 Direct	AL395	B
450 Direct	AL450	B
495 Direct	AL595	B
500 Direct	AL500	B
580 Direct	AL594	B
584 Direct	AL594	B
590 Direct	AL594	B
594 Direct	AL594	B
595 Direct	AL595	B
600 Direct	AL600	B
660 Direct	AL600	B
694 Direct	AL694	B
695 Direct	AL595	B
760 Direct	AL760	B
790 Direct	AL794	B
794 Direct	AL794	B
795 Direct	AL795	B
895 Direct	AL895D	B
2595 Direct	AL2595D	B
2596 Direct	AL2596D	B
2795E Direct	AL2795ED	B
2895 Direct	AL2895D	B

Allis Chalmers	Part #	Price Code
400 Direct	AC400	B
417 Direct	AC400	B
460 Direct	AC460	B
500 Direct	AC500	B
517 Direct	AC517	B
519 Direct	AC519	B

Alo	Part #	Price Code
Quick Attach Mounts		
160c Euro Qtach	AO600	A
160c Skidsteer Style Qtach	BO500	A
180c Euro Qtach	AO600	A
180 Skidsteer Style Qtach	BO500	A
300 Series Qtach (new style)	AO600	A
400 Series Qtach (new style)	AO600	A
500 Series Qtach (old style)	AO500	B
600 Series Qtach (new style)	AO600	A
700 Series Qtach (new style)	AO600	A
900 Series Qtach (new style)	AO600	A
Q20 Euro Qtach	AO600	A
Q20 Skidsteer Style Qtach	BO500	A
Q21 Euro Qtach	AO600	A
Q21 Skidsteer Style Qtach	BO500	A
Q25 Euro Qtach	AO600	A
Q25 Skidsteer Style Qtach	BO500	A
Q26 Euro Qtach	AO600	A
Q26 Skidsteer Style Qtach	BO500	A
Q30 Euro Qtach	AO600	A
Q30 Skidsteer Style Qtach	BO500	A
Q31 Euro Qtach	AO600	A
Q31 Skidsteer Style Qtach	BO500	A
Q33 Euro Qtach	AO600	A
Q33 Skidsteer Style Qtach	BO500	A
Q35 Euro Qtach	AO600	A
Q35 Skidsteer Style Qtach	BO500	A
Q36 Euro Qtach	AO600	A
Q36 Skidsteer Style Qtach	BO500	A
Q38 Euro Qtach	AO600	A

Loader Order Mounting Codes

Q38 Skidsteer Style Qtach	BO500	A
Q40 Euro Qtach	AO600	A
Q40 Skidsteer Style Qtach	BO500	A
Q41 Euro Qtach	AO600	A
Q41 Skidsteer Style Qtach	BO500	A
Q45 Euro Qtach	AO600	A
Q45 Skidsteer Style Qtach	BO500	A
Q46 Euro Qtach	AO600	A
Q46 Skidsteer Style Qtach	BO500	A
Q48 Euro Qtach	AO600	A
Q49 Euro Qtach	AO600	A
Q50 Euro Qtach	AO600	A
Q51 Euro Qtach	AO600	A
Q55 Euro Qtach	AO600	A
Q56 Euro Qtach	AO600	A
Q58 Euro Qtach	AO600	A
Q60 Euro Qtach	AO600	A
Q61 Euro Qtach	AO600	A
Q65 Euro Qtach	AO600	A
Q66 Euro Qtach	AO600	A
Q68 Euro Qtach	AO600	A
Q75 Euro Qtach	AO600	A
Q76 Euro Qtach	AO600	A
Q78 Euro Qtach	AO600	A
Q85 Euro Qtach	AO600	A
Q88 Euro Qtach	AO600	A
Q98 Euro/Alo HD Qtach	AOQ98	C
X1 Euro Qtach	AO600	A
X1 Skidsteer Qtach	BO500	A
X1S Euro Qtach	AO600	A
X1S Skidsteer Qtach	BO500	A
X2 Euro Qtach	AO600	A
X2 Skidsteer Qtach	BO500	A
X2S Euro Qtach	AO600	A
X2S Skidsteer Qtach	BO500	A
X3 Euro Qtach	AO600	A
X3 Skidsteer Qtach	BO500	A
X3S Euro Qtach	AO600	A
X3S Skidsteer Qtach	BO500	A
X4 Euro Qtach	AO600	A
X4 Skidsteer Qtach	BO500	A
X4S Euro Qtach	AO600	A
X4S Skidsteer Qtach	BO500	A
X5 Euro Qtach	AO600	A
X5 Skidsteer Qtach	BO500	A
X5S Euro Qtach	AO600	A
X5S Skidsteer Qtach	BO500	A
X16 Euro Qtach	AO600	A
X21 Euro Qtach	AO600	A
X21 Skidsteer Qtach	BO500	A
X26 Euro Qtach	AO600	A
X26 Skidsteer Qtach	BO500	A
X31 Euro Qtach	AO600	A
X31 Skidsteer Qtach	BO500	A
X36 Euro Qtach	AO600	A
X36 Skidsteer Qtach	BO500	A
X41 Euro Qtach	AO600	A
X41 Skidsteer Qtach	BO500	A
X46 Euro Qtach	AO600	A
X46 Skidsteer Qtach	BO500	A
X51 Euro Qtach	AO600	A
X51 Skidsteer Qtach	BO500	A

X56 Euro Qtach	AO600	A
X56 Skidsteer Qtach	BO500	A
Direct To Loader Boom Mounts		
100c Direct	AO100C	B
160c Direct	AO180C	B
180c Direct	AO180C	B
310 Direct	AO340	B
340 Direct	AO340	B
345 Direct	AO345	B
415 Direct	AO660	B
465UM Direct	AO675	B
465US Direct	AO675	B
510 Direct	AO660	B
520 Direct	AO660	B
525 Direct	AO660	B
540 Direct	AO660	B
545 Direct	AO660	B
620 Direct	AO660	B
640 Direct	AO660	B
660 Direct	AO660	B
670 Direct	AO660	B
675UM Direct	AO675	B
675US Direct	AO675	B
690UM Direct	AO690UM	B
690US Direct	AO690US	B
695UM Direct	AO675	B
695US Direct	AO675	B
710 Direct	AO660	B
720 Direct	AO660	B
730 DM Direct	AO660	B
740 Direct	AO660	B
750 Direct	AO660	B
755UM Direct	AO675	B
760 Direct	AO660	B
770UM Direct	AO675	B
770US Direct	AO675	B
790 Direct	AO790	B
910 Direct	AO660	B
920 Direct	AO660	B
930 Direct	AO660	B
940 Direct	AO660	B
960UM Direct	AO675	B
960US Direct	AO675	B
970UM Direct	AO675	B
970US Direct	AO675	B
980UM Direct	AO675	B
980US Direct	AO675	B
990 Direct	AO990	B
Q3 DM Direct	AOQ55DM	B
Q3L DM Direct	AOQ55DM	B
Q3M DM Direct	AOQ55DM	B
Q3S DM Direct	AOQ55DM	B
Q4 DM Direct	AOQ55DM	B
Q4L DM Direct	AOQ55DM	B
Q4M DM Direct	AOQ55DM	B
Q4S DM Direct	AOQ55DM	B
Q5 DM Direct	AOQ55DM	B
Q5L DM Direct	AOQ55DM	B
Q5M DM Direct	AOQ55DM	B
Q5S DM Direct	AOQ55DM	B
Q6 DM Direct	AOQ55DM	B
Q6L DM Direct	AOQ55DM	B

Loader Order Mounting Codes

Q6M DM Direct	AOQ55DM	B
Q6S DM Direct	AOQ55DM	B
Q7L DM Direct	AOQ55DM	B
Q7M DM Direct	AOQ55DM	B
Q7S DM Direct	AOQ55DM	B
Q20 DM Direct	AOQ55DM	B
Q20 DS Direct	AOQ40US	B
Q20 US Direct	AOQ40US	B
Q21 DM Direct	AOQ55DM	B
Q21 US Direct	AOQ40US	B
Q25 DM Direct	AOQ55DM	B
Q25 DS Direct	AOQ40US	B
Q25 US Direct	AOQ40US	B
Q26 DM Direct	AOQ55DM	B
Q26 US Direct	AOQ40US	B
Q30 DM Direct	AOQ55DM	B
Q30 DS Direct	AOQ40US	B
Q30 US Direct	AOQ40US	B
Q31 DM Direct	AOQ55DM	B
Q31 US Direct	AOQ40US	B
Q33 DM Direct	AOQ55DM	B
Q35 DM Direct	AOQ55DM	B
Q35 DS Direct	AOQ40US	B
Q35 US Direct	AOQ40US	B
Q36 DM Direct	AOQ55DM	B
Q36 US Direct	AOQ40US	B
Q38 DM Direct	AOQ55DM	B
Q40 DM Direct	AOQ55DM	B
Q40 US Direct	AOQ40US	B
Q41 DM Direct	AOQ55DM	B
Q41 US Direct	AOQ40US	B
Q45 DM Direct	AOQ55DM	B
Q45 US Direct	AOQ40US	B
Q46 DM Direct	AOQ55DM	B
Q46 US Direct	AOQ40US	B
Q48 DM Direct	AOQ55DM	B
Q49 DM Direct	AOQ55DM	B
Q50 DM Direct	AOQ55DM	B
Q50 US Direct	AOQ40US	B
Q51 DM Direct	AOQ55DM	B
Q51 US Direct	AOQ40US	B
Q55 DM Direct	AOQ55DM	B
Q55 UM Direct	AOQ55DM	B
Q55 US Direct	AOQ40US	B
Q56 DM Direct	AOQ55DM	B
Q56 UM Direct	AOQ55DM	B
Q56 US Direct	AOQ40US	B
Q58 DM Direct	AOQ55DM	B
Q60 DM Direct	AOQ55DM	B
Q61 DM Direct	AOQ55DM	B
Q65 DM Direct	AOQ55DM	B
Q65 UM Direct	AOQ55DM	B
Q66 DM Direct	AOQ55DM	B
Q66 UM Direct	AOQ55DM	B
Q68 DM Direct	AOQ55DM	B
Q75 DM Direct	AOQ55DM	B
Q75 UM Direct	AOQ55DM	B
Q76 DM Direct	AOQ55DM	B
Q76 UM Direct	AOQ55DM	B
Q78 DM Direct	AOQ55DM	B
Q85 DM Direct	AOQ85	B
Q88 DM Direct	AOQ85	B
Q98 DM Direct	AOQ98D	C

X1 Direct	AOX36	B
X1S Direct	AOX36	B
X2 Direct	AOX36	B
X2S Direct	AOX36	B
X3 Direct	AOX36	B
X3S Direct	AOX36	B
X4 Direct	AOX36	B
X4S Direct	AOX36	B
X5 Direct	AOX36	B
X5S Direct	AOX36	B
X16 Direct	AOX36	B
X21 Direct	AOX36	B
X26 Direct	AOX36	B
X31 Direct	AOX36	B
X36 Direct	AOX36	B
X41 Direct	AOX36	B
X46 Direct	AOX36	B
X51 Direct	AOX36	B
X56 Direct	AOX36	B
1080 Direct	AO675	B
1055 DM Direct	AO675	B

Avant	Part #	Price Code
419 Qtach	AVQ	A
420 Qtach	AVQ	A
520 Qtach	AVQ	A
528 Qtach	AVQ	A
630 Qtach	AVQ	A
635 Qtach	AVQ	A
745 Qtach	AVQ	A
750 Qtach	AVQ	A

Belarus	Part #	Price Code
PK4 Direct	BEPK4	B
B-500 Direct	BEB500	B
700 Direct	BE700	B
1310 Direct	BE1310	B

Bobcat	Part #	Price Code
Quick Attach Mounts		
6TL Skidsteer Qtach	BO500	A
7TL Skidsteer Qtach	BO500	A
8TL Skidsteer Qtach	BO500	A
9TL Skidsteer Qtach	BO500	A
FL6 Qtach	BO500	A
FL7 Qtach	BO500	A
FL8 Qtach	BO500	A
FL9 Qtach	BO500	A
FL9-5 Qtach	BO500	A
V417 Qtach	BO500	A
V518 Qtach	BO518	C
V623 Qtach	BO518	C
V638 Qtach	BO518	C
V723 Qtach	BO518	C
3650 UTV Qtach	BO3650Q	C

Direct To Loader Boom Mounts		
6TL Direct	BO6TL	B
7TL Direct	BO6TL	B
8TL Direct	BO8TL	B
FL8 Direct	BOFL8	B
V417 Direct	BOV417	D
V519 Direct	BOV519D	D+305

Loader Order Mounting Codes

Branson	Part #	Price Code
Quick Attach Mounts		
BL10 Qtach	BRBL10A	B
BL10A Qtach	BRBL10A	B
BL20A Qtach	BRBL10A	B
BL25R Skidsteer Style Qtach	BO500	A
BL50 Skidsteer Style Qtach	BO500	A
Direct To Loader Boom Mounts		
SL00 Direct	BRSL00	B
SL15 Direct	BRSL00	B
BL25R Direct	BRBL25R	B

Bush Hog	Part #	Price Code
Quick Attach Mounts		
M346 Qtach	BHM346Q	C
M446 Qtach	BHM346Q	C
M546 Qtach	BHM346Q	C
M646 Qtach	BHM346Q	C
2045 Skidsteer Style Qtach	BO500	A
2347 Skidsteer Style Qtach	BO500	A
2425 Qtach (pin style)	BH2400	B
2426 Qtach	BH2426Q	C
2427 Skidsteer Style Qtach	BO500	A
2446 Qtach	BH2426Q	C
2447 Skidsteer Style Qtach	BO500	A
2846 Qtach	BH2426Q	C
2847 Skidsteer Style Qtach	BO500	A
3045 Skidsteer Style Qtach	BO500	A
3225 Qtach (pin style)	BH3226	B
3226 Qtach	BH3226Q	C
3227 Skidsteer Style Qtach	BO500	A
3545 Skidsteer Style Qtach	BO500	A
4045 Skidsteer Style Qtach	BO500	A
5045 Skidsteer Style Qtach	BO500	A
6045 Skidsteer Style Qtach	BO500	A

Direct To Loader Boom Mounts		
1840 Direct	BH1847	B
1845 Direct	BH1847	B
1847 Direct	BH1847	B
2400 Direct	BH2400	B
2425 Direct	BH2400	B
2440 Direct	BH2400	B
2445 Direct	BH2400	B
2840 Direct	BH2400	B
2845 Direct	BH2400	B
2846 Direct	BH2846D	B
3045 Direct	FC4045	B
3225 Direct	BH3226	B
3226 Direct	BH3226	B
3400 Direct	BH2400	B
3545 Direct	FC4045	B
3450 Direct	BH3226	B
5045 Direct	FC4045	B
6045 Direct	FC4045	B

Case	Part #	Price Code
Quick Attach Mounts		
21D Qtach	NHLW50Q	D+549
21F Skidsteer Style Qtach	BO500	A
121F Hook Style Qtach	NHW80CQ	D+305

121F Skidsteer Style Qtach	BO500	A
221D Qtach	CA321DQ	D+549
221F Hook Style Qtach	NHW80CQ	D+305
221F Skidsteer Style Qtach	BO500	A
321D Qtach	CA321DQ	D+549
321F Hook Style Qtach	NHW80CQ	D+305
321F Skidsteer Style Qtach	BO500	A
521D JRB Qtach	JRB416	D+549
521E JRB Qtach	JRB416	D+549
621D JRB Qtach	JRB416	D+549
621E JRB Qtach	JRB416	D+549
TX742 Qtach	ST8042	D+305
TX842 Qtach	ST8042	D+305
TX945 Qtach	ST8042	D+305
FFC Qtach	CAFFC	D+305

Direct To Loader Boom Mounts		
21F Direct up to May 30/18	NHW80C	D+549
21F Direct May 30/18 to current	CA321F	D+549
W24 Direct	CAW24	D+305
54L Direct	CA54L	B
55 Direct	CA55	C
56L Direct	CA56	B
58L Direct	CA56	B
60 Direct	CA60	B
65 Direct	CA65	B
66L Direct	CA56	B
90 Direct	CA90	B
96L Direct	CA96L	B
121F Direct up to May 30/18	NHW80C	D+549
121F Direct May 30/18 to current	CA321F	D+549
221F Direct up to May 30/18	NHW80C	D+549
221F Direct May 30/18 to current	CA321F	D+549
321F Direct up to May 30/18	NHW80C	D+549
321F Direct May 30/18 to current	CA321F	D+549
480ELL Direct	CA480ELL	D
521D Direct	NHW110B	D+305
521D XT Direct	CA521EXT	D+305
521D ZBAR Direct	NHW110B	D+305
521E Direct	NHW110B	D+305
521E XT Direct	CA521EXT	D+305
521E ZBAR Direct	NHW110B	D+305
521F ZBAR Direct	NHW110B	D+305
570LXT Direct	CA580L	D
570L Direct	CA580L	D
570MXT Direct	CA580L	D
580B Direct	CA580B	D
580C Direct	CA580C	D
580D Direct	CA580C	D
580K Direct	CA580K	D
580L Direct	CA580L	D
580LXT Direct	CA580L	D
580M Direct	CA580L	D
580 Super E Direct	CA580E	D
580N Direct	CA580L	D
580SM Direct	CA580L	D
580SN Direct	CA580L	D
590L Direct	CA580L	D
590SL Direct	CA580L	D
590SM Direct	CA580L	D
621B ZBAR Direct	CA621B	D+305
621C ZBAR Direct	CA621B	D+305
621D ZBAR Direct	CA621EZ	D+305

Loader Order Mounting Codes

621D XT Direct	CA621EXT	D+305
621E ZBAR Direct	CA621EZ	D+305
621E XT Direct	CA621EXT	D+305
721D Direct	CA721D	D+549
721E Direct	CA721D	D+549
721F Direct	CA721D	D+549
721G Direct	CA721D	D+549
821C Direct	CA821C	D+549
821E Direct	CA821E	D+549
821G Direct	CA821E	D+549
921 Direct	CA921E	D+549
921B Direct	CA921E	D+549
921C Direct	CA921E	D+549
921E Direct	CA921E	D+549

Case IH	Part #	Price Code
Quick Attach Mounts		
LX114 Skidsteer Qtach	BO500	A
LX118 Skidsteer Qtach	BO500	A
LX132 Skidsteer Qtach	BO500	A
LX152 Skidsteer Qtach	BO500	A
LX156 Qtach	AO600	A
LX162 Qtach	AO600	A
LX172 Qtach	AO600	A
LX232 Skidsteer Qtach	BO500	A
LX252 Skidsteer Qtach	BO500	A
L300 Qtach	CI510Q	B
LX340 Skidsteer Qtach	BO500	A
L350 Skidsteer Qtach	BO500	A
LX350 Skidsteer Qtach	BO500	A
L360 Skidsteer Qtach	BO500	A
LX360 Skidsteer Qtach	BO500	A
L400 - L750 Qtach	AO600	A
510 Qtach	CI510Q	B
520 Qtach	CI510Q	B
L530 Skidsteer Style Qtach	BO500	A
L540 Skidsteer Style Qtach	BO500	A
L650 Qtach	AO600	A
LX700 Series Qtach	AO600	A
L700 Series Qtach	AO600	A
L795 Series Qtach	AOQ98	C
710 Qtach	CI710Q	C
720 Qtach	CI710Q	C
890 Qtach	CI710Q	C
2250 Qtach	IH2250	B
2255 Qtach	IH2250	B
Direct To Loader Boom Mounts		
L103 Direct	AOQ55DM	B
L104 Direct	AOQ55DM	B
L105 Direct	AOQ55DM	B
LX110 Direct	NH10LA	B
LX112 Direct	NH12LA	B
LX114 Direct	CILX114	B
LX116 Direct	NH17LA	B
LX118 Direct	NH17LA	B
L130 Direct	FO7308	B
LX132 Direct	CILX132	B
LX152 Direct	CILX132	B
L160 Direct	NH17LA	B
LX156 Direct	CILX162	B
LX162 Direct	CILX162	B

LX172 Direct	CILX162	B
LX232 Direct	CILX232	B
LX252 Direct	CILX232	B
L300 Direct	CI510	B
L340 Direct	NH240TL	B
LX340 Direct	NH240TL	B
L350 Direct	NH250TL	B
LX350 Direct	NH250TL	B
L360 Direct	NH250TL	B
L400 NSL Direct	CIL500	B
L405 NSL Direct	CIL500	B
L500 SL Direct	CIL500	B
L500 NSL Direct	CIL500	B
L505 Direct	CIL500	B
510 Direct	CI510	B
520 Direct	CI510	B
L530 Direct	CIL540	B
L540 Direct	CIL540	B
L550 NSL Direct	CIL500	B
L550 SL Direct	CIL500	B
555 Direct	CIL500	B
L565 Direct	AOX36	B
L575 Direct	AOX36	B
L600 Direct	CIL650	B
L610 Direct	CIL610	B
L620 Direct	CIL620	B
L630 Direct	CIL620	B
L650 Direct	CIL650	B
L720 Direct	AOQ55DM	B
LX720 Direct	AOQ55DM	B
L725 Direct	AOQ55DM	B
L730 Direct	AOQ55DM	B
L735 Direct	AOQ55DM	B
LX730 Direct	AOQ55DM	B
L740 Direct	AOQ55DM	B
LX740 Direct	AOQ55DM	B
L745 Direct	AOQ55DM	B
L750 Direct (Quicke)	AOQ55DM	B
LX750 Direct	AOQ55DM	B
L760 Direct	AOQ55DM	B
LX760 Direct	AOQ55DM	B
L770 Direct	AOQ55DM	B
L775 Direct	AOQ55DM	B
LX770 Direct	AOQ55DM	B
LX780 Direct	AOQ85	B
L790 Direct	AOQ98D	C
810LA Direct	AOQ55DM	B
815LA Direct	AOQ55DM	B
830LA Direct	AOQ55DM	B
857LA Direct	AOQ55DM	B
1501 Direct	IH1501	C
1550 Direct	IH1501	C
1850 Direct	IH2200	B
2000 Direct	IH2000	B
2200 Direct	IH2200	B
2250 Direct	IH2250	B
2255 Direct	IH2250	B
2350 Direct	IH2250	B
2355 Direct	CI2355	B
2500 Direct	IH2500	B
3200 Direct	IH3200	B

Caterpillar	Part #	Price Code
Quick Attach Mounts		
IT12 Qtach	CAIT24	D+305
IT14 Qtach	CAIT24	D+305
IT18 Qtach	CAIT24	D+305
IT24 Qtach	CAIT24	D+305
IT28 Qtach	CAIT24	D+305
IT38G Qtach	CAIT38G	D+549
TH220B Qtach	CAIT24	D+305
TH330B Qtach	CAIT24	D+305
TH350B Qtach	CAIT24	D+305
TH360B Qtach	CAIT24	D+305
TH407 Qtach	CAIT24	D+305
IT416 Qtach	CAIT24	D+305
IT420 Qtach	CAIT24	D+305
420F IT Qtach	CAIT24	D+305
IT424 Qtach	CAIT24	D+305
430F IT Qtach	CAIT24	D+305
TH460B Qtach	CAIT24	D+305
TH560B Qtach	CAIT24	D+305
TH580B Qtach	CAIT24	D+305
TL642 Qtach	CAIT24	D+305
901C2 Skidsteer Style Qtach	BO500	A
902 Qtach	CA902	A
902C2 Skidsteer Style Qtach	BO500	A
903C Skidsteer Style Qtach	BO500	A
903C2 Skidsteer Style Qtach	BO500	A
904B Skidsteer Style Qtach	BO500	A
904H Skidsteer Style Qtach	BO500	A
906 Skidsteer Style Qtach	CA902	A
906H Hook Style Qtach	CA907	D+305
906H Skidsteer Style Qtach	BO500	A
906H2 Skidsteer Style Qtach	BO500	A
906M Hook Style Qtach	CA907	D+305
906M Skidsteer Style Qtach	BO500	A
907H Hook Style Qtach	CA907	D+305
907H Skidsteer Style Qtach	BO500	A
907H2 Hook Style Qtach	CA907	D+305
907H2 Skidsteer Style Qtach	BO500	A
907M Hook Style Qtach	CA907	D+305
907M Skidsteer Style Qtach	BO500	A
908 Qtach	CA902	A
908H Hook Style Qtach	CA907	D+305
908H Skidsteer Style Qtach	BO500	A
908H2 Hook Style Qtach	CA907	D+305
908H2 Skidsteer Style Qtach	BO500	A
908M Hook Style Qtach	CA907	D+305
908M Skidsteer Style Qtach	BO500	A
910K ISO Coupler	VOL50Q	D+305
910K IT Coupler	CAIT24	D+305
910M ISO Coupler	VOL50Q	D+305
910M IT Coupler	CAIT24	D+305
914G IT Coupler	CAIT24	D+305
914G2 IT Coupler	CAIT24	D+305
914K ISO Coupler	VOL50Q	D+305
914K IT Coupler	CAIT24	D+305
914M ISO Coupler	VOL50Q	D+305
914M IT Coupler	CAIT24	D+305
918K ISO Coupler	VOL50Q	D+305
918K IT Coupler	CAIT24	D+305
918M ISO Coupler	VOL50Q	D+305

918M IT Coupler	CAIT24	D+305
924H IT Coupler	CAIT24	D+305
924H Fusion Qtach	CAFU	D+549
924K Fusion Qtach	CAFU	D+549
930K Fusion Qtach	CAFU	D+549
938K Fusion Qtach	CAFU	D+549
TL943 Qtach	CAIT24	D+305
950G Qtach	CA950GQ	D+549
Cat Fusion Qtach	CAFU	D+549

Direct To Loader Boom Mounts		
906 Direct	CA906	D+305
906M Direct	CA906M	D+305
414E Direct	CA416	D+305
416D Direct	CA416	D+305
420D Direct	CA416	D+305
420E Direct	CA416	D+305
420F Single Cyl Direct	CA430F	D+305
420XE Single Cyl Direct	CA430F	D+305
424D Direct	CA416	D+305
426C Direct	CA416	D+305
428D Direct	CA416	D+305
430D Direct	CA416	D+305
430F Single Cyl Direct	CA430F	D+305
450E Direct	CA450E	D+305
450F Direct	CA450E	D+305
914G Direct	CA914G	D+305
924G Direct	CA924G	D+305
924H Direct	CA924G	D+305
928F Direct	CA928FD	D+305
928Hz Direct	CA928HZ	D+305
938G Direct	CA938G	D+305
950C Direct	CA950	D+305
966H Direct	CA966H	D+549

Century	Part #	Price Code
Century 50 Qtach	CE50	A
Century 50HL Qtach	BO500	A

Challenger	Part #	Price Code
Quick Attach Mounts		
ML21 Qtach	AO600	A
ML26 Qtach	AO600	A
ML31 Qtach	AO600	A
ML33 Qtach	AO600	A
ML36 Qtach	AO600	A
ML38 Qtach	AO600	A
ML40B Hook Type Qtach	FNAO600	A
ML40B Skidsteer Qtach	BO500	A
ML41 Qtach	AO600	A
ML46 Qtach	AO600	A
ML48 Qtach	AO600	A
ML49 Qtach	AO600	A
ML51 Qtach	AO600	A
ML56 Qtach	AO600	A
ML58 Qtach	AO600	A
ML61 Qtach	AO600	A
ML66 Qtach	AO600	A
ML68 Qtach	AO600	A
72B Qtach	AO600	A
ML72 Qtach	AO600	A
73B Qtach	AO600	A
74B Qtach	AO600	A

Loader Order Mounting Codes

ML75 Qtach	AO600	A
ML76 Qtach	AO600	A
77B Qtach	AO600	A
ML77 Qtach	AO600	A
ML78 Qtach	AO600	A
ML88 Qtach	AO600	A
92B Qtach	AO600	A
ML92 Qtach	AO600	A
93B Qtach	AO600	A
94B Qtach	AO600	A
ML94 Qtach	AO600	A
ML96 Qtach	AO600	A
97B Qtach	AO600	A
ML97 Qtach	AO600	A
98B Qtach	AO600	A
ML98 Qtach	AO600	A
99B Qtach	AO600	A
Direct To Loader Boom Mounts		
ML10B Direct	MF1464	B
ML20 Direct	MF1464	B
ML20B Direct	MF1464	B
ML30 Direct	MF1466	B
ML30B Direct	MF1466	B
ML21 Direct	AOQ55DM	B
ML26 Direct	AOQ55DM	B
ML31 Direct	AOQ55DM	B
ML33 Direct	AOQ55DM	B
ML36 Direct	AOQ55DM	B
ML38 Direct	AOQ55DM	B
ML40 Direct	MF1040	B
ML40B Direct	MFDL260	B
ML41 Direct	AOQ55DM	B
ML46 Direct	AOQ55DM	B
ML48 Direct	AOQ55DM	B
ML49 Direct	AOQ55DM	B
ML51 Direct	AOQ55DM	B
ML56 Direct	AOQ55DM	B
ML58 Direct	AOQ55DM	B
ML61 Direct	AOQ55DM	B
ML66 Direct	AOQ55DM	B
ML68 Direct	AOQ55DM	B
ML72 Direct	AO660	B
ML72B DM Direct up to S# 7282198	AOQ55DM	B
ML72B US Direct	AOQ40US	B
ML73B DM Direct up to S# 7282198	AOQ55DM	B
ML73B US Direct	AOQ40US	B
ML74B DM Direct up to S# 7282198	AOQ55DM	B
ML74B US Direct	AOQ40US	B
ML75 Direct	AO660	B
ML75B DM Direct up to S# 7282198	AOQ55DM	B
ML75B US Direct	AOQ40US	B
ML76 Direct	AOQ55DM	B
ML77 Direct	AO675	B
ML77B DM Direct up to S# 7282198	AOQ55DM	B
ML78 Direct	AOQ55DM	B
ML88 Direct	AOQ55DM	B
ML92 Direct	AO660	B
ML92B DM Direct up to S# 7282198	AOQ55DM	B
ML92B US Direct	AOQ40US	B
ML93B DM Direct up to S# 7282198	AOQ55DM	B
ML93B US Direct	AOQ40US	B
ML94 Direct	AO660	B

ML94B DM Direct up to S# 7282198	AOQ55DM	B
ML94B US Direct	AOQ40US	B
ML95B DM Direct up to S# 7282198	AOQ55DM	B
ML95B US Direct	AOQ40US	B
ML96 Direct	AO675	B
ML97 Direct	AO675	B
ML97B DM Direct up to S# 7282198	AOQ55DM	B
ML98 Direct	AO675	B
ML98B DM Direct up to S# 7282198	AOQ55DM	B

Cheng Gong	Part #	Price Code
938H Qtach	CG948HQ	D+549
948H Qtach	CG948HQ	D+549
957H Qtach	CG957HQ	D+549

Cub Cadet	Part #	Price Code
Quick Attach Mounts		
CL200 Qtach	CCCL200Q	B
Direct To Loader Boom Mounts		
CL100 Direct (1" cyl pin)	CCCL100A	B
CL100 Direct (1.25" cyl pin)	CCCL100B	B
CL200 Direct	CCCL200	B
CL300 Direct (2008 and earlier)	CCCL300	B
CL400 Direct	CCCL400	B
417 Direct	CC417	B
476 Direct	CC476	B

David Brown	Part #	Price Code
LF8H Direct	DBLF8H	C
LF12 Direct	DBLF8H	C
55 Direct	DB55	B
74L Direct	DB74L	B
990 Direct	DB990	B
995 Direct	DB995	B

Deutz Allis	Part #	Price Code
455 Direct	DA455	B
455R Direct	DA455	B
456 Direct	DA455	B
465 Direct	DA455	B
466 Direct	DA455	B
Fiat Allis 840 Direct	FA840	D

Dieci	Part #	Price Code
5.519 Extreme Qtach	DCAO	D+305
Apollo 25.6 Qtach	DCAO	D+305
Dedalus 30.7 Qtach	DCAGP	D+549
Agri Tech 32.9VS Qtach	DCAGP	D+549
Zeus 33.11 Qtach	DCAGP	D+549
Pegasus 35.16 Qtach	DCRNR	D+549
Agri Tech 35.7VS Qtach	DCAGP	D+549
Zeus 37.7 Qtach	DCAGP	D+549
Zeus 38.10 Qtach	DCAGP	D+549
Runner 40.13 Qtach	DCRNR	D+549
Icarus 40.17 Qtach	DCRNR	D+549
Pegasus 40.25 Qtach	DCRNR	D+549
Agri Plus 40.7H Qtach	DCAGP	D+549
Samson 45.8 Qtach	DCRNR	D+549
Pegasus 50.21 Qtach	DCRNR	D+549
Pegasus 60.16 Qtach	DCRNR	D+549
Samson 65.8 Qtach	DCSMSN	D+549
Agri Max 65.8 Qtach	DCSMSN	D+549

Loader Order Mounting Codes

Samson 70.10 Qtach	DCSMSN	D+549
Hercules 120.10 Qtach	DCH	D+549
Hercules 160.10 Qtach	DCH	D+549
Hercules 210.10 Qtach	DCH	D+549

Duall	Part #	Price Code
115 Qtach	DU115	B
215 Qtach	DU115	B

Dunham Lehr	Part #	Price Code
22 Direct	DL22	C
24 Direct	DL24	B

Ezee-On	Part #	Price Code
2070 Qtach	EZ2070	D

Faresin	Part #	Price Code
626S Qtach	FAR600	B
630C Qtach	FAR600	B
730C Qtach	FAR600	B
930C Qtach	FAR600	B
730M Qtach	FAR600	B
735M Qtach	FARSN	D+305
745M Qtach	FARSN	D+305
840M Qtach	FARSN	D+305
930M Qtach	FARSN	D+305
1135M Qtach	FARSN	D+305
960HD Qtach	FARHD	D+549
970HD Qtach	FARHD	D+549
1065HD Qtach	FARHD	D+549
1042BR Qtach	FARSN	D+305
1740BR Qtach	FARSN	D+305
1745BR Qtach	FARSN	D+305

Farmhand	Part #	Price Code
Quick Attach Mounts		
XL740 Qtach	FHXL740	B
XL940 Qtach	FHXL740	B

Direct To Loader Boom Mounts		
F258 Direct	FH258	B
FH222 Direct	MF1040	B
490 Direct	FH490	B

Fendt	Part #	Price Code
Quick Attach Mounts		
North American Qtach	FNAO600	A
555 Qtach	AO600	A
655 Qtach	AO600	A

Direct To Loader Boom Mounts		
4X75 Direct	FT4X85D	B
4X80 Direct	FT4X85D	B
4X85 Direct	FT4X85D	B
4X90 Direct	FT4X85D	B
5X85 Direct	FT4X85D	B
555 Direct	AOQ55DM	B
655 Direct	AOQ55DM	B
685 Direct	AOQ55DM	B
755 Direct	AOQ55DM	B
785 Direct	AOQ55DM	B
855 Direct	AOQ55DM	B
885 Direct	AOQ55DM	B

Force	Part #	Price Code
Quick Attach Mounts		
2045 Skidsteer Style Qtach	BO500	A
2347 Skidsteer Style Qtach	BO500	A
2427 Skidsteer Style Qtach	BO500	A
2447 Skidsteer Style Qtach	BO500	A
2847 Skidsteer Style Qtach	BO500	A
3045 Skidsteer Style Qtach	BO500	A
3227 Skidsteer Style Qtach	BO500	A
3545 Skidsteer Style Qtach	BO500	A
4045 Skidsteer Style Qtach	BO500	A
5045 Skidsteer Style Qtach	BO500	A
6045 Skidsteer Style Qtach	BO500	A

Direct To Loader Boom Mounts		
3045 Direct	FC4045	B
3545 Direct	FC4045	B
4045 Direct	FC4045	B
5045 Direct	FC4045	B
6045 Direct	FC4045	B

Ford (Ag)	Part #	Price Code
Quick Attach Mounts		
256 Qtach	FO276	C
276 Qtach	FO276	C
2360V Qtach	FO276	C
7210 Qtach	FO7310Q	B
7309 Qtach	FO7310Q	B
7310 Qtach	FO7310Q	B
7312 Qtach	FO7411Q	C
7314 Qtach	FO7411Q	C
7410 Qtach	FO7310Q	B
7411 Qtach	FO7411Q	C
7412 Qtach	FO7411Q	C
7413 Qtach	FO7411Q	C
7414 Qtach	FO276	C
7511 Qtach	FO7411Q	C
7514 Qtach	FO7514Q	C

Direct To Loader Boom Mounts		
A62 Direct	FOA62	D
276 Direct	FO276D	C
340 Direct	FO340B	B
340A Direct	FO340B	B
340B Direct	FO340B	B
345C Direct	FO345D	D
345D Direct	FO345D	D
455 Direct	FO455	B
727 Direct	FO727	B
730 Direct	FO730	B
768 Direct	FO770	B
768A Direct	FO770	B
768B Direct	FO770	B
770A Direct	FO770	B
770B Direct	FO770	B
771 Compact Direct	FO770	B
772 Direct	FO772	B
775 Direct	FO775	B
776 Direct	FO772	B
777A Direct	FO777A	B
777B Direct	FO777B	B
777F Direct	FO777F	B

Loader Order Mounting Codes

7106 Direct	FO7308	B
7108 Direct	FO7108	B
7109 Direct	FO7109	B
7209 Direct	FO7310	B
7210 Direct	FO7310	B
7308 Direct	FO7308	B
7309 Direct	FO7310	B
7310 Direct	FO7310	B
7312 Direct	FO7312	B
7410 Direct	FO7310	B
7411 Direct	FO7411D	B
7412 Direct	FO7411D	B
7413 Direct	FO7411D	B
7511 Direct	FO7411D	B
7414D Direct	FO7414D	B
7500 Direct	FO7500	B

Ford (Industrial)	Part #	Price Code
LB110 Ind Direct	FO575E	D
LB190 Ind Direct	FO575E	D
340 Direct	FO340B	B
340A Direct	FO340B	B
340B Direct	FO340B	B
345C Direct	FO345D	D
345D Direct	FO345D	D
445A Ind Direct	FO445A	C
445C Ind Direct	FO445C	C
445D Ind Direct	FO445D	C
455 Ind Direct	FO455IND	D
533 Ind Direct	FO533	D
545 Ind Direct	FO545	D
545C Ind Direct	FO545C	D
545D Ind Direct (After 1982)	FO545D	D
545D Ind Direct (1979 - 1982)	FO545DO	D
550 Ind Direct	FO555A	D
555 Ind Direct	FO555A	D
555A Ind Direct	FO555A	D
555B Ind Direct	FO555B	D
555C Ind Direct	FO555D	D
555D Ind Direct	FO555D	D
555E Ind Direct	FO575E	D
575E Ind Direct	FO575E	D
575D Ind Direct	FO555D	D
655A Ind Direct	FO555A	D
655C Ind Direct	FO555D	D
655D Ind Direct	FO555D	D
655E Ind Direct	FO575E	D
675D Ind Direct	FO555D	D
675E Ind Direct	FO575E	D
735 Ind Direct	FO735	B
744 Ind Direct	FO744	B
745 Ind Direct	FO745	B
4500 Ind Direct	FO4500	B

Freeman	Part #	Price Code
3000 Direct	FR3000	C
4000 Direct	FR4000	B

Frey	Part #	Price Code
Quick Attach Mounts		
Qtach	HOQF	A
190A Qtach	FRE750	A

360 Qtach	FRE750	A
500 Qtach	FRE750	A
ML665 Euro Qtach	AO600	A
ML665 Skidsteer Qtach	BO500	A
750 Qtach	FRE750	A
HR1100 Euro Qtach	AO600	A
HR1100 Skidsteer Qtach	BO500	A
HR1120 Euro Qtach	AO600	A
HR1120 Skidsteer Qtach	BO500	A
HR1130 Euro Qtach	AO600	A
HR1130 Skidsteer Qtach	BO500	A
ML6130 Euro Qtach	AO600	A
ML6130 Skidsteer Qtach	BO500	A

Direct To Loader Boom Mounts

20 Direct	FRE160	B
40 Direct	FRE180	B
160 Direct	FRE160	B
165 Direct	FRE160	B
180 Direct	FRE180	B
200 Direct	FRE200	B
280 Direct	FRE280	B
ML360 Direct	FREML500	B
460 Direct	FRE460	B
461 Direct	FRE461	B
465 Direct	FREHR1100	B
ML500 Direct	FREML500	B
560 Direct	FRE460	B
565 Direct	FREHR1100	B
ML665 Direct	FREML665	B
ML750 Direct	FRE750D	B
60-10 Direct	FRE280	B
75-10 Direct	FRE460	B
75-15 Direct	FRE460	B
75-20 Direct	FRE7520	B
75-30 Direct	FRE7520	B
80-10 Direct	FRE8010	B
80-10N Direct	FRE8010	B
85-10 Direct	FRE460	B
80-30 Direct	FRE7520	B
85-20 Direct	FRE7520	B
85-30 Direct	FRE7520	B
UN9000 Direct	FRE8010	B
HR1100 Direct	FREHR1100	B
HR1120 Direct	FREHR1100	B
HR1130 Direct	FREHR1100	B
ML6130 Direct	FREML665	B

Gehl	Part #	Price Code
AWS 36 Qtach	GE480	D+305
340 Skidsteer Qtach	BO500	A
480 Qtach	GE480	D+305
650 Skidsteer Qtach	CA902	A
680 Qtach	GE680	D+305
750 Skidsteer Qtach	CA902	A
RS 6-34 Dynattach	GEDY519	C
RS 6-42 Dynattach	GEDY642	C
RS 8-42 Dynattach	GEDY642	C
RS 8-44 Dynattach	GEDY642	C
AWS 46 Qtach	GE680	D+305
RS 5-19 Dynattach	GEDY519	C

Loader Order Mounting Codes

Genie	Part #	Price Code
5519 Qtach	TX5119	D
Giant	Part #	Price Code
Quick Attach Mounts		
Giant 254 SW Qtach	GID254SW	A
Giant V6004T Qtach	BO500	A
Direct To Loader Boom Mounts		
Giant V6004T Direct	GIV6004T	C
Great Bend	Part #	Price Code
Quick Attach Mounts		
M110 Qtach	GB870Q	B
330 Qtach	GB870Q	B
360 Qtach	GB870Q	B
440 Qtach	GB870Q	B
660 Qtach	GB870Q	B
760 Qtach	GB870Q	B
770 Qtach	GB870Q	B
860 Qtach	GB870Q	B
870 Qtach	GB870Q	B
880 Qtach	GB870Q	B
2140 Qtach	GB870Q	B
2144 Qtach	GB870Q	B
2157 Qtach	GB870Q	B
2166 Qtach	GB870Q	B
3424 Qtach	GB870Q	B
Direct To Loader Boom Mounts		
660 Direct	GB660	B
880 Direct	GB880	B
2805 Direct	GB2805	B
Hardy	Part #	Price Code
Quick Attach Mounts		
25 Qtach	HA35QT	C
35 Qtach	HA35QT	C
45 Qtach	HA85QT	C
55 Qtach	HA85QT	C
65 Qtach	HA85QT	C
85DL Qtach	HA85QT	C
105 Qtach	HA85QT	C
115 Qtach	HA85QT	C
135 Qtach	HA85QT	C
Direct To Loader Boom Mounts		
45 Direct	HA55DL	B
55DL Direct	HA55DL	B
65DL Direct	HA65DL	B
65ST Direct	HA65ST	B
HUNIK 100 Direct	HAHU100	B
80 Direct	HA80	B
85DL Direct	HA85DL	B
85ST Direct	HA85ST	B
100 Direct	HA100	B
105DL Direct	HA115DL	B
115DL Direct	HA115DL	B
Hesston	Part #	Price Code
315 Direct	DA455	B
L335 Direct	DA455	B
L330 Direct	HD330	B

Horst	Part #	Price Code
Quick Fit	HOQF	A
Ind Quick Fit (tractor loader backhoe)	HDQF	D+305
Ind Quick Fit (wheel loader)	HDQFWL	D+549
Hyundai	Part #	Price Code
Quick Attach Mounts		
HL730TM-3 Qtach	HYHL740TM7	D+549
HL730TM-7 Qtach	HYHL740TM7	D+549
HL730TM-9 Qtach	HYHL740TM7	D+549
HL730TM-9A Qtach	HYHL740TM7	D+549
HL740TM-3 Qtach	HYHL740TM7	D+549
HL740TM-7 Qtach	HYHL740TM7	D+549
HL740TM-9 Qtach	HYHL740TM7	D+549
HL740TM-9A Qtach	HYHL740TM7	D+549
HL757TM-7 Qtach	HYHL757TM7	D+305
HL757TM-9 Qtach	HYHL757TM7	D+305
HL757TM-9A Qtach	HYHL757TM7	D+305
HL935TM Qtach	HYHL740TM7	D+549
HL940TM Qtach	HYHL740TM7	D+549
HL955TM Qtach	HYHL757TM7	D+305
Direct To Loader Boom Mounts		
HL730-3 Z-Bar Direct	HYHL7303	D+305
HL730-7A Z-Bar Direct	HYHL7303	D+305
HL730-9 Z-Bar Direct	HYHL7303	D+305
HL730-9A Z-Bar Direct	HYHL7303	D+305
HL730-9S Z-Bar Direct	HYHL7303	D+305
HL740-3 Z-Bar Direct	HYHL7403	D+305
HL740-7A Z-Bar Direct	HYHL7403	D+305
HL740-9 Z-Bar Direct	HYHL7403	D+305
HL740-9A Z-Bar Direct	HYHL7403	D+305
HL740-9S Z-Bar Direct	HYHL7403	D+305
HL750 Z-Bar Direct	HYHL750	D+305
HL757-7A Z-Bar Direct	HYHL7577	D+549
HL757-9 Z-Bar Direct	HYHL7577	D+549
HL757-9A Z-Bar Direct	HYHL7577	D+549
HL760 Z-Bar Direct	HYHL760	D+549
HL760-7A Z-Bar Direct	HYHL7607	D+549
HL760-9 Z-Bar Direct	HYHL7607	D+549
HL760-9A Z-Bar Direct	HYHL7607	D+549
HL770 Z-Bar Direct	HYHL770	D+549
HL770-7A Z-Bar Direct	HYHL7707	D+549
HL770-9 Z-Bar Direct	HYHL7707	D+549
HL770-9A Z-Bar Direct	HYHL7707	D+549
HL780-9 Z-Bar Direct	HYHL7809	D+793
HL780-9A Z-Bar Direct	HYHL7809	D+793
Ingersoll-Rand	Part #	Price Code
VR843 Qtach	IRVR843	D+305
JCB	Part #	Price Code
Quick Attach Mounts		
TLT35D Changezee Qtach	JCCHZE	D+305
3CX Compact Qtach	JC212	D
3CX-14 Qtach	JC214Q	D
3CX-14 Super Qtach	JC214Q	D
3CX-15 Qtach	JC214Q	D
3CX-17 Super Qtach	JC214Q	D
4CX-14 Super Qtach	JC214Q	D
4CX-15 Super Qtach	JC214Q	D
4CX-17 Super Qtach	JC214Q	D

Loader Order Mounting Codes

210 Qtach	JC212	D
212 Qtach	JC212	D
214 Site Master Qtach	JC214Q	D
TM180 Qtach	JC520	D
TM180 Ag Style Qtach	AO600	A
TM220 Qtach	JC520	D
TM220 Ag Style Qtach	AO600	A
TM310 Qtach	JC530B	D
TM310 Qtach (optional wide carriage)	JC530BW	D
TM320 Qtach	JC530B	D
TM320 Qtach (optional wide carriage)	JC530BW	D
TM420 Qtach	JC530B	D
TM420 Qtach (optional wide carriage)	JC530BW	D
406 Hook Style Qtach	JC406	D+305
407 Hook Style Qtach	JC406	D+305
407 Skidsteer Style Qtach	BO500	A
409 Skidsteer Style Qtach	BO500	A
416 Qtach	VOL50Q	D+305
426 Qtach	VOL50Q	D+305
436 Qtach	VOL50Q	D+305
437 Qtach	VOL50Q	D+305
504B Qtach	JC526	D+305
505-19 Qtach	JC530B	D
505-19 Qtach (optional wide carriage)	JC530BW	D
505-22 Qtach	JC530B	D
505-22 Qtach (optional wide carriage)	JC530BW	D
506 Qtach	JC508	D
508 Qtach	JC508	D
507-42 Qtach	JC50942	D
509-42 Qtach	JC50942	D
510-40 Qtach	JC530B	D
510-40 Qtach (optional wide carriage)	JC530BW	D
510-56 Qtach	JC50942	D
512-56 Qtach	JC50942	D
504-13 Qtach (Skidsteer Carrier) Qtach	BO500	A
505-20 (Skidsteer Carrier) Qtach	BO500	A
515-40 Qtach (Skidsteer Carrier) Qtach	BO500	A
520 Qtach	JC520	D
524-50 Qtach	JC520	D
525-60 Q-Fit Qtach	JC530B	D
525-60 (Skidsteer Carrier) Qtach	BO500	A
525-60 (Euro Carrier) Qtach	AO600	A
526 Qtach	JC526	D+305
527-58 Qtach	JC530B	D
527-58 Qtach (optional wide carriage)	JC530BW	D
530 Qtach	JC530B	D
530 Qtach (optional wide carriage)	JC530BW	D
530B Qtach	JC530B	D
530B Qtach (optional wide carriage)	JC530BW	D
536-60 Qtach	JC530B	D
536-60 Qtach (optional wide carriage)	JC530BW	D
540 Qtach	JC530B	D
540 Qtach (optional wide carriage)	JC530BW	D
541-70 Qtach	JC530B	D
541-70 Qtach (optional wide carriage)	JC530BW	D
560-80 Qtach	JC530B	D
560-80 Qtach (optional wide carriage)	JC530BW	D
MIDLcx Qtach	BO500	A
Direct To Loader Boom Mounts		
3CX Direct	JC214	D
3CX Compact Direct	JC3CXC	D
4CX Direct	JC214	D

214 Direct	JC214	D
215 Direct	JC214	D
217 Direct	JC214	D
TM180 Direct	JCTM220D	D+305
TM220 Direct	JCTM220D	D+305
TM320 Direct	JCTM320D	D+305
407 Direct	JC407D	D+305
409 Direct	JC409D	D+549
410 HT Direct	JC410ZXD	D
411 HT Direct	JC411HTD	D
417 HT Direct	JC411HTD	D
426 HT Direct	JC426HTD	D
426 ZX Direct	JC436ZXD	D
436 HT Direct	JC426HTD	D
436 ZX Direct	JC436ZXD	D
446 ZX Direct	JC446ZXD	D+305
456 ZX Direct	JC446ZXD	D+305
456 HT Direct	JC456HTD	D+305
504-13 Direct	JC50413D	D
515-40 Direct	JC51540D	D
505-20 Direct	JC52560D	D
525-60 Direct	JC52560D	D
527-55 Direct	JC52755D	D+305
2145 Direct	JC2145	D

JLG	Part #	Price Code
JLG G5-19 Qtach	JLG623	D+305
JLG G6-23 Qtach	JLG623	D+305
JLG 9-43 Qtach Serial# 0 - 0160037670	JLG943A	D+549
JLG 9-43A Qtach Serial# 0160037671 - end	JLG943AN	D+549

John Deere (Ag)	Part #	Price Code
Quick Attach Mounts		
1570 TerrainCut Front Mower	JD15FH	C
1575 TerrainCut Front Mower	JD15FH	C
1585 TerrainCut Front Mower	JD15FH	C
D120 (400 Style Carrier) Qtach	JD440	A
H120 (400 Style Carrier) Qtach	JD440	A
120R (400 Style Carrier) Qtach	JD440	A
H130 (400 Style Carrier) Qtach	JD440	A
D160 (400 Style Carrier) Qtach	JD440	A
H160 (400 Style Carrier) Qtach	JD440	A
H165 (400 Style Carrier) Qtach	JD440	A
H165 (Skidsteer Carrier) Qtach	BO500	A
D170 (400 Style Carrier) Qtach	JD440	A
H180 (400 Style Carrier) Qtach	JD440	A
H180 (Skidsteer Carrier) Qtach	BO500	A
200 CX (400 Style Carrier) Qtach	JD440	A
200 X (400 Style Carrier) Qtach	JD440	A
210 (400 Style Carrier) Qtach	JD440	A
220R (400 Style Carrier) Qtach	JD440	A
240 Qtach	JD245	A
245 Qtach	JD245	A
H260 (Global Carrier) Qtach	AO600	A
H260 (500 Style Carrier) Qtach	JD540	A
H260 (Skidsteer Carrier) Qtach	BO500	A
260 Qtach	JD245	A
265 Qtach	JD245	A
280 Qtach	JD280	B
300 CX (400 Style Carrier) Qtach	JD440	A
300 CX (Skidsteer Carrier) Qtach	BO500	A
300E (400 Style Carrier) Qtach	JD440	A

Loader Order Mounting Codes

300 X (400 Style Carrier) Qtach	JD440	A
300 X (Skidsteer Carrier) Qtach	BO500	A
305 (400 Style Carrier) Qtach	JD440	A
H310 Qtach	AO600	A
H310 (500 Style Carrier) Qtach	JD540	A
H310 (Skidsteer Carrier) Qtach	BO500	A
320R (400 Style Carrier) Qtach	JD440	A
320R (Skidsteer Carrier) Qtach	BO500	A
H340 Qtach	AO600	A
H360 Qtach	AO600	A
H380 Qtach	AO600	A
400 CX Qtach	JD440	A
400E (400 Style Carrier) Qtach	JD440	A
400 X Qtach	JD440	A
410 Qtach	JD440	A
419 Qtach	JD440	A
420 Qtach	JD440	A
430 Qtach	JD440	A
440 Qtach	JD440	A
440R (400 Style Carrier) Qtach	JD440	A
440R (Skidsteer Carrier) Qtach	BO500	A
460 Qtach	JD440	A
H480 Qtach (Global 2 Carrier)	JDH480	C
510 Qtach	JD440540	A
512 Qtach	JD440540	A
520 Qtach	JD440540	A
520M (Global Carrier) Qtach	AO600	A
520M (500 Style Carrier) Qtach	JD440540	A
520M (Skidsteer Carrier) Qtach	BO500	A
521 Qtach	JD440540	A
522 Qtach	JD440540	A
540 Qtach	JD440540	A
540 SL Qtach	JD440540	A
540M (Global Carrier) Qtach	AO600	A
540M (500 Style Carrier) Qtach	JD440540	A
540M (Skidsteer Carrier) Qtach	BO500	A
540R (Global Carrier) Qtach	AO600	A
540R (500 Style Carrier) Qtach	JD440540	A
540R (Skidsteer Carrier) Qtach	BO500	A
541 Qtach	JD440540	A
542 Qtach	JD440540	A
553 (Global Carrier) Qtach	AO600	A
553 (500 Style Carrier) Qtach	JD440540	A
553 (Skidsteer Carrier) Qtach	BO500	A
562 (Global Carrier) Qtach	AO600	A
562 (500 Style Carrier) Qtach	JD440540	A
562 (Skidsteer Carrier) Qtach	BO500	A
563 (Global Carrier) Qtach	AO600	A
563 (500 Style Carrier) Qtach	JD440540	A
563 (600 Style Carrier) Qtach	JD640	C
563 (Skidsteer Carrier) Qtach	BO500	A
620 Qtach	JD640	C
600R (Global Carrier) Qtach	AO600	A
620R (Global Carrier) Qtach	AO600	A
640 Qtach	JD640	C
640R (Global Carrier) Qtach	AO600	A
660R (Global Carrier) Qtach	AO600	A
673 (Global Carrier) Qtach	AO600	A
673 (600 Style Carrier) Qtach	JD640	C
673 (Skidsteer Carrier) Qtach	BO500	A
680R (Global Carrier) Qtach	AO600	A
700M Qtach (Global 2 Carrier)	JDH480	C
720 Qtach	JD640	C

725 Qtach	JD640	C
740 Qtach	JD640	C
741 (Global Carrier) Qtach	AO600	A
741 (700 Style Carrier) Qtach	JD640	C
746 (Global Carrier) Qtach	AO600	A
746 (800 Style Carrier) Qtach	JD840	C
746 (700 Style Carrier) Qtach	JD640	C
840 Qtach	JD840	C
843 Qtach	JD840	C
3200 Telehandler Qtach	JD3400	D
3400 Telehandler Qtach	JD3400	D
3800 Telehandler Qtach	JD3400	D

Direct To Loader Boom Mounts

36 Direct	JD36	C
37 Direct	JD37	C
38 Direct	JD38	C
45 Direct	JD45	B
46A Direct	JD46A	C
47 Direct	JD46A	C
48 Direct	JD48	C
58 Direct	JD48	C
67 Direct	JD67	B
70 Direct	JD70	B
70A Direct	JD70	B
75 Direct	JD75	B
80 Direct	JD80	B
100 Direct	JD100	B
110 Direct	JD110	B
D120 Direct	JD300X	B
H120 Direct	JD300X	B
120R MSL Direct	JD400X	B
120R NSL Direct	JD300X	B
H130 Direct	JD300X	B
143 Direct	JD143	C
145 Direct	JD145	B
146 Direct	JD146	B
148 Direct	JD146	B
158 Direct	JD146	B
D160 Direct	JD300X	B
H160 Direct	JD300X	B
H165 Direct	JD400X	B
D170 Direct	JDD170	B
175 Direct	JD175	B
H180 Direct	JD400X	B
200X Direct	JD300X	B
200CX Direct	JD300X	B
220R MSL Direct	JD400X	B
220R NSL Direct	JD300X	B
H240 Direct	JDH240	B
245 Direct	JD245D	D
260 Direct	JD260L	B
H260 Direct	JDH340	B
265 Direct	JD265	B
300 Direct	JD300X	B
300CX Direct	JD400X	B
300E MSL Direct	JD400X	B
300E NSL Direct	JD300X	B
300R Direct	JD300X	B
300X Direct	JD300X	B
305 Direct	JD300X	B
H310 Direct	JDH340	B
320R Direct	JD400X	B

Loader Order Mounting Codes

H340 Direct	JDH340	B
H360 Direct	JDH380	B
H380 Direct	JDH380	B
400CX Direct	JD400X	B
400E Direct	JDD170	B
400X Direct	JD400X	B
419 Direct	JD419D	B
420 Direct	JD419D	B
430 Direct	JD419D	B
440 Direct	JD440D	B
460 Direct	JD419D	B
440R MSL Direct	JD400X	B
440R NSL Direct	JD400X	B
H480 Direct	JDH480D	C
520 NSL Direct	JD540D	B
520M Direct	JDH240	B
521 NSL Direct	JD540D	B
522 Direct	JD540D	B
540 NSL Direct	JD540D	B
540 SL Direct	JD541SL	B
540M Direct	JDH340	B
540R Direct	JD540R	B
541 NSL Direct	JD541SL	B
541 SL Direct	JD541SL	B
542 NSL Direct	JD541SL	B
542 SL Direct	JD541SL	B
553 Direct	JD553D	B
562 SL Direct	JD563	B
563 NSL Direct	JD563	B
563 SL Direct	JD563	B
600R Direct	JD600R	B
620 NSL Direct	JD620NSL	B
620 SL Direct	JD620SL	B
620R NSL Direct	JD620R	B
620R SL Direct	JD620R	B
640 NSL Direct	JD620NSL	B
640 SL Direct	JD620SL	B
640R NSL Direct	JD640R	C
640R SL Direct	JD640R	C
660R NSL Direct	JD640R	C
660R SL Direct	JD640R	C
673 NSL Direct	JD563	B
673 SL Direct	JD563	B
680R NSL Direct	JD640R	C
680R SL Direct	JD640R	C
700M Direct	JDH480D	C
720 NSL Direct	JD620NSL	B
720 SL Direct	JD620SL	B
725 NSL Direct	JD620NSL	B
725 SL Direct	JD620SL	B
740 NSL Direct	JD740NSL	B
740 SL Direct	JD740SL	B
741 NSL Direct	JD741	C
741 SL Direct	JD741	C
746 Direct	JD741	C
840 Direct	JD843D	C
843 Direct	JD843D	C

John Deere (Industrial)	Part #	Price Code
Quick Attach Mounts		
TL110 Skidsteer Qtach	BO500	A
204K Skidsteer Qtach	BO500	A

210C Qtach	JD210C	D
244E Qtach	JD244EQ	D+305
244J Qtach	JD244J	D+305
244K Skidsteer Qtach	BO500	A
244K ISO Qtach	JD244J	D+305
244L Skidsteer Qtach	BO500	A
244L ISO Qtach	JD244J	D+305
304H ISO Qtach	JD244J	D+305
304J ISO Qtach	JD244J	D+305
304K Skidsteer Qtach	BO500	A
304K ISO Qtach	JD244J	D+305
304L Skidsteer Qtach	BO500	A
304L ISO Qtach	JD244J	D+305
310G Qtach	JRBE	D+305
310SG Qtach	JRBE	D+305
310SK Qtach	JRBE	D+305
310J Qtach	JRBE	D+305
310SJ Qtach	JRBE	D+305
310SJ TC Qtach	JRBE	D+305
310K Qtach	JRBE	D+305
310K EP Qtach	JRBE	D+305
310L Qtach	JRBE	D+305
310SL Qtach	JRBE	D+305
310SL HL Qtach	JRBE	D+305
324J Qtach	JD244J	D+305
324K Skidsteer Qtach	BO500	A
324K ISO Qtach	JD244J	D+305
324L Skidsteer Qtach	BO500	A
324L ISO Qtach	JD244J	D+305
344H Highvis Qtach	VOL50Q	D+305
344J Highvis Qtach	VOL50Q	D+305
344K Highvis Qtach	VOL50Q	D+305
344L Highvis Qtach	VOL50Q	D+305
410G Ind Qtach	JRBE	D+305
410J Ind Qtach	JRBE	D+305
410K Ind Qtach	JRBE	D+305
410L Ind Qtach	JRBE	D+305
444H Ind Qtach	JRB416	D+549
444J Ind Qtach	JRB416	D+549
444J Highvis Qtach	VOL50Q	D+305
444K Ind Qtach	JRB416	D+549
444K Highvis Qtach	VOL50Q	D+305
524K Highvis Qtach	VOL50Q	D+305
524K Ind Qtach	JRB416	D+549
544E Ind Qtach	JRB416	D+549
544G Ind Qtach	JRB416	D+549
544H Ind Qtach	JRB416	D+549
544J Ind Qtach	JRB416	D+549
544J Highvis Qtach	VOL50Q	D+305
544K Ind Qtach	JRB416	D+549
544K Highvis Qtach	VOL50Q	D+305
624J Ind Qtach	JRB416	D+549
624K Ind Qtach	JRB416	D+549
624J Highvis Qtach	VOL50Q	D+305
624K Highvis Qtach	VOL50Q	D+305
644K Highvis Qtach	VOL50Q	D+305
710G Ind Qtach	JRB416	D+549
710J Ind Qtach	JRB416	D+549
710K Ind Qtach	JRB416	D+549
710L Ind Qtach	JRB416	D+549

Direct To Loader Boom Mounts		
48 Ind Direct	JD48IND	C

Loader Order Mounting Codes

TL110 Ind Direct	JDTL110	B
210C Ind Direct (Serial# 742527 - End)	JD310C	D
210K Ind Direct	JD310SG	D
210K EP Ind Direct	JD310SG	D
210L Ind Direct	JD310SG	D
210LE Ind Direct	JD310SG	D
210LJ Ind Direct	JD310SG	D
210L EP Ind Direct	JD310SG	D
244E Ind Direct	JD244E	D
244H Ind Direct	JD244E	D
300 Ind Direct	JD300	C
300D Ind Direct	JD310C	D
310C Ind Direct	JD310C	D
310D Ind Direct	JD310C	D
310E Direct (Serial# 0 - 881677)	JD310E	D
310E Direct (Serial# 881678 - End)	JD310SG	D
310SE Direct (Serial# 0 - 881677)	JD310E	D
310SE Direct (Serial# 881678 - End)	JD310SG	D
310G Direct	JD310SG	D
310SG Direct	JD310SG	D
310J Direct	JD310SG	D
310SJ Direct	JD310SG	D
310SJ TC Direct	JD310SG	D
310K Direct	JD310SG	D
310SK Direct	JD310SG	D
310K EP Direct	JD310SG	D
310L Direct	JD310SG	D
310SL Direct	JD310SG	D
310SL HL Direct	JD310SG	D
310L EP Direct	JD310SG	D
315C Ind Direct	JD310C	D
315D Ind Direct	JD310C	D
315SE Direct (Serial# 0 - 881677)	JD310E	D
315SE Direct (Serial# 881678 - End)	JD310SG	D
315SG Direct	JD310SG	D
315SJ Direct	JD310SG	D
344E Ind Direct	JD344E	D
344G Ind Direct	JD344G	D
344H Ind Direct	JD344J	D+305
344J Ind Direct	JD344J	D+305
344K Ind Direct	JD344J	D+305
401C Direct	JD401C	D
410C Ind Direct	JD310C	D
410D Ind Direct	JD310C	D
410E Direct (Serial# 0 - 881677)	JD310E	D
410E Direct (Serial# 881678 - End)	JD310SG	D
410G Direct	JD310SG	D
410J Direct	JD310SG	D
410K Direct	JD310SG	D
410L Direct	JD310SG	D
444E Ind Direct	JD444E	D
444G Ind Direct	JD444G	D
444H Z-BAR Direct	JD444H	D
444J POWERLLEL Direct	JD444JP	D
444J Z-BAR Direct	JD444H	D
444K Direct	JD444H	D
444K POWERLLEL Direct	JD444JP	D
510 Ind Direct	JD510	D
510C Ind Direct	JD310C	D
510D Ind Direct	JD310C	D
544A Ind Direct	JD544A	D+305
544E Ind Direct	JD544E	D+305
544G Ind Direct	JD544G	D+305

544H Ind Direct	JD544J	D+305
544J Ind Direct	JD544J	D+305
610C Ind Direct	JD310C	D
624E Ind Direct	JD624E	D+549
624G Ind Direct	JD624G	D+549
644B Ind Direct	JD644B	D+549
644G Ind Direct	JD644G	D+549
644H Ind Direct	JD644H	D+549
710G Ind Direct	JD710G	D+549
710J Ind Direct	JD710G	D+549
710K Ind Direct	JD710G	D+549
710L Ind Direct	JD710G	D+549
724J Ind Direct	JD724J	D+549
7310 Ind Direct	JD7310	D+305

JRB	Part #	Price Code
JRB Deere E Series Qtach	JRBE	D+305
JRB WB140 Series Qtach	JRBWB140	D+549
JRB 416 Series Qtach	JRB416	D+549
JRB 418 Series Qtach	JRB418	D+549
JRB 420 Series Qtach	JRB420	D+671

Kawasaki	Part #	Price Code
Quick Attach Mounts		
45ZV Qtach	KA45ZVQ	D+305
45ZV-2 Qtach	KA45ZVQ	D+305
Direct To Loader Boom Mounts		
45ZV Direct	KA45ZVD	D
80ZV Direct	KA80ZVD	D

Kioti	Part #	Price Code
Quick Attach Mounts		
Kioti CK10 Series Front Hitch	KICK10FH	C
KL901 (Skidsteer Carrier) Qtach	BO500	A
KL1153 (Skidsteer Carrier) Qtach	BO500	A
KL2510 (Skidsteer Carrier) Qtach	BO500	A
KL2610 (Skidsteer Carrier) Qtach	BO500	A
KL4010 (Skidsteer Carrier) Qtach	BO500	A
KL4020 (Skidsteer Carrier) Qtach	BO500	A
KL5510 (Skidsteer Carrier) Qtach	BO500	A
KL6010 (Skidsteer Carrier) Qtach	BO500	A
KL7320 (Skidsteer Carrier) Qtach	BO500	A
1590 Qtach	BO500	A

Direct To Loader Boom Mounts		
102 Direct	KI102	B
KL120 Direct	KIKL120	B
KL130 Direct	KIKL130	B
KL351 Direct	KIKL401	B
KL401 Direct	KIKL401	B
KL402 Direct	KIKL401	B
KL451 Direct	KIKL451	B
KL901 Direct	KIKL901	B
1210 Direct	KI1210D	B
1730 Direct	KI1730	B
SL2410 Direct	KISL2410	B
KL2510 Direct	KIKL2510	B
KL7320 Direct	KIKL7320	B

KMW	Part #	Price Code
65 Direct	KM65	C
K76 Direct	KM130	B
K78 Direct	KM130	B

Loader Order Mounting Codes

K88 Direct	KM130	B
130 Direct	KM130	B
132 Direct	KM132	B
145 Direct	KM130	B
345 Direct	KM130	B
350 Direct	KM350	B
400 Direct	KM400	B
K500 Direct	KM130	B
520 Direct	KM130	B
600 Direct	KM600	B
K760 Direct	KM130	B
775 Direct	KM775	B

Komatsu	Part #	Price Code
Quick Attach Mounts		
WA65 Qtach	KSWA80	D+305
WA80 Qtach	KSWA80	D+305
WA100 Qtach	KSWA100	D+305
Direct To Loader Boom Mounts		
WA50-3 Direct	KSWA503	D
WB140-2 Direct	KSWB140	D
WB146 Direct	KSWB140	D
WB150-2 Direct	KSWB140	D
WB156 Direct	KSWB140	D
WA180-3 Direct	KSWA1803	D
WA250-6 Direct	KSWA2506	D
WA320-5 Direct	KSWA3205	D
WA320-6 Direct	KSWA3205	D

Koyker	Part #	Price Code
Quick Attach Mounts		
140 Skidsteer Qtach	BO500	A
145 Skidsteer Qtach	BO500	A
155 Skidsteer Qtach	BO500	A
180 Skidsteer Qtach	BO500	A
185 Skidsteer Qtach	BO500	A
Direct To Loader Boom Mounts		
160 Direct	KKR160	B

Kubota	Part #	Price Code
Quick Attach Mounts		
BX Series Front Hitch Qtach	KUBX	B
BX2810 Series Front Hitch Qtach	KUBX2810	D+305
B26TLB Skidsteer Qtach	BO500	A
L Series Front Hitch Qtach	KUL30	B
L4455 Front Hitch Qtach	KUL4455	C
L4455A Front Hitch Qtach	KUL4455	C
L39 Skidsteer Qtach	BO500	A
M59TLB Skidsteer Qtach	BO500	A
LA240A (Pin style Qtach)	KULA240	B
LA243A (Pin style Qtach)	KULA240	B
M310 Euro Qtach	AO600	A
R310 Qtach	KU310Q	C
M340 Euro Qtach	AO600	A
LA340 Skidsteer Qtach	BO500	A
LA340S Skidsteer Qtach	BO500	A
LA344 Skidsteer Qtach	BO500	A
LA344S Skidsteer Qtach	BO500	A
LA364 Qtach (pin style)	KULA304	B
LA403 Qtach (pin style)	KULA403	B
R410 Qtach	KU410	C

M415 Euro Qtach	AO600	A
R420 Qtach	KU410	C
LA435 Swift-Tach Skidsteer Qtach	SSLQ6	A
LA504 Qtach (pin style)	KULA504	B
LA525 Skidsteer Qtach	BO500	A
LA526 Skidsteer Qtach	BO500	A
R510 Qtach	KU410	C
R520 Qtach	KU410	C
R530 Euro Qtach	KUR630	D+305
R530 Skidsteer Qtach	BO500	A
LA535 Swift-Tach Skidsteer Qtach	SSLQ6	A
M540 (old style) Qtach	AO500	B
M540 Euro Qtach	AO600	A
LA545 Swift-Tach Skidsteer Qtach	SSLQ6	A
M560 Qtach	AO500	B
R630 Euro Qtach	KUR630	D+305
R630 Skidsteer Qtach	BO500	A
R640 Euro Qtach	KUR630	D+305
R640 Skidsteer Qtach	BO500	A
M720 Euro Qtach	AO600	A
LA724 Skidsteer Qtach	BO500	A
LA765 Skidsteer Qtach	BO500	A
LA805 Skidsteer Qtach	BO500	A
LA852 Qtach	KULA852	B
M940 Euro Qtach	AO600	A
M1000 Qtach	CI510Q	B
M1250 Qtach	CI510Q	B
M1275 Qtach	CI510Q	B
M1410 Qtach	CI510Q	B
TL1000 Skidsteer Qtach	BO500	A
1001 Qtach (pin style)	KU1001	B
1001 Qtach (hook style)	KU1001Q	B
1002 Qtach (pin style)	KU1001	B
1002 Qtach (hook style)	KU1001Q	B
LA1055 Skidsteer Qtach	BO500	A
LA1065 Skidsteer Qtach	BO500	A
TL1150 Skidsteer Qtach	BO500	A
LA1153 Euro Qtach	AO600	A
LA1153 Skidsteer Qtach	BO500	A
LA1154 Skidsteer Qtach	BO500	A
LA1251 Kubota Qtach	KU1251Q	B
LA1301 Kubota Qtach	KU1251Q	B
LA1353 Euro Qtach	AO600	A
LA1353 Skidsteer Qtach	BO500	A
M1423 Euro Qtach	AO600	A
LA1601 Euro Qtach	AO600	A
LA1601 Kubota Qtach	KU1251Q	B
LA1601 Skidsteer Qtach	BO500	A
TL1709 Skidsteer Qtach	BO500	A
LA1854 Skidsteer Qtach	BO500	A
LA1854E Euro Qtach	AO600	A
LA1955 Skidsteer Qtach	BO500	A
LA2253 Euro Qtach	AO600	A
LA2253 Skidsteer Qtach	BO500	A
LA2255 Skidsteer Qtach	BO500	A
LA2254 Euro Qtach	AO600	A
LA2254 Skidsteer Qtach	BO500	A
LA2255E Euro Qtach	AO600	A
LM2605 Euro Qtach	AO600	A
Direct To Loader Boom Mounts		
B20 Direct	KU421A	B
Q20 DM Direct	AOQ55DM	B

Loader Order Mounting Codes

22 Direct	KU22	B
Q30 DM Direct	AOQ55DM	B
L35 Direct	KUL35	B
Q35 DM Direct	AOQ55DM	B
M21 Direct	AOQ55DM	B
M26 Direct	AOQ55DM	B
M31 Direct	AOQ55DM	B
M32 Direct	AOQ55DM	B
M36 Direct	AOQ55DM	B
M37 Direct	AOQ55DM	B
M41 Direct	AOQ55DM	B
M42 Direct	AOQ55DM	B
M45 DM Direct	AOQ55DM	B
M46 Direct	AOQ55DM	B
M47 Direct	AOQ55DM	B
M50 DM Direct	AOQ55DM	B
M51 Direct	AOQ55DM	B
M52 Direct	AOQ55DM	B
M55 DM Direct	AOQ55DM	B
M56 Direct	AOQ55DM	B
M57 Direct	AOQ55DM	B
LA203 Direct	KULA240	B
LA210 Direct	KULA210	C
LA211 Direct	KULA210	C
LA240 Direct	KULA240	B
LA240A Direct	KULA240	B
LA243 Direct	KULA240	B
LA243A Direct	KULA240	B
300 Direct	KU300	B
300A Direct	KU300	B
BF300 Direct	KU300	B
LA300B Direct	KULA300B	B
LA301 Direct	KU301	B
LA302 Direct	KU301	B
LA304 Direct	KULA304	B
R310 Direct	KU310	C
LA340 Direct	KULA240	B
LA340S Direct	KULA240	B
LA344 Direct	KULA240	B
LA344S Direct	KULA240	B
BF350 Direct	KU350A	B
LA350 Direct	KU350	B
LA350A Direct	KULA350A	B
L352 Direct	KUL352	B
LA364 Direct	KULA304	B
BF400 Direct	KULA450	B
LA400 Direct	KU400	B
LA401 Direct	KULA480	B
LA402 Direct	KULA480	B
LA403 Direct	KULA403	B
R400 Direct	KUR400	C
R410 Direct	KU420	C
R420 Direct	KU420	C
TL420 Direct	KU421A	B
TL421A Direct	KU421A	B
LA434 Direct	KULA504	B
LA450 Direct	KULA450	B
LA452S Direct	KULA480	B
LA463 Direct	KULA463	B
LA480 Direct	KULA480	B
LA481 Direct	KULA480	B
LA482 Direct	KULA480	B

490 Direct	KU490	B
K490 Direct	KUK490	B
BF500 Direct	KULA450	B
LA504 Direct	KULA504	B
LA513 Direct	KULA463	B
LA514 Direct	KULA525	B
R520 Direct	KUR520	C
LA524 Direct	KULA525	B
LA524FL Direct	KULA525	B
LA525 Direct	KULA525	B
LA525FL Direct	KULA525	B
LA526 Direct	KULA525	B
LA534 Direct	KULA504	B
530 Direct	KM132	B
R530 Direct	KUR630D	D+305
M540 Direct	AO660	B
LA555 Direct	KULA525	B
R630 Direct	KUR630D	D+305
R640 Direct	KUR640D	D+305
LA650 Direct	KULA650	B
LA680 Direct	KULA650	B
LA681 Direct	KULA650	B
LA682 Direct	KULA480	B
LB702 Direct	KULA480	B
LA703 Direct	KULA703	B
TL720 Direct	KUL35	B
LA723 Direct	KULA723	B
LA724 Direct	KULA724	B
760 Direct	AO660	B
LA765 Direct	KULA765	B
790 Direct	KM132	B
795 Direct	KM132	B
796 Direct	KM132	B
BF800 Direct	KU800	B
LA805 Direct	KULA724	B
LA844 Direct	KULA724	B
850 Direct	KU850	B
LA852 Direct	KULA852	B
LA852-1 Direct	KULA852	B
LA853 Direct	KULA853	B
LA854 Direct	KULA724	B
890 Direct	KU890	B
900 Direct	KU900	B
BF900 Direct	KU900	B
LA950 Direct	KULA950	B
M1000 Direct	KUM1000	B
1001 Direct	KU1001	B
1002 Direct	KU1001	B
LA1055 Direct	KULA724	B
TL1150 Direct	KUTL1150	B
LA1153 Direct	KULA1153	B
LA1153E Direct	KULA1153	B
LA1154E Direct	KULA1153	B
LA1251 Direct	KU1251	B
TL1350 Direct	KUTL1350	B
LA1353EA Direct	KULA1153	B
LA1353E Direct	KULA1153	B
LA1403E Direct	KULA1153	B
M1410 Direct	CI510	B
LA1640A Direct	KU1640A	B
L1720 Direct	KUL1720	B
1810 Direct	KU1810	B

Loader Order Mounting Codes

LA1854E Direct	KULA1153	B
LA1953E Direct	KULA1153	B
LA1954E Direct	KULA1153	B
LA1955E Direct	KULA1153	B
LA2254 Direct	KULA2254	B
LA2254E Direct	KULA2254	B
LA2255 Direct	KULA2254	B
LA2255E Direct	KULA2254	B
LM2605 Direct	KULM2605	D
M7500DT Direct	KU1810	B

Leon	Part #	Price Code
Quick Attach Mounts		
700 Qtach	LE700Q	B
800 Qtach	LE700Q	B

Direct To Loader Boom Mounts		
600 Direct	LE600	B
636 Direct	LE690	B
650 Direct	LE650	B
690 Direct	LE690	B
695 Direct	LE695	B
707 Direct	LE707	B

Liebherr	Part #	Price Code
L506 Qtach	JD244J	D+305

Long	Part #	Price Code
5140M Direct	LG5140M	B

LS (Leading Solutions)	Part #	Price Code
Quick Attach Mounts		
LL1101 LS Style Qtach	LSLL1101Q	B
LL1102 Skidsteer Style Qtach	BO500	A
LL2102 Skidsteer Style Qtach	BO500	A
LL3106 Skidsteer Style Qtach	BO500	A
LL3110 Skidsteer Style Qtach	BO500	A
LL3112 Skidsteer Style Qtach	BO500	A
LL4104 Skidsteer Style Qtach	BO500	A
LL5102 Skidsteer Style Qtach	BO500	A
LL5106 Skidsteer Style Qtach	BO500	A
LL6200 Skidsteer Style Qtach	BO500	A
LL8100 Skidsteer Style Qtach	BO500	A

Direct To Loader Boom Mounts		
LL1101 Direct	LSLL1101D	B
LL2100 Direct	KIKL120	B
LL5102 Direct	LSLL5102	B
LL6100 Direct	LSLL5102	B
LL7100 Direct	LSLL7100	B

Mahindra	Part #	Price Code
Quick Attach Mounts		
Max 26L Skidsteer Qtach	BO500	A
75PL Skidsteer Qtach	BO500	A
105SL Skidsteer Qtach	BO500	A
115 Skidsteer Qtach	BO500	A
116 Skidsteer Qtach	BO500	A
120 Skidsteer Qtach	BO500	A
1526L Skidsteer Qtach	BO500	A
2538L Skidsteer Qtach	BO500	A
2555L Skidsteer Qtach	BO500	A
2555CL Skidsteer Qtach	BO500	A

3550L Skidsteer Qtach	BO500	A
4550 4L Skidsteer Qtach	BO500	A
4565 2L Skidsteer Qtach	BO500	A
5545 4L Skidsteer Qtach	BO500	A
5565 2L Skidsteer Qtach	BO500	A
5565 4L Skidsteer Qtach	BO500	A

Direct To Loader Boom Mounts		
23L Direct	MH23L	B
max 24 Direct	MHMAX24	B
emax 25L Direct (single cylinder)	MHEM25L	B
emax 25L Direct (double cylinder)	MHEM25LS	B
emax 25L-S Direct	MHEM25LS	B
ML102 Direct	MHML102	B
ML105 Direct	MHML102	B
ML105 Self Levelling Direct	MHML105SL	B
ML106 Direct	MHML106	B
ML110 Direct	MHML106	B
ML115 Direct	MHML115	B
ML120 Direct	MHML120	B
ML130 Direct	MHML130	B
ML202 Direct	MHML202	B
ML205 Direct	MHML205	B
4550 Direct	MH4550	B
6075L Direct	MH6075L	B
9125CL Direct	MH9125CL	B

Manitou	Part #	Price Code
Quick Attach Mounts		
Manitou Qtach	MAQT	D
MT420 Qtach	MA523Q	D
MLT523 Qtach	MA523Q	D
MLAT533 Qtach	MA523Q	D
MLT625 Qtach	MA523Q	D
MLT840 Qtach	MAQT	D
MLT960 Qtach	MA960Q	D
MLT961 Qtach	MA960Q	D
MT 5519 Qtach	GEDY519	C

Direct To Loader Boom Mounts		
MLT523 Direct	MA523D	D+305
MLA T516 75H Direct	MAMLAT51675	D+549
MLA T533 Direct	MAMLA533D	D+549
MLT625 Direct	MA625D	D+305
MLT630 Direct	MA630D	D+305
MLT732 Direct	MA732D	D+305

Massey Ferguson (Ag)	Part #	Price Code
Quick Attach Mounts		
L105E Skidsteer Qtach	BO500	A
DL125 Skidsteer Qtach	BO500	A
DL130 Pin Style Qtach	MFDL260	B
DL130 Skidsteer Qtach	BO500	A
DL135 Skidsteer Qtach	BO500	A
L135E Skidsteer Qtach	BO500	A
L210 Pin Style Qtach	MFDL260	B
L210 Skidsteer Qtach	BO500	A
236 Qtach	MF236	B
DL250 Pin Style Qtach	MFDL260	B
DL250 Skidsteer Qtach	BO500	A
DL260 Pin Style Qtach	MFDL260	B
DL260 Skidsteer Qtach	BO500	A
DL280 Hook Type Qtach	FNAO600	A

Loader Order Mounting Codes

836 Qtach	MF236	B
911X Euro Qtach	AO600	A
911X Skidsteer Qtach	BO500	A
916X Euro Qtach	AO600	A
916X Skidsteer Qtach	BO500	A
921X Euro Qtach	AO600	A
921X Skidsteer Qtach	BO500	A
926X Euro Qtach	AO600	A
926X Skidsteer Qtach	BO500	A
930 Qtach	AO600	A
931X Euro Qtach	AO600	A
931X Skidsteer Qtach	BO500	A
935 Qtach	AO600	A
936X Skidsteer Qtach	BO500	A
946X Euro Qtach	AO600	A
940 Qtach	AO600	A
945 Qtach	AO600	A
950 Qtach	AO600	A
955 Qtach	AO600	A
965 Qtach	AO600	A
975 Qtach	AO600	A
985 Qtach	AO600	A
1036 Pin Style Qtach	MF1038	B
1038 Pin Style Qtach	MF1038	B
1040 Pin Style Qtach	MF1040	B
1040 Hook Type Qtach	FNAO600	A
1050 Qtach	FNAO600	A
1055 Hook Type Qtach	FNAO600	A
1055 Skidsteer Qtach	BO500	A
1060 Qtach	FNAO600	A
1065 Qtach	FNAO600	A
1070 Qtach	FNAO600	A
1080 Qtach	FNAO600	A
1090 Qtach	MF1090	B
1525 Qtach (pin style)	MF1525	B
1530 Qtach (universal Qtach)	BO500	A
1532 Qtach (universal Qtach)	BO500	A
FL1805 Skidsteer Qtach	BO500	A

Direct To Loader Boom Mounts

SL44 Direct	MF1464	B
L80 Direct	MF1464	B
L90 Direct	MF1464	B
DL95 Direct	AO100C	B
L100 Direct	MF1466	B
L100E Direct	AO100C	B
DL100 Direct	MF2350	B
L105E Direct	MFL105E	B
DL120 Direct	AGSL46A	B
DL125 Direct	MFDL125	B
DL130 Direct	MFDL260	B
DL135 Direct	MFDL125	B
L135E Direct	MFL105E	B
L200 Direct	MFDL260	B
L210 Direct	MFDL260	B
232 Direct	MF1040	B
235 Direct	MF235	B
236 Direct	MF236	B
246 Direct	MF246	B
DL250 Direct	MFDL260	B
256 Direct	MF256	B
DL260 Direct	MFDL260	B

DL280 Direct	MFDL280	B
300 Direct	MF300	B
836 Direct	MF236	B
848 Direct	MF246	B
884 Direct	MF884	B
911X Direct	AOX36	B
916X Direct	AOX36	B
920 Direct	AOQ55DM	B
921 Direct	AOQ55DM	B
921X Direct	AOX36	B
925 Direct	AOQ55DM	B
926 Direct	AOQ55DM	B
926X Direct	AOX36	B
930 Direct	AOQ55DM	B
931 Direct	AOQ55DM	B
931X Direct	AOX36	B
933 Direct	AOQ55DM	B
935 Direct	AOQ55DM	B
936 Direct	AOQ55DM	B
936X Direct	AOX36	B
938 Direct (2000-older)	MF938	B
938 Direct (2005-newer)	AOQ55DM	B
940 Direct	AOQ55DM	B
941X Direct	AOX36	B
941 Direct	AOQ55DM	B
945 Direct	AOQ55DM	B
946 Direct	AOQ55DM	B
946X Direct	AOX36	B
948 Direct (2000-older)	MF938	B
948 Direct (2005-newer)	AOQ55DM	B
949 Direct	AOQ55DM	B
950 Direct	AOQ55DM	B
951 Direct	AOQ55DM	B
951X Direct	AOX36	B
955 Direct	AOQ55DM	B
956 Direct (2005-newer)	AOQ55DM	B
956X Direct	AOX36	B
958 Direct	AOQ55DM	B
960 Direct	AOQ55DM	B
961 Direct	AOQ55DM	B
965 Direct	AOQ55DM	B
966 Direct	AOQ55DM	B
968 Direct	AOQ55DM	B
975 Direct	AOQ55DM	B
976 Direct	AOQ55DM	B
978 Direct	AOQ55DM	B
985 Direct	AOQ55DM	B
985X Direct	AOQ55DM	B
988 Direct	AOQ85	B
1016 Direct	MF1016	B
1032 Direct	MF1040	B
1040 Direct	MF1040	B
1048 Direct	MF1038	B
1050 Direct	MF1040	B
1055 Direct	MFDL260	B
1060 Direct	MF1038	B
1070 Direct	MFDL280	B
1080 Direct	MFDL280	B
1244 Direct	MF1464	B
1246 Direct	MF1466	B
1464 Direct	MF1464	B
1466 Direct	MF1466	B

Loader Order Mounting Codes

1515 Direct	MF1464	B
1520 Direct	MF1464	B
1525 Direct	MF1525	B
1530 Direct	MFDL260	B
FL 1805 Direct	MFFLX2106	B
FLX 2106 Direct	MFFLX2106	B
2350 Direct	MF2350	B
FLX 2407 Direct	MFFLX2407	B
FL2611 Direct	MFDL125	B
FL2814 Direct	MFDL125	B
FL3522 Direct	AOQ55DM	B
FL3723 Direct	AOQ55DM	B
FL4125 Direct	AOQ55DM	B
FL4227 Direct	AOQ55DM	B
FL3615 Direct	AOQ55DM	B
FL3819 Direct	AOQ55DM	B
FL4121 Direct	AOQ55DM	B
FL4124 Direct	AOQ55DM	B
FL4327 Direct	AOQ55DM	B
FL4628 Direct	AOQ55DM	B
FL5033 Direct	AOQ55DM	B

Massey Ferguson (Industrial)	Part #	Price Code
30 Ind Direct	MF30	B
30B Ind Direct	MF30B	B
32 Ind Direct	MF32	B
32A Ind Direct	MF32A	B
34 Ind Direct	MF34	B
34A Ind Direct	MF34A	B
35A Ind Direct	MF35A	B
40 Direct	MF40	B
40 Ind Direct	MF40IND	B
40B Direct	MF40B	B
40E Direct	MF40E	B
50A Direct	MF50A	B
50C Ind Direct	MF50C	B
50E Ind Direct	MF50E	D
50EX Ind Direct	MF50E	D
50HX Ind Direct	MF50E	D
60 Ind Direct	MF60	B
99 Direct	MF100	C
100 Ind Direct	MF100	C
102 Ind Direct	MF102	B
200 Ind Direct	MF200	B
203 Ind Direct	MF102	B
640 Ind & Ferrec Direct	MF50E	D
650 Ind & Ferrec Direct	MF50E	D
660 Ind & Ferrec Direct	MF50E	D
740 Ind & Ferrec Direct	MF50E	D
2200 Ind Direct	MF2200	B

McCormick	Part #	Price Code
Quick Attach Mounts		
L435 Euro Qtach	AO600	A
L451 Euro Qtach	AO600	A
L468 Euro Qtach	AO600	A
Direct To Loader Boom Mounts		
125C Direct	MC125C	B
130C Direct	MC130C	B
L140 Direct	AOQ55DM	B
L451 Direct	AOQ55DM	B
L435 Direct	AOQ55DM	B

L456 Direct	AOQ55DM	B
L468 Direct	AOQ55DM	B

Mels	Part #	Price Code
Qtach	MEQT	B

Merlo	Part #	Price Code
Quick Attach Mounts		
ZM2 Qtach	MERZM2	D+549
ZM3 Qtach	MERZM3	D+549
ZM2&3 Qtach	MERZM23	D+549
Direct To Loader Boom Mounts		
P25.6 Direct	MERP256	D

New Holland (Ag)	Part #	Price Code
Quick Attach Mounts		
16LA Qtach	BO500	A
17LA Qtach	BO500	A
18LA Qtach	BO500	A
32LA Qtach	BO500	A
33LA Qtach	BO500	A
46LB Qtach	BO500	A
LW50 Qtach	NHLW50Q	D+549
LW50.B Qtach	NHLW50Q	D+549
LW50.B TC Skidsteer Qtach	BO500	A
52LA Qtach	BO500	A
52LB Qtach	BO500	A
52LC Qtach	BO500	A
56LB Qtach	AO600	A
62LB Qtach	AO600	A
72LA Qtach	FO7411Q	C
72LB Qtach	AO600	A
82LB Qtach	NH7614	C
84LB Qtach	NH7614	C
140TL Skidsteer Qtach	BO500	A
240TL Skidsteer Qtach	BO500	A
250TL Skidsteer Qtach	BO500	A
260TL Skidsteer Qtach	BO500	A
270TL Skidsteer Qtach	BO500	A
611TL Skidsteer Qtach	BO500	A
625TL Skidsteer Qtach	BO500	A
LM410 Qtach (Old style New Holland)	NHLM410Q	D
LM415A Qtach (JCB Qfit style)	JC530B	D
LM415A Qtach (Manitou Style)	MAQT	D
LM415A Qtach (Old style New Holland)	NHLM410Q	D
LM430 Qtach (JCB Qfit style)	JC530B	D
LM435A Qtach (JCB Qfit style)	JC530B	D
LM435A Qtach (Manitou Style)	MAQT	D
LM435A Qtach (Old style New Holland)	NHLM410Q	D
LM445A Qtach (JCB Qfit style)	JC530B	D
LM445A Qtach (Manitou Style)	MAQT	D
LM445A Qtach (Old style New Holland)	NHLM410Q	D
LM640 Qtach (JCB Qfit style)	JC530B	D
LM5.25 Qtach (Skidsteer Qtach)	BO500	A
LM5.25 Qtach (Manitou Style)	MAQT	D
LM5.25 Qtach (Old style New Holland)	NHLM410Q	D
LM6.28 Qtach (Manitou Style)	MAQT	D
LM6.28 Qtach (Old style New Holland)	NHLM410Q	D
LM6.32 Qtach (JCB Qfit style)	JC530B	D
LM6.32 Qtach (Manitou Style)	MAQT	D
LM6.32 Qtach (Old style New Holland)	NHLM410Q	D
LM6.35 Qtach (JCB Qfit style)	JC530B	D

Loader Order Mounting Codes

LM6.35 Qtach (Manitou Style)	MAQT	D
LM6.35 Qtach (Old style New Holland)	NHLM410Q	D
LM7.35 Qtach (JCB Qfit style)	JC530B	D
LM7.35 Qtach (Manitou Style)	MAQT	D
LM7.35 Qtach (Old style New Holland)	NHLM410Q	D
LM7.42 Qtach (JCB Qfit style)	JC530B	D
LM7.42 Qtach (Manitou Style)	MAQT	D
LM7.42 Qtach (Old style New Holland)	NHLM410Q	D
TH7.42 Qtach (Manitou Style)	MAQT	D
TH7.42 Qtach (Old style New Holland)	NHLM410Q	D
TH7.42 Qtach (JCB Qfit style)	JC530B	D
LM9.35 Qtach (JCB Qfit style)	JC530B	D
LM9.35 Qtach (Manitou Style)	MAQT	D
LM9.35 Qtach (Old style New Holland)	NHLM410Q	D
TH9.35 Qtach (JCB Qfit style)	JC530B	D
TH9.35 Qtach (Manitou Style)	MAQT	D
TH9.35 Qtach (Old style New Holland)	NHLM410Q	D
800TL Series Qtach	AO600	A
LM840 Qtach (JCB Qfit style)	JC530B	D
LM850 Qtach (JCB Qfit style)	JC530B	D
LM860 Qtach (JCB Qfit style)	JC530B	D
LM5020 Qtach (Skidsteer Qtach)	BO500	A
LM5020 Qtach (Manitou Style)	MAQT	D
LM5020 Qtach (Old style New Holland)	NHLM410Q	D
LM5030 Qtach (Manitou Style)	MAQT	D
LM5030 Qtach (Old style New Holland)	NHLM410Q	D
LM5040 Qtach (Manitou style)	MAQT	D
LM5040 Qtach (Old style New Holland)	NHLM410Q	D
LM5060 Qtach (Manitou style)	MAQT	D
LM5060 Qtach (Old style New Holland)	NHLM410Q	D
LM5080 Qtach (Manitou style)	MAQT	D
LM5080 Qtach (Old style New Holland)	NHLM410Q	D
7614 Qtach	NH7614	C

Direct To Loader Boom Mounts

10LA Direct	NH10LA	B
12LA Direct	NH12LA	B
14LA Direct	NH14LA	B
15LA Direct	NH14LA	B
16LA Direct	NH17LA	B
17LA Direct	NH17LA	B
18LA Direct	NH17LA	B
32LA SL Direct	NH32LA	B
32LA NSL Direct	NH32LANSL	B
32LC Direct	NH32LC	B
33LA SL Direct	NH32LA	B
33LA NSL Direct	NH32LANSL	B
52LA SL Direct	NH52LA	B
52LA NSL Direct	NH32LANSL	B
52LB Direct	CILX132	B
52LC Direct	NH32LC	B
56LB Direct	CILX162	B
62LB Direct	CILX162	B
72LA Direct	NH72LA	B
72LB Direct	CILX162	B
84LB Direct	NH7614D	C
100LC Direct	NH100LC	B
100TL Direct	FO7308	B
110TL Direct	FO7308	B
140TL Direct	NH240TL	B
210TL Direct	NH10LA	B
240TL Direct	NH240TL	B
235TL Direct	AO100C	B

250TL Direct	NH250TL	B
260TL Direct	NH250TL	B
270TL Direct	NH250TL	B
550LU Direct	NH555LU	B
555LU Direct	NH555LU	B
615TL Direct	CIL540	B
616TL Direct	AOX36	B
620TL Direct	FO7310	B
621TL Direct	NH621TL	B
622TL Direct	AOX36	B
625TL Direct	CIL540	B
626TL Direct	AOX36	B
627TL Direct	AOX36	B
632TL Direct	AOX36	B
637TL Direct	AOX36	B
655TL Direct	CIL620	B
665TL Direct	CIL620	B
810TL Direct	AOQ55DM	B
815TL Direct	AOQ55DM	B
820TL Direct	AOQ55DM	B
825TL Direct	AOQ55DM	B
830TL Direct	AOQ55DM	B
835TL Direct	AOQ55DM	B
840TL Direct	AOQ55DM	B
845TL Direct	AOQ55DM	B
850TL Direct	AOQ55DM	B
855TL Direct	AOQ55DM	B
860TL Direct	AOQ55DM	B
LM5020 Direct	NHLM5020	D+305
LM6.28 Direct	NHLM628	D+305
LM6.32 Direct	NHLM632	D+549
7614 Direct	NH7614D	C

New Holland (Industrial)

	Part #	Price Code
Quick Attach Mounts		
LW50 Qtach	NHLW50Q	D+549
LW50.B Qtach	NHLW50Q	D+549
LW50.B TC Skidsteer Qtach	BO500	A
W70C Hook Style Qtach	NHW80CQ	D+305
W70C Skidsteer Style Qtach	BO500	A
LW80.B TC Skidsteer Qtach	BO500	A
LW80.B Hook Style Qtach	NHLW80	D+549
W80C Hook Style Qtach	NHW80CQ	D+305
W80C Skidsteer Style Qtach	BO500	A
U80 FFC Qtach	CAFFC	D+305
U80B FFC Qtach	CAFFC	D+305
B90B FFC Qtach	CAFFC	D+305
LB90.B FFC Qtach	CAFFC	D+305
LW90 JRB Qtach	JRB416	D+549
B95 FFC Qtach	CAFFC	D+305
B95BTC FFC Qtach	CAFFC	D+305
B95BLR FFC Qtach	CAFFC	D+305
B95LR FFC Qtach	CAFFC	D+305
B110 FFC Qtach	CAFFC	D+305
B110B FFC Qtach	CAFFC	D+305
LB110.B FFC Qtach	CAFFC	D+305
LW110 JRB Qtach	JRB416	D+549
LW110.B JRB Qtach	JRB416	D+549
W110 JRB Qtach	JRB416	D+549
LW110.B TC JRB Qtach	JRB416	D+549
W110 TC JRB Qtach	JRB416	D+549
LW130 JRB Qtach	JRB416	D+549

Loader Order Mounting Codes

LW130 TC JRB Qtach	JRB416	D+549
LW130.B JRB Qtach	JRB416	D+549
W130 JRB Qtach	JRB416	D+549
LW130.B TC JRB Qtach	JRB416	D+549
W130 TC JRB Qtach	JRB416	D+549
LW170 JRB Qtach	JRB416	D+549
LW170 TC JRB Qtach	JRB416	D+549
LW170.B JRB Qtach	JRB416	D+549
W170B JRB Qtach	JRB416	D+549
LW170.B TC JRB Qtach	JRB416	D+549
W170B TC JRB Qtach	JRB416	D+549
LW190 JRB Qtach	JRB418	D+549
LW190.B JRB Qtach	JRB418	D+549
W190B JRB Qtach	JRB418	D+549

Direct To Loader Boom Mounts

W50C Direct up to May 30/18	NHW80C	D+549
W50C Direct May 30/18 to current	CA321F	D+549
W60C Direct up to May 30/18	NHW80C	D+549
W60C Direct May 30/18 to current	CA321F	D+549
W70C Direct up to May 30/18	NHW80C	D+549
W70C Direct May 30/18 to current	CA321F	D+549
LB75 Ind Direct	FO575E	D
LB75.B Direct	FO575E	D
LV80 Direct	CA580L	D
U80 Direct	CA580L	D
U80B Direct	CA580L	D
U80C Direct	CA580L	D
W80C Direct up to May 30/18	NHW80C	D+549
W80C Direct May 30/18 to current	CA321F	D+549
B90B Direct	FO575E	D
LB90 Ind Direct	FO575E	D
LB90.B Direct	FO575E	D
LW90 Direct	NHLW110	D+305
B95 Ind Direct	FO575E	D
B95B Direct	FO575E	D
B95TC Direct	NHB95TC	D
B95BTC Direct	FO575E	D
B95BLR Direct	FO575E	D
B95C Direct	FO575E	D
B95CLR Direct	FO575E	D
B95LR Direct	FO575E	D
LB95 Direct	FO575E	D
B110 Direct	FO575E	D
B110B Direct	FO575E	D
LB110.B Direct	FO575E	D
LB110 Ind Direct	FO575E	D
LW110 ZBAR Direct	NHLW110	D+305
LW110.B ZBAR Direct	NHW110B	D+305
W110 Direct	NHLW110	D+305
W110B ZBAR Direct	NHW110B	D+305
W110 TC Direct	CA521EXT	D+305
W110B TC Direct	CA521EXT	D+305
B115 Direct	NHB95TC	D
LB115 Ind Direct	NHLB115	D
LW130B TC Direct	CA621EXT	D+305
LW130B ZBAR Direct	CA621EZ	D+305
W130 ZBAR Direct	CA621EZ	D+305
W130B ZBAR Direct	CA621EZ	D+305
W130B TC Direct	CA621EXT	D+305
LB190 Ind Direct	FO575E	D
345D Ind Direct	FO345D	D

Pichon	Part #	Price Code
P126 Direct	PIP126	B

Reist	Part #	Price Code
Qtach	REQT	A

Schaeff	Part #	Price Code
821 Qtach	TX824	D+305
823 Qtach	TX824	D+305
824 Qtach	TX824	D+305
831 Qtach	TX824	D+305
832 Qtach	TX824	D+305
SKL833 Qtach	TX844	D+305
844 Qtach	TX844	D+305
853 Qtach	TX844	D+305

Schaffer	Part #	Price Code
Quick Attach Mounts		
930 Qtach	SC930	D+305
2000 Series Qtach	SC3000	D
3000 Series Qtach	SC3000	D
4000 Series Qtach	SC4000	D
9000 Series Qtach	SC4000	D
9380 Qtach	SC930	D+305
9660T Qtach	SC9660T	D+305

Direct To Loader Boom Mounts		
2027 Direct	SC3350D	D+305
2028 Direct	SC3350D	D+305
2345 Direct	SC3350D	D+305
3350 Direct	SC3350D	D+305
3550T Direct	SC3550T	C
4360 Direct	SC4360D	D+305
4250Z Direct	SC5058Z	D+305
5058Z Direct	SC5058Z	D+305
5650Z Direct	SC5058Z	D+305
5680Z Direct	SC5058Z	D+305

Schwartz	Part #	Price Code
Quick Attach Mounts		
1020X Qtach	FO7310	B
1040 Qtach	FO7310	B

Direct To Loader Boom Mounts		
920 Direct	FO7310	B
940 Direct	FO7109	B
1250 Direct	FO770	B
1300 Direct	FO772	B
1400 Direct	FO772	B

Sky Trak	Part #	Price Code
6036 Qtach	ST8042	D+305
6042 Qtach	ST8042	D+305
8042 Qtach	ST8042	D+305
10042 Qtach	ST8042	D+305
10054 Qtach	ST8042	D+305

Smythe	Part #	Price Code
Qtach	SMQT	A

Steiner	Part #	Price Code
Steiner	ST430	C

Loader Order Mounting Codes

Stoll	Part #	Price Code
Quick Attach Mounts		
FS10 Qtach	AO600	A
FZ10 Qtach	AO600	A
FS20 Qtach	AO600	A
FZ20 Qtach	AO600	A
F30 Qtach	AO600	A
FS30 Qtach	AO600	A
FZ30 Qtach	AO600	A
FS40 Qtach	AO600	A
FZ40 Qtach	AO600	A
FS50 Qtach	AO600	A
FZ50 Qtach	AO600	A
FS60 Qtach	AO600	A
FZ60 Qtach	AO600	A
FS80 Qtach	AO600	A
FZ80 Qtach	AO600	A
Direct To Loader Boom Mounts		
F4 Direct	STF30	B
F5 Direct	STF30	B
F8 Direct	STF30	B
FS8 Direct	STFZ10	B
FS8.1 Direct	STFZ10W	B
FZ8 Direct	STFZ10	B
FZ8.1 Direct	STFZ10W	B
F10 Direct	STF30	B
FS10 Direct	STFZ10	B
FZ10 Direct	STFZ10	B
FZ10.1 Direct	STFZ10W	B
F15 Direct	STF30	B
FS20 Direct	STFZ10	B
FZ20 Direct	STFZ10	B
FZ20.1 Direct	STFZ10W	B
FS30 Direct	STFZ30	B
FZ30 Direct	STFZ30	B
FZ30.1 Direct	STFZ50W	B
F30 Direct	STF30	B
FS40 Direct	STFZ30	B
FS40.1 Direct	STFZ50W	B
FZ40 Direct	STFZ30	B
FZ45 Direct	STFZ30	B
FZ45.1 Direct	STFZ50W	B
FS50 Direct	STFZ30	B
FZ50 Direct	STFZ30	B
FZ50.1 Direct	STFZ50W	B
FS60 Direct	STFZ30	B
FZ60 Direct	STFZ30	B
FZ60.1 Direct	STFZ50W	B
FZ80.1 Direct	STFZ50W	B
FC150 Direct	STFC450	B
FC250 Direct	STFC450	B
FC350 Direct	STFC450	B
FC450 Direct	STFC450	B
FC550 Direct	STFC450	B
FE650 Direct	STF30	B
FE750 Direct	STF30	B
FE850 Direct	STF30	B
Takeuchi	Part #	Price Code
Quick Attach Mounts		
TW65 Qtach	TKTW65	D+305

TW80 Qtach	TKTW65	D+305
Direct To Loader Boom Mounts		
TW80 Direct	TKTW80D	D+549
Terex	Part #	Price Code
Quick Attach Mounts		
TX51-19 Qtach	TX5119	D
TX55-19 Qtach	TX5119	D
TL60 Skidsteer Qtach	BO500	A
TL65 Skidsteer Qtach	BO500	A
TX66-41 Qtach	TX5119	D
TL70 Skidsteer Qtach	BO500	A
TL80 Qtach	TX844	D+305
TL100 Qtach	TX844	D+305
TL120 Qtach	TX844	D+305
SKL160 Qtach	TXSKL160Q	D+305
SKL200 Qtach	TXSKL160Q	D+305
SKL260 Qtach	TXSKL160Q	D+305
SKS633 Qtach	TX824	D+305
SKS634 Qtach	TX824	D+305
TX760 Qtach	JRBE	D+305
SKL821 Qtach	TX824	D+305
SKL823 Qtach	TX824	D+305
SKL824 Qtach	TX824	D+305
SKL831 Qtach	TX824	D+305
SKL832 Qtach	TX824	D+305
SKL833 Qtach	TX844	D+305
SKL834 Qtach	TX844	D+305
SKL835 Qtach	TX844	D+305
SKL841 Qtach	TX844	D+305
SKL843 Qtach	TX844	D+305
SKL844 Qtach	TX844	D+305
SKL851 Qtach	TX844	D+305
SKL853 Qtach	TX844	D+305
SKL854 Qtach	TX844	D+305
SKL863 Qtach	TXSKL863Q	D+305
SKL873 SP Qtach	VOL50Q	D+305
Direct To Loader Boom Mounts		
51-19 Direct	TX5119D	D
TL 65 Direct	TXTL65	D
TL 70 Direct	TXTL65	D
TL 80 Direct	TXTL80	D
TL 100 Direct	TXTL100	D
TL 120 Direct	TXTL100	D
SKS 631 Direct	TXTL65	D
SKS 633 Direct	TXTL65	D
SKS 634 Direct	TXTL65	D
TX760 Direct	TX760B	D
SKL 821 Direct	TXTL65	D
SKL 823 Direct	TXTL65	D
SKL 824 Direct	TXTL65	D
SKL 831 Direct	TXTL65	D
SKL 832 Direct	TXTL65	D
SKL 833 Direct	TXTL80	D
SKL 834 Direct	TXTL80	D
SKL 835 Direct	TXTL100	D
SKL 841 Direct	TXTL100	D
SKL 843 Direct	TXTL100	D
SKL 844 Direct	TXTL100	D
SKL 851 Direct	TXTL100	D
SKL 853 Direct	TXTL100	D
SKL 854 Direct	TXTL100	D

Loader Order Mounting Codes

SKL 861 Direct	TXSKL861	D+549
SKL 861A Direct	TXSKL863	D+549
SKL 861B Direct	TXSKL863	D+549
SKL 863 Direct	TXSKL863	D+549
SKL 871 Direct	TXSKL863	D+549
SKL 873 Direct	TXSKL873	D+549
SKL 873 HL Direct	TXSKL863	D+549
SKL 877 Direct	TXSKL863	D+549

Tym	Part #	Price Code
Quick Attach Mounts		
TX25 Qtach	BO500	A
TX39H Qtach	BO500	A
TX55 Qtach	BO500	A
TX75 Qtach	BO500	A
TX105 Qtach	BO500	A
LT200 Qtach	BO500	A
LT300 Qtach	BO500	A
LT400 Qtach	TYMLT400	A
LT451 Qtach	TYMLT400	A
LT600 Qtach	TYMLT400	A
LT700 Qtach	TYMLT400	A
TX2000 Qtach	BO500	A
Direct To Loader Boom Mounts		
T90 Direct	TYMT90	B

Universal	Part #	Price Code
UN9000 Direct	FRE8010	B

Valtra	Part #	Price Code
1080 Direct	AO675	B

Venieri	Part #	Price Code
5.63 Venieri Style Qtach (early models)	VE563QT	D+305
5.63 Venieri Style Qtach (later models)	VE763QT	D+305
7.63 Venieri Style Qtach	VE763QT	D+305
9.63 Venieri Style Qtach	VE763QT	D+305

Versatile	Part #	Price Code
Quick Attach Mounts		
256 Qtach	FO276	C
276 Qtach	FO276	C
NH7614 Qtach	NH7614	C
2360V Qtach	FO276	C
Direct To Loader Boom Mounts		
150 Direct	FO150	C
276 Direct	FO276D	C

Volvo	Part #	Price Code
Quick Attach Mounts		
L20 Ind Qtach	VOL20Q	D+305
L25 Ind Qtach	VOL20Q	D+305
L30 Ind Qtach	VOL30Q	D+305
L30B PRO Ind Qtach	VOL30Q	D+305
L35 Ind Qtach	VOL30Q	D+305
L35B PRO Ind Qtach	VOL30Q	D+305
L50 Ind Qtach	VOL50Q	D+305
L60 Ind Qtach	VOL50Q	D+305
BL70 Ind Qtach	VOL50Q	D+305
L70 Ind Qtach	VOL50Q	D+305
L90 Ind Qtach	VOL50Q	D+305

L110 Ind Qtach	VOL50Q	D+305
L120 Ind Qtach	VOL50Q	D+305
L150 Ind Qtach	VOL180Q	D+549
L180 Ind Qtach	VOL180Q	D+549
L220 Ind Qtach	VOL220Q	D+793

Direct To Loader Boom Mounts		
L45 Direct	VOL45D	D
BL70 Ind Direct	VOBL70	D

Wacker Neuson	Part #	Price Code
Quick Attach Mounts		
WL50 Hook Style Qtach	WNWL50	D+305
WL60 Hook Style Qtach	WNWL60	D+305
WL95 Hook Style Qtach	VOL50Q	D+305
WL850 Hook Style Qtach	GE480	D+305
WL1150 Hook Style Qtach	GE680	D+305
Direct To Loader Boom Mounts		
8085T Direct	WN8085T	D+305
TH627 Direct	WNTH627	D+305

Weideman	Part #	Price Code
Quick Attach Mounts		
1160 Qtach	WE1160	D+305
Direct To Loader Boom Mounts		
5080T Direct	WE5080TD	D+305

Westendorf	Part #	Price Code
Quick Attach Mounts		
WL-21 Qtach	WE20Q	B
WL-22 Qtach	WE20Q	B
WL-23 Qtach	WE20Q	B
WW-24 Qtach	WE20Q	B
TA-26 Qtach	WE20Q	B
WL-27 Qtach	WE20Q	B
WL-28 Qtach	WE20Q	B
TA-29 Qtach	WE20Q	B
WL-30 Qtach	WE40Q	B
WL-40 Qtach	WE40Q	B
WL-42 Qtach	WE40Q	B
WL-44 Qtach	WE40Q	B
TA-45 Qtach	WE40Q	B
TA-46 Qtach	WE40Q	B
TA-48 Qtach	WE40Q	B
WL-60 Qtach	WE40Q	B
WL-61 Qtach	WE40Q	B
WL-64 Qtach	WE40Q	B
TA-76 Qtach	WE70Q	B
TA-77 Qtach	WE70Q	B
WL-357 Qtach	WE40Q	B
XTA-400 Qtach	WE40Q	B
WL-457 Qtach	WE40Q	B
WL-467 Qtach	WE70Q	B
WL-576 Qtach	WE70Q	B
XTA-700 Qtach	WE70Q	B

Direct To Loader Boom Mounts		
WL21 Direct	WEWL21D	B
TA26 Direct	WETA26	B

White	Part #	Price Code
120 Direct	KM130	B

Loader Order Mounting Codes

130 Direct	KM130	B
132 Direct	KM132	B
140 Direct	KM130	B
1170 Direct	WH1170	B
1514 Direct	WH1514	B
1522 Direct	WH1522	C
1524 Direct	WH1524	B
1534 Cockshutt Direct	KM130	B
1730 Direct	WH1730	B

Wille	Part #	Price Code
365 Qtach	WIKU500	D+305

Wilmar	Part #	Price Code
4500 Qtach	BO500	A
4550 Qtach	BO500	A

Woods	Part #	Price Code
Quick Attach Mounts		
LC96 Qtach	BO500	A
LC102 Qtach	BO500	A
LC108 Qtach	BO500	A
110 Qtach	WO215	B
115 Qtach	WO215	B
200 Qtach	WO215	B
205 Qtach	WO215	B
210 Qtach	WO215	B
215 Qtach	WO215	B
255 Qtach	WO215	B
260 Qtach	WO215	B
275 Qtach	WO215	B
305 Qtach	WO215	B
310 Qtach	WO215	B
1016 Qtach	BO500	A
1020 Qtach	BO500	A
1027 Qtach	BO500	A

Direct To Loader Boom Mounts		
LS84 Direct	WOLS84	B
LC96 Direct	WOLC96	C
LF138 Direct	WOLF138	B
LF156 Direct	WOLF138	B
1008 Direct	WO1008	B
1020 Direct	WO1020	B
1027 Direct	WO1020	B
3100 Direct	WO3100	B

Yanmar	Part #	Price Code
Quick Attach Mounts		
YL110 Qtach	YAYL210Q	B
YL210 Qtach	YAYL210Q	B
YL300 Qtach	YAYL300Q	B
YL310 Qtach	BO500	A
YL610 Qtach	BO500	A
V8 Terex Style Qtach	TX844	D+305
V8 ISO Style Qtach	JD244J	D+305
V10 Terex Style Qtach	TX844	D+305
V10 ISO Style Qtach	JD244J	D+305
V12 Terex Style Qtach	TX844	D+305
V12 ISO Style Qtach	JD244J	D+305
Direct To Loader Boom Mounts		
V3 Direct	YANV45	D

V4-5 Direct	YANV45	D
V4-6 Direct	YANV45	D
V4-7 Direct	YANV45	D
YL110 Direct	YAYL210	B
YL210 Direct	YAYL210	B
CL300 Direct (2008 and earlier)	CCCL300	B
YL300 Direct	YAYL300D	B
V8 Direct	TXTL80	D
V10 Direct	TXTL100	D
V12 Direct	TXTL100	D

Zetor	Part #	Price Code
Quick Attach Mounts		
FL-231-100 Qtach	AO600	A
FL-231-101 Qtach	AO600	A
ZL31 Qtach	AO600	A
ZX4.1P Qtach	AO600	A
Direct To Loader Boom Mounts		
ZX4.1P DM Direct	AOQ55DM	B

Skidsteer Order Mounting Codes

SKIDSTEER ORDER MOUNTING CODES

ASV	Part #	Price Code
Quick Attach Mounts		
RT25 Qtach	ASV30Q	B
RC30 Qtach	ASV30Q	B
RT40 Qtach	ASV30Q	B
RC50 Qtach	BO500	A
RC60 Qtach	BO500	A
Direct To Loader Boom Mounts		
RC30 Direct	ASV30D	B
RT30 Direct	TXPT30	C
RT40 Direct	TXPT30	C
PT50 Direct (#PTC02882-Current)	ASVSR70	C
RC50 Direct (0 - #RSC02286)	ASVRC50	B
RC50 Direct (#RSC02287 - END)	ASVSR70	C
PT60 Direct (#PTE02260-Current)	ASVSR70	C
RC60 Direct (#RSE01596-Current)	ASVSR70	C
PT70 Direct (#PTH00608-Current)	ASVSR70	C
SR70 Direct	ASVSR70	C
PT80 Direct (#PTI01082-Current)	ASVSR70	C
SR80 Direct (#SEA-SEB00101-Current)	ASVSR70	C

Baumalight	Part #	Price Code
Quick Attach Mounts		
TRL620D Qtach	RR800	A
TRL620Y Qtach	RR800	A
WRL58G Qtach	RR800	A

Bobcat	Part #	Price Code
Quick Attach Mounts		
MT55 Qtach	BO463	A
S70 Qtach	BO463	A
440 Qtach	BO440	B
443 Qtach	BO440	B
450 Qtach	BO440	B
453 Qtach	BO440	B
463 Qtach	BO463	A
465 Qtach	BO500	A
500 thru 800 Series Qtach	BO500	A
943 Qtach	BO943	B
963-G Series Qtach	BO500	A
975 Qtach	BO975	B
985 Qtach	BO975	B

Direct To Loader Boom Mounts		
T140 Direct	BOT140	C
S150 Direct	BOT190	C
S160 Direct	BOT190	C
S175 Direct before 2003	BO773	C
S175 Direct after 2003	BOT190	C
T180 Direct	BOT190	C
S185 Direct before 2003	BO773	C
S185 Direct after 2003	BOT190	C
T190 Direct before 2003	BO773D	C
T190 Direct after 2003	BOT190	C
S205 Direct	BOT190	C
S250 Direct	BOS250	C
S570 Direct	BOS590	C
S590 Direct	BOS590	C
S650 Direct	BOS650	C
T750 Direct	BOT750	C
T770 Direct	BOT750	C

773 Direct (Double Cylinder)	BO773	C
825 Direct	BO825	C
S850 Direct	BOS850	C
873 Direct	BO873	C
943 Direct	BO953D	C
953 Direct	BO953D	C
975 Direct	BO975D	C

Bulldog	Part #	Price Code
B4230CS1 Qtach	BD4230CS1	A

Case IH	Part #	Price Code
Quick Attach Mounts		
40XT Qtach	BO500	A
60XT Qtach	BO500	A
70XT Qtach	BO500	A
75XT Qtach	BO500	A
85XT Qtach	BO500	A
95XT Qtach	BO500	A
SR130 Qtach	BO500	A
SR150 Qtach	BO500	A
SR175 Qtach	BO500	A
SV185 Qtach	BO500	A
SR200 Qtach	BO500	A
SR220 Qtach	BO500	A
SR250 Qtach	BO500	A
SV250 Qtach	BO500	A
TR270 Qtach	BO500	A
SV300 Qtach	BO500	A
TR320 Qtach	BO500	A
TV380 Qtach	BO500	A
410 Qtach	BO500	A
420 Qtach	BO500	A
420CT Qtach	BO500	A
430 Qtach	BO500	A
435 Qtach	BO500	A
435CT Qtach	BO500	A
440 Qtach	BO500	A
440CT Qtach	BO500	A
445CT Qtach	BO500	A
445 Qtach	BO500	A
450 Qtach	BO500	A
450CT Qtach	BO500	A
465 Qtach	BO500	A
1530 Qtach	CI1530	B
1740 Qtach	CI1740	B
1816C Qtach	CI1816C	B
1818 ToolTach	CI1818T	B
1825 ToolTach	CI1818T	B
1830 Qtach	CI1830	B
1830 ToolTach	CI1835T	B
1835 ToolTach	CI1835T	B
1838 Qtach	BO500	A
1840 Qtach	BO500	A
1840 ToolTach	CI1835T	B
1845 ToolTach	CI1845T	B
1845C Qtach	BO500	A

Direct To Loader Boom Mounts		
40XT Direct	CI40XT	B
60XT Direct	CI40XT	B
70XT Direct	CI40XT	B
75XT Direct	CI85XT	B

Skidsteer Order Mounting Codes

SKIDSTEER ORDER MOUNTING CODES

85XT Direct	CI85XT	B
90XT Direct	CI85XT	B
95XT Direct	CI85XT	B
SR130 Direct	CISR150	B
SR150 Direct	CISR150	B
SR175 Direct	CISV185	B
SV185 Direct	CISV185	B
SR200 Direct	CISV185	B
SR220 Direct	CISV185	B
SR250 Direct	CISV185	B
SV250 Direct	CISV185	B
TR270 Direct	CISV185	B
SV300 Direct	CISV185	B
TV380 Direct	CISV185	B
410 Direct	CI40XT	B
420 Direct	CI40XT	B
420CT Direct	CI40XT	B
430 Direct	CI40XT	B
435 Direct	CI85XT	B
435CT Direct	CI85XT	B
440 Direct	CI40XT	B
440CT Direct	CI40XT	B
445CT Direct	CI85XT	B
445 Direct	CI85XT	B
450 Direct	CI85XT	B
450CT Direct	CI85XT	B
465 Direct	CI85XT	B
1818 Direct	CI1818D	B
1825 Direct	CI1825D	B
1830 Direct	CI1835D	B
1835 Direct	CI1835D	B
1835B Direct	CI1835D	B
1835C Direct	CI1835D	B
1838 Direct	CI1838D	B
1840 Direct	CI1840D	B
1845 Direct	CI1845D	B
1845B Direct	CI1845D	B

Caterpillar	Part #	Price Code
Quick Attach Mounts		
All 200 Series Qtach	BO500	A
Direct To Loader Boom Mounts		
262C Direct	CA262C	C

Ford	Part #	Price Code
CL45 Qtach	TH133	B
CL55 Qtach	TH233	B

Gehl	Part #	Price Code
Quick Attach Mounts		
Avantage AL20 Qtach	GEAL20	A
R105 Qtach	BO500	A
R135 Qtach	BO500	A
R150 Qtach	BO500	A
R165 Qtach	BO500	A
R190 Qtach	BO500	A
R220 Qtach	BO500	A
R260 Qtach	BO500	A
V270 Qtach	BO500	A
V330 Qtach	BO500	A
V420 Qtach	BO500	A
1640 Qtach	BO463	A

3410 Qtach	GE3610	B
3510 Qtach	GE3610	B
3610 Qtach	GE3610	B
3615 Qtach	GE3610	B
3635 Qtach	BO500	A
SL3635 Qtach	BO500	A
3725 Qtach	GE3825	B
3825 Qtach	GE3825	B
3935 Qtach	BO500	A
SL3935 Qtach	BO500	A
4300 Qtach	GE4300	B
4510 Qtach	GE4610	B
4610 Qtach	GE4610	B
4615 Qtach	GE4610	B
4625 Qtach	BO500	A
4625 Qtach (Old Style)	GE4625	B
4635 Qtach	BO500	A
4635 Qtach (Old Style)	GE4625	B
4640 Qtach	BO500	A
4835 Qtach	BO500	A
4835 Qtach (Old Style)	GE4625	B
4840 Qtach	BO500	A
5620 Qtach	BO500	A
5620 Qtach (Old Style)	GE4625	B
5625 Qtach	BO500	A
5625 Qtach (Old Style)	GE4625	B
5635 Qtach	BO500	A
5635 Qtach (Old Style)	GE4625	B
5640 Qtach	BO500	A
6625 Qtach	BO500	A
6625 Qtach (Old Style)	GE4625	B
6635 DXT Qtach	BO500	A
6635 DXT Qtach (Old Style)	GE4625	B
6635 SXT Qtach	BO500	A
6635 SXT Qtach (Old Style)	GE4625	B
6640 Qtach	BO500	A

Direct To Loader Boom Mounts		
CTL80 Direct	GECTL80	D
R190 Direct	GER190	C
R220 Direct	GEV330	C
V270 Direct	GEV330	C
V330 Direct	GEV330	C
3310 Direct	GE3410D	B
3410 Direct	GE3410D	B
3510 Direct	GE3410D	B
3515 Direct	GE3410D	B
3610 Direct	GE3410D	B
3615 Direct	GE3410D	B
3640 Direct	GE4240D	B
3825 Direct	GE3825D	B
3840 Direct	GE4240D	B
3935 Direct	GE3935D	B
4240 Direct	GE4240D	B
4610 Direct	GE4610D	C
4625 Direct	GE4625D	C
4635 Direct	GE4840	C
4640 Direct	GE4840	C
4840 Direct	GE4840	C
4835 Direct	GE4840	C
5240 Direct	GE4840	C
5635 Direct	GE6640	C
5640 Direct	GE6640	C

Skidsteer Order Mounting Codes

SKIDSTEER ORDER MOUNTING CODES

6640 Direct	GE6640	C
JCB		
Part #	Price Code	
Quick Attach Mounts		
165 Qtach	BO500	A
185 Qtach	BO500	A
1105 Qtach	BO500	A
1110 Qtach	BO500	A
Direct To Loader Boom Mounts		
160 Direct	JC160	D
170 Direct	JC160	D
John Deere		
Part #	Price Code	
Quick Attach Mounts		
240 Qtach	BO500	A
250 Qtach	BO500	A
260 Qtach	BO500	A
270 Qtach	BO500	A
280 Qtach	BO500	A
313 Qtach	BO500	A
315 Qtach	BO500	A
CT315 Qtach	BO500	A
317 Qtach	BO500	A
318D Qtach	BO500	A
319D Qtach	BO500	A
320 Qtach	BO500	A
320D Qtach	BO500	A
CT322 Qtach	BO500	A
323D Qtach	BO500	A
325 Qtach	BO500	A
326D Qtach	BO500	A
328 Qtach	BO500	A
328D Qtach	BO500	A
329D Qtach	BO500	A
332 Qtach	BO500	A
332D Qtach	BO500	A
CT332 Qtach	BO500	A
333D Qtach	BO500	A
375 Qtach	NH250	B
570 Qtach	NH455	B
575 Qtach	NH455	B
675 Qtach	NH555	B
675B Qtach	NH555	B
3375 Qtach	NH250	B
4475 Qtach	BO500	A
5575 Qtach	BO500	A
6675 Qtach	BO500	A
7775 Qtach	BO500	A
8875 Qtach	BO500	A
Direct To Loader Boom Mounts		
240 Direct	JD250	B
250 Direct	JD250	B
260 Direct	JD260S	B
270 Direct	JD260S	B
280 Direct	JD260S	B
317 Direct Serial# 0 - 114864	JD250	B
317 Direct Serial# 114865 - END	JD320	B
312GR Direct	JD317G	C
314G Direct	JD317G	C
316GR Direct	JD317G	C
317G Direct	JD317G	C

318D Direct	JD318D	B
318G Direct	JD317G	C
319D Direct	JD318D	B
320D Direct	JD318D	B
320 Direct Serial# 0 - 114864	JD250	B
320 Direct Serial# 114865 - END	JD320	B
CT322 Direct	JD320	B
323D Direct	JD318D	B
325 Direct	JD260S	B
326D Direct	JD326D	C
326E Direct	JD326D	C
328 Direct	JD260S	B
328D Direct	JD326D	C
328E Direct	JD326D	C
329D Direct	JD326D	C
329E Direct	JD326D	C
332 Direct	JD260S	B
332D Direct	JD326D	C
332E Direct	JD326D	C
333D Direct	JD326D	C
333E Direct	JD326D	C
575 Direct	NH455D	C
6675 Direct	NH160	B

Komatsu		
Part #	Price Code	
Quick Attach Mounts		
CK35 Qtach	BO500	A
SK815 Qtach	BO500	A
SK820 Qtach	BO500	A
Direct To Loader Boom Mounts		
CK35 Direct	KOMCK35	C
SK815-5 Direct	KOMSK820	C
SK820-5 Direct	KOMSK820	C
SK1026-5 Direct	KOMSK1026	C

Kubota		
Part #	Price Code	
Quick Attach Mounts		
SSV75 Qtach	BO500	A
SVL75 Qtach	BO500	A
SVL75-2 Qtach	BO500	A
SVL90 Qtach	BO500	A
SVL90-2 Qtach	BO500	A
Direct To Loader Boom Mounts		
SSV75 Direct	KUSSV75	D
SVL75 Direct	KUSVL90	D

Manitou		
Part #	Price Code	
Quick Attach Mounts		
1050R Qtach	BO500	A
1350R Qtach	BO500	A
1500R Qtach	BO500	A
1650R Qtach	BO500	A
1900R Qtach	BO500	A
2200R Qtach	BO500	A
2600R Qtach	BO500	A
2700V Qtach	BO500	A
3300V Qtach	BO500	A
4200V Qtach	BO500	A
Direct To Loader Boom Mounts		
1900R Direct	GER190	C

Skidsteer Order Mounting Codes

SKIDSTEER ORDER MOUNTING CODES

2200R Direct	GEV330	C
2700V Direct	GEV330	C
3300V Direct	GEV330	C

Mustang	Part #	Price Code
Quick Attach Mounts		
342 Qtach	MU442	C
345 Qtach	MU442	C
440 Qtach	MU442	C
441 Qtach	MU442	C
442 Qtach	MU442	C
445 Qtach	MU442	C
552 Qtach	MU442	C
930 Qtach	MU442	C
930A Qtach	MU442	C
940 Qtach	MU442	C
960 Qtach	MU442	C
1200 Qtach	MU442	C
1700 Qtach	MU442	C
2040 Mustang Qtach	MU442	C
2040 Universal Qtach	BO500	A
2050 Mustang Qtach	MU442	C
2050 Universal Qtach	BO500	A
2060 Mustang Qtach	MU442	C
2060 Universal Qtach	BO500	A
2070 Mustang Qtach	MU442	C
2070 Universal Qtach	BO500	A

Direct To Loader Boom Mounts		
938 Direct	MU938	C
940 Direct	MU940	C
2054 Direct	MU2054	C

New Holland	Part #	Price Code
Quick Attach Mounts		
L35 Qtach	NH555	B
L120 Qtach	NH250	B
LS120 Qtach	NH250	B
L125 Qtach	NH250	B
LS125 Qtach	NH250	B
LS Series 140-190 Qtach	BO500	A
L213 Qtach	BO500	A
L215 Qtach	BO500	A
L216 Qtach	BO500	A
L218 Qtach	BO500	A
L220 Qtach	BO500	A
L223 Qtach	BO500	A
L225 Qtach (2011 & Newer)	BO500	A
C227 Qtach	BO500	A
L230 Qtach	BO500	A
C232 Qtach	BO500	A
C238 Qtach	BO500	A
L250 Qtach	NH250	B
L255 Qtach	NH250	B
L325 Qtach	NH455	B
L425 Qtach	NH455	B
L445 Qtach	NH455	B
L454 Qtach	NH455	B
L455 Qtach	NH455	B
L465 Qtach	BO500	A
LX465 Qtach	BO500	A
LX485 Qtach	BO500	A

L553 Qtach	NH555	B
L555 Qtach	NH555	B
L565 Qtach	BO500	A
LX565 Qtach	BO500	A
LX665 Qtach	BO500	A
L775 Qtach	NH555	B
L781 Qtach	NH555	B
L783 Qtach	NH555	B
L785 Qtach	NH555	B
L865 Qtach	BO500	A
LX865 Qtach	BO500	A
LX885 Qtach	BO500	A
LX985 Qtach	BO500	A

Direct To Loader Boom Mounts		
L35 Direct	NH785	C
L140 Direct	NH140	B
LS140 Direct	NH140	B
L150 Direct	NH140	B
LS150 Direct	NH140	B
L160 Direct	NH160	B
LS160 Direct	NH160	B
L170 Direct	NH160	B
LS170 Direct	NH160	B
C175 Direct	NH160	B
L175 Direct	NH160	B
L180 Direct	NH160	B
LS180 Direct	NH160	B
LS180.B Direct	NH160	B
L185 Direct	NH160	B
C190 Direct	NH160	B
L190 Direct	NH160	B
LS190 Direct	NH160	B
LS190.B Direct	NH160	B
L213 Direct	CISR150	B
L215 Direct	CISR150	B
L216 Direct	CISR150	B
L218 Direct	CISV185	B
L220 Direct	CISV185	B
L223 Direct	CISV185	B
L225 Direct (2011 & Newer)	CISV185	B
C227 Direct	CISV185	B
L228 Direct	CISV185	B
C232 Direct	CISV185	B
C238 Direct	CISV185	B
L230 Direct	CISV185	B
250 Direct	NH250D	B
455 Direct	NH455D	C
L465 Direct	NH140	B
LX465 Direct	NH140	B
LX485 Direct	NH140	B
553 Direct	NH555D	C
555 Direct	NH555D	C
LX565 Direct	NH160	B
LX665 Direct	NH160	B
L775 Direct	NH785	C
L781 Direct	NH785	C
L783 Direct	NH785	C
L784 Direct	NH785	C
L785 Direct	NH785	C
LX865 Direct	NH160	B
LX885 Direct	NH160	B
LX985 Direct	NH160	B

Skidsteer Order Mounting Codes

SKIDSTEER ORDER MOUNTING CODES

Ramrod	Part #	Price Code
800 Qtach	RR800	A
910 Qtach	RR800	A

Takeuchi	Part #	Price Code
TL10 Qtach	BO500	A

Terex	Part #	Price Code
-------	--------	------------

Quick Attach Mounts		
RT25 Qtach	ASV30Q	B
PT30 Qtach	ASV30Q	B
R070T Qtach	ASV30Q	B

Direct To Loader Boom Mounts		
PT30 Direct (0 - DTA05000)	ASV30D	B
PT30 Direct (DTA05001 - END)	TXPT30	C
PT50 Direct (#03056-Current)	ASVSR70	C
PT60 Direct (#02662-Current)	ASVSR70	C
PT70 Direct (#DTH00682-Current)	ASVSR70	C
PT75 Direct (#01032-Current)	ASVSR70	C
PT80 Direct (#01310-Current)	ASVSR70	C

Thomas	Part #	Price Code
--------	--------	------------

Quick Attach Mounts		
25GT Qtach	RR800	A
25GW Qtach	RR800	A
35DT Qtach	RR800	A
35DW Qtach	RR800	A
T95 Qtach	BO500	A
103S Qtach	BO500	A
T105 Qtach	BO500	A
T115 Qtach	BO500	A
133 Qtach	TH133	B
133S Qtach	BO500	A
135 Qtach	BO500	A
153 Qtach	BO500	A
170 Qtach	TH233	B
173 Qtach (Old Style)	TH233	B
173 Qtach (New Style)	BO500	A
175 Qtach	BO500	A
233 Qtach (Old Style)	TH233	B
233 Qtach (New Style)	BO500	A
243 Qtach	BO500	A
245 HDK Qtach	BO500	A
1220 Qtach	TH1220	B
Pro Tuff 1300 Qtach	BO500	A
Pro Tuff 2200 Qtach	BO500	A

Direct To Loader Boom Mounts		
133 Direct	TH133D	C
135 Direct	TH135D	C

Toro Dingo	Part #	Price Code
------------	--------	------------

Quick Attach Mounts		
TX525	RR800	A

Direct To Loader Boom Mounts		
TX525 Direct	TORTX525	B

Vermeer	Part #	Price Code
---------	--------	------------

S450TX Qtach	RR800	A
S650TX Qtach	RR800	A
S750TX Qtach	RR800	A

S800TX Qtach	RR800	A
--------------	-------	---

Volvo	Part #	Price Code
Qtach	BO500	A

Yanmar	Part #	Price Code
S190R Qtach	BO500	A

Dealer: _____

Name: _____

Phone # _____

Fax # _____

Direct Pin-On Specs

Note: Dimensions must be taken from loader/skidsteer bucket. The following measurements are required

Loader Model # _____

Please verify where your measurements were taken:

- From loader bucket
 From other attachment

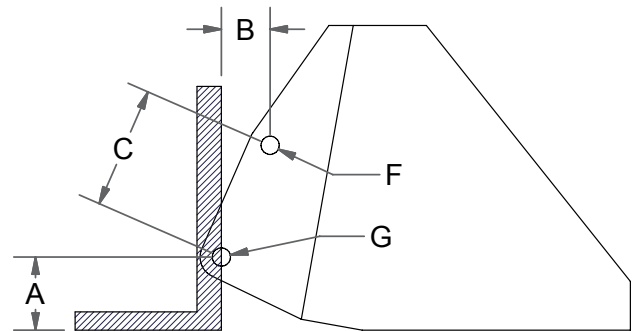
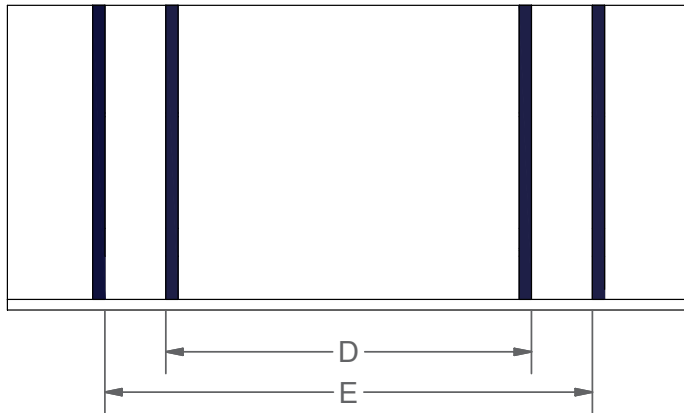

a) Bottom pin to ground _____

b) Pin lead _____ Note: Pin lead must be taken 90° to ground or bottom of bucket

c) Pin centres _____

d) Inside hitchplates _____

e) Outside hitchplates _____

f) Top pin diameter _____

g) Bottom pin diameter _____

Distributed by



Batavia NY 100-120 Lehigh Ave. PO Box 928 14021-0928

phone 585.343.5411 or **fax** 585.343.0346

Carlisle PA 100 Stover Dr. 17015

phone 717.249.6720 or **fax** 717.249.9384

support@cummingsandbricker.com

www.cummingsandbricker.com



www.horstwelding.com | www.hlaattachments.com